

The logo for ZIEHER, featuring the word "ZIEHER" in a bold, black, sans-serif font. A pink arc is positioned above the letters "I" and "E", partially overlapping them.

ZIEHER



2024
PROFESSIONAL



Dear Customers, dear Friends,

I am delighted to present to you today the new Zieher Catalogue for 2024.

In recent years, higher prices due to cost increases in many areas as well as very high inflation have unfortunately been unavoidable. I am all the more pleased to inform you today that we have been able to reduce these prices for a large portion of our products.

Join me in exploring numerous novelties in the Tabletop and Buffet categories: "Scala" creates clear delineations of available spaces and exudes an industrial flair with a touch of glamour. The miniature tables from the "Époques" series celebrate the style elements of past eras and, through innovative construction, prove to be exceedingly versatile and highly flexible in daily use. A floral and playful variant of food presentation is made possible by "Fleur Déco". The sculptural étagères are entirely made of brass and perfected in artistic craftsmanship – an homage to the beauty of nature!

I now wish you much pleasure in discovering these and other novelties.

Should you have any questions, suggestions, or specific product requests, I am at your disposal at any time.

Best regards,
Dominik Zieher



d.zieher@zieher.com
+49 151 40100321



For all information about Zieher, as well as all catalogues for download or as an interactive online version, please visit WWW.ZIEHER.COM

CONTENT

7

Buffet

Buffet displays "Scala" – "Époques" – "Stompl" – "Sagano"
"Glow" – "Textura" – "Somnia" – "Crossline"
Buffet systems "Curve" – "Skyline" – "Squareline"
The Zieher-System: "Solid" – "Luxor" – "V12 – Carbon"
"Konkret!" – "Classy" – "Neo" – "Lightning Buffet" – cooling element "Chiller-Base",
Buffet platters made of laminated plastic, glass and slate, buffet steps made of glass
Buffet bowls made of pewter, brass, shell, stainless steel and glass
Buffet étagères made of stainless steel and brass, e. g. "Fleur Déco", "Fingerfood-Tree"
Buffet stands "Mikado", "Stablo" and "Falcon"
Serving trays and buffet systems made of walnut: "Mercato" – "Solid"



Catering

"Bento Box", melamine trays and accessories
Serving trays and cutlery boxes made of walnut and melamine
Tray system "Modul": walnut – melamine – glass and china inserts

139

China, glass and more

Main series and small series made of china, ceramics and glass, e. g. "Ombra" – "Linea" – "Bosque"
Porcelain plates, bowls and dishes
Glass plates, platters, bowls and dishes
Pewter napkin rings, charger plates, glass cloches



155

Wine glasses, decanter, bar and more

Wine glass series VISION and "Tesoro", an aid to wine enjoyment
Wine decanter "Doppio" – "Star" – "Star-mini" – "Eddy" – "Eddy-mini" – "Pebble"
Base ring with LED for decanter "Star" and "Eddy", decanter cooler "On the Rocks"
Drying racks "DryPod" and "Stablo"
Champagne cooler "Stablo" and "Mikado"
"The Bar Collection"

198



231

Miniatures

Anti-slip coasters made of silicone
Miniatures made of pewter and borosilicate glass
Miniatures made of glass, china, stainless steel and melamine
Skewers and natural stone platters



Cruet stands, trays, étagères and more

"Bento Box" made of melamine, trays made of melamine and wood
Chocolate/truffles boxes, suitable inserts made of solid surface material
Trays and serving platters made of walnut, displays and trays made of brass
Étagères and racks made of brass and stainless steel, jam trays and food displays
Cruets and trays with suitable inserts, bread boxes/baskets
Wind lights and accessories

253



297

Room service, hotel room

Roomservice trays and accessories
Storage/presentation boxes, cutlery box "Solid"
Shelves and étagères, display "DryPod" and "Fleur Déco"



List of items in ascending order, Table of contents

308

Excellence since 1986

Exclusive design since 2006

In the year 2006 we designed the first items ourselves and placed them on the market.

Since that time developing and implementing exclusive design objects has been our calling. On this page we show a couple of the most important creations of the past years.

Design, innovation and quality are our mission!



2006



2008



2021



2022



2023



2024



2011



2010



2009



2020



2019



2018



2012



2013



2014

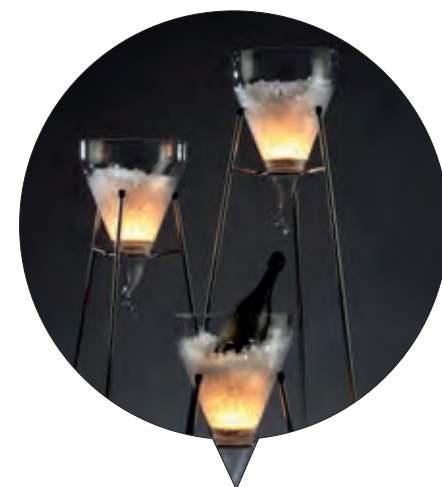

2015



2016



2017



"Linea" | p. 172/173

2024 Novelties



"Fleur Déco" | p. 96-99



"On The Rocks" | p. 221

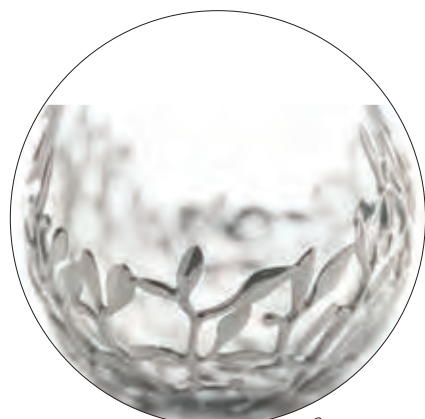

"Leaf" | p. 73



"Époques" | p. 12-15



"Ombra" | p. 158

Buffet



"Scala" is a series of displays made from cast aluminium and subsequently refined. The raw and industrial character of these products is intentionally chosen and reminiscent of roughly cast steel parts with a rustic yet modern flair.

This design feature is also reflected in the colour scheme. "Scala" is available in various shades of grey and dark silver, offering exciting nuances in tone and brightness. The 10 cm tall display is also available in a golden variant.

Whether in a rustic, industrial setting or with a touch of elegance and glamour, "Scala" offers countless possibilities for variation. Thanks to the hexagonal design and the various heights and colour options, buffet presentations can be continuously reimagined and flexibly staged.



→ "Somnia" | p. 28

→ "Matrix" | p. 76

→ "Fleur Déco" | p. 96



NEW "Scala"

"Scala" NEW

The hexagonal shape allows for efficient and space-saving partitioning of areas into fixed sections. This enables an appealing and organized presentation of culinary creations on up to four levels. The flat, step-like structure provides good visibility and creates an aesthetic overall look. A unique feature is the 20 cm tall display, designed as a halved version. This allows for closing gaps at the rear end of the setup without losing valuable space.

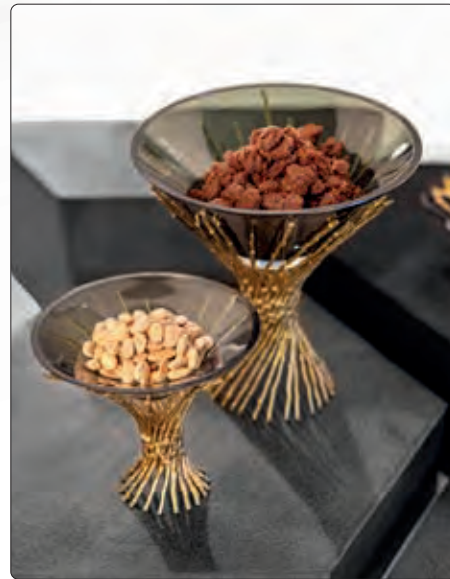

→ "Somnia" | p. 28



→ "Fleur Déco" | p. 96

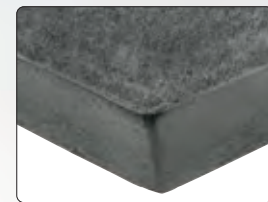

buffet display "Scala"

aluminium, structured, graphit, food-safe coating, splash-proof, bottom side open, not dishwasher-safe

item	l x w x h in cm
8430.05	50x43.5x5

buffet display "Scala"

aluminium, structured, golden coloured, food-safe coating, splash-proof, bottom side open, not dishwasher-safe

item	l x w x h in cm
8432.10	50x43.5x10

buffet display "Scala"

aluminium, structured, nickel-antique, food-safe coating, splash-proof, bottom side open, not dishwasher-safe

item	l x w x h in cm
8434.10	50x43.5x10

buffet display "Scala"

aluminium, structured, nickel-black, food-safe coating, splash-proof, bottom side open, not dishwasher-safe

item	l x w x h in cm
8436.15	50x43.5x15

buffet display "Scala"

aluminium, structured, graphit, food-safe coating, splash-proof, bottom side open, not dishwasher-safe

item	l x w x h in cm
8438.20	48.5x20.4x20

"Époques" - Timelessly Beautiful

The buffet system "Époques" combines the timeless beauty of classic style furniture with modern functionality and flexibility. This unique system consists of three miniature tables and an intricately turned column, which adapt numerous style elements from various eras of furniture construction. Each piece in this series is a one-of-a-kind, and though they are designed differently, they blend together in a remarkable way.

"Époques" is entirely crafted from solid wood. Antique-stained surfaces with food-safe sealing provide elegance and ensure the necessary durability for professional use.

These buffet pieces are exceptionally flexible, allowing for the quick and tool-free adjustment of the height of individual tables by fully or partially unscrewing the table legs. This results in various height options for customizing the buffet area. The central table can even be converted into four different heights, impressing with its versatility.

The buffet system "Époques" is a remarkable example of furniture design that pays homage to past eras while meeting the complex demands of the present - a historical tribute presented in a contemporary context!



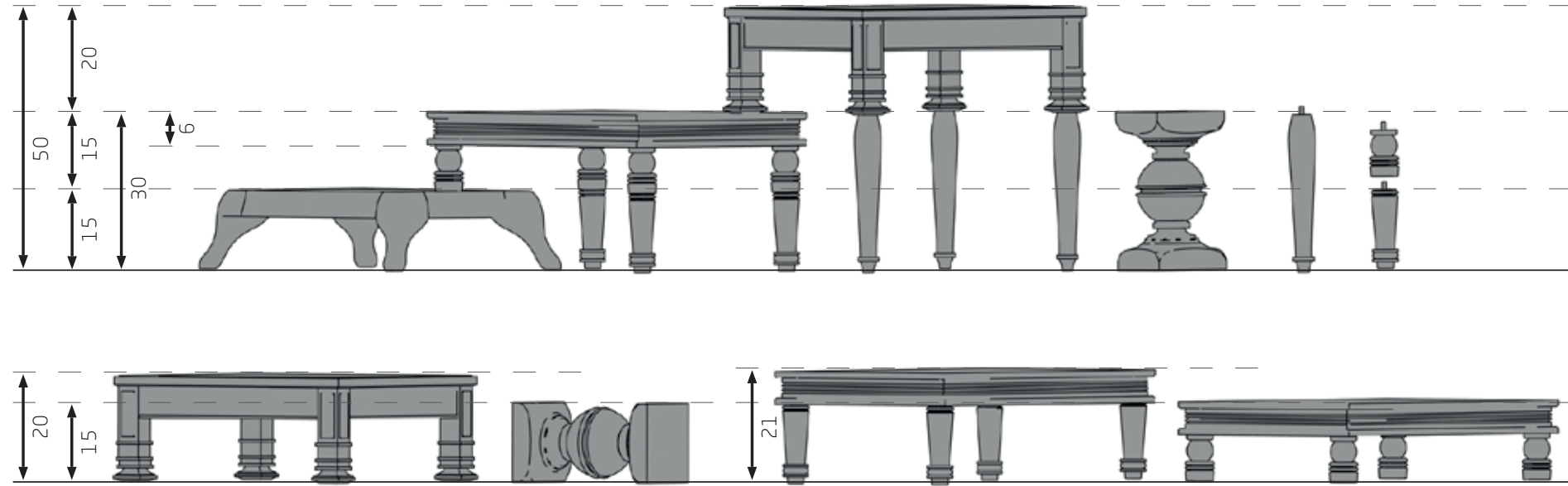

The special height grid also allows for partial shortening of individual table legs. This means that displays can be placed in nested arrangements to create different levels on the buffet. This not only creates visually appealing presentations but also enables more efficient utilization of the available space.

Please note:

Products made of massive wood are not dishwasher-safe. Do not immerse in water. Please note enclosed care instructions.

Standing height 30 cm | lying 15 cm



buffet display "Époques"

solid wood, dark stained, food-safe coating, standing and lying usable, not dishwasher-safe

item	l x w x h in cm
8253.30	15x15x30

Height 15 cm



buffet display "Époques"

solid wood, dark stained, food-safe coating, not dishwasher-safe

item	l x w x h in cm
8250.15	70x38x15



→ buffet platters "Ombra" | p. 57
→ glass series "Ombra" | p. 158



Timelessly beautiful

"Époques" combines the timeless beauty of classic style furniture with modern functionality and flexibility. These buffet pieces are exceptionally flexible, allowing for the quick and tool-free adjustment of the height of individual tables by fully or partially unscrewing the table legs.

Height 30 cm | optional: 6 cm | 15 cm | 21 cm



buffet display "Époques"

solid wood, dark stained, food-safe coating, feet demountable - thereby 4 heights possible, not dishwasher-safe

item	l x w x h in cm
8251.30	76x38x30

Please note:

The table legs of the medium and large table can be changed quickly and without tools.

Height 50 cm | optional: 20 cm



buffet display "Époques"

solid wood, dark stained, food-safe coating, feet demountable - thereby 2 heights possible, not dishwasher-safe

item	l x w x h in cm
8252.50	50x50x50



→ Brass trays "Orbis" | p. 75

→ Bowls "Fakir" | p. 76



charger plate

special hardened safety glass, 4 mm thick, round, polished rim, dishwasher-safe, rubber feet included (adhesive), underside scratch-proof

item	version	Ø in cm
1669.33	black glass	33
1671.33	white glass	33

coaster/glass insert

clear glass, 4 mm thick, round, edge polished and deburred, with 4 transparent silicone feet

item	Ø in cm
5244.28	28.2

buffet display "Stomp!"

resin, black, matt finish, translucent, solid oak wood, oiled, not dishwasher-safe

item	height in cm	Ø in cm
8240.08	8	27
8240.16	16	27
8240.24	24	27



Please note:

The buffet displays "Stomp!" are made of slightly translucent resin.

This ensures stunning effects, e.g. when used with illuminated buffet tables!



Oak wood is a natural product. Despite careful drying and selection of the pieces, cracks can form in the wood. These do not affect stability or function!

"Sagano" & "Stomp!" – Unique like nature!

The desire for individuality and handmade, unique pieces is perceptible in all sections of the hotel business. Besides distinctive elements in architecture and interior, guests should also experience uniqueness at the food presentation on the buffet.

"Stomp!" and "Sagano" (page 18/19) are taking up this trend and playfully connect it with the tamed power of nature.

Pieces of solid oak wood, split by an axe, carefully oiled and individually arranged form the basis of the "Stomp!" buffet displays. These ethnic elements of nature are cast in anthracite, but nevertheless slightly translucent resin and thus durably fixed in their arrangement. The silk matt finish of the dark coloured resin forms a harmonic contrast to the oiled oak wood. The combination of "Stomp!" with items made from solid brass results in a solemn, almost mystical atmosphere.

More information can be found on the following pages.





→ Ceramic "Bosque" | p. 156/157
→ Cloches | p. 192/193



"Sagano" & "Stomp!" – Unique like nature!

Contrary to "Stomp!" (page 16/17), "Sagano" fascinates by its playful airiness and filigree vibrancy. Feathery bamboo poles in different diameters are composed in white resin. Here, the visible rings on the top of the displays create diversified, almost graphical effects.

Both lines have the same concept, but the final appearance is quite the opposite and yet easy to combine. Each display is one of a kind and absolutely unique.

The resin used in both series is food-safe and was refined with a silk-matt finish and finally oiled. So in case of wear in daily use, the surfaces can easily be refreshed.

To protect these surfaces, but also to arrange food directly on the displays, optionally available glass platters can be placed on top if needed and can also be replaced by new ones quickly.



Please note:

Bamboo is a natural product. Despite careful drying and selection of the pieces, cracks can form in the poles. These do not affect stability or function!



Please note:

Coloured or clear glass platters can be attached to protect the surfaces. In order to ensure a secure hold, silicone feet can optionally be glued on.



charger plate

special hardened safety glass, 4 mm thick, round, polished rim, dishwasher-safe, rubber feet included (adhesive), underside scratch-proof

item	version	Ø in cm
1669.33	black glass	33
1671.33	white glass	33



coaster/glass insert

clear glass, 4 mm thick, round, edge polished and deburred, with 4 transparent silicone feet

item	Ø in cm
5244.28	28.2



buffet display "Sagano"

resin, white, matt finish, oiled, bamboo, not dishwasher-safe

item	height in cm	Ø in cm
8242.08	8	27
8242.16	16	27
8242.24	24	27





"Glow" – reframing the buffet!

Filigree displays and frames with integrated lighting form the basis of the "Glow" system.

The matt black coating of these slim but still extremely sturdy lighting objects remains discreetly in the background and leaves the presentation of dishes to the warm and glare-free light.

"Glow" is a flexible system that creates unmatched buffet stagings. The filigree construction not only allows food and beverages to be presented on the displays, their interior space also creates enough space to effectively present delicacies in the right light.

All elements can be used lying or upright and create presentation levels at different heights. This is the basis for varied and appealing buffet arrangements.

Two connecting boards made of bent sheet metal can be attached as desired and thus enable the flexible construction of several elements – even across corners. Matching buffet platters made of glass or laminated plastic, as well as trays made of melamine, complete the system.

Zieher buffet systems have been inspiring with innovative lighting concepts for many years. In "Glow", this is now firmly integrated for the first time. The resulting subtle look of these lighting objects creates completely new facets of atmospheric buffet ambiances.

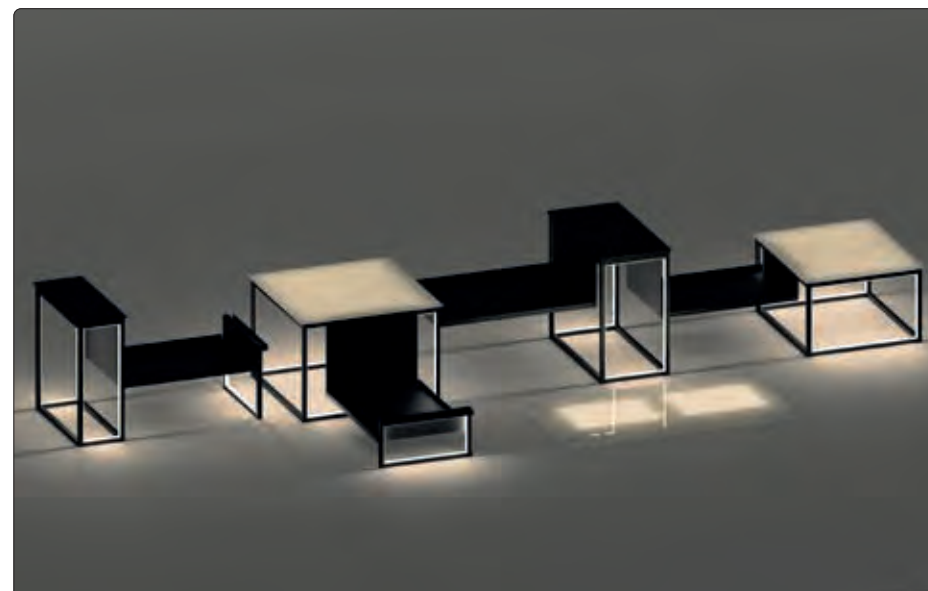
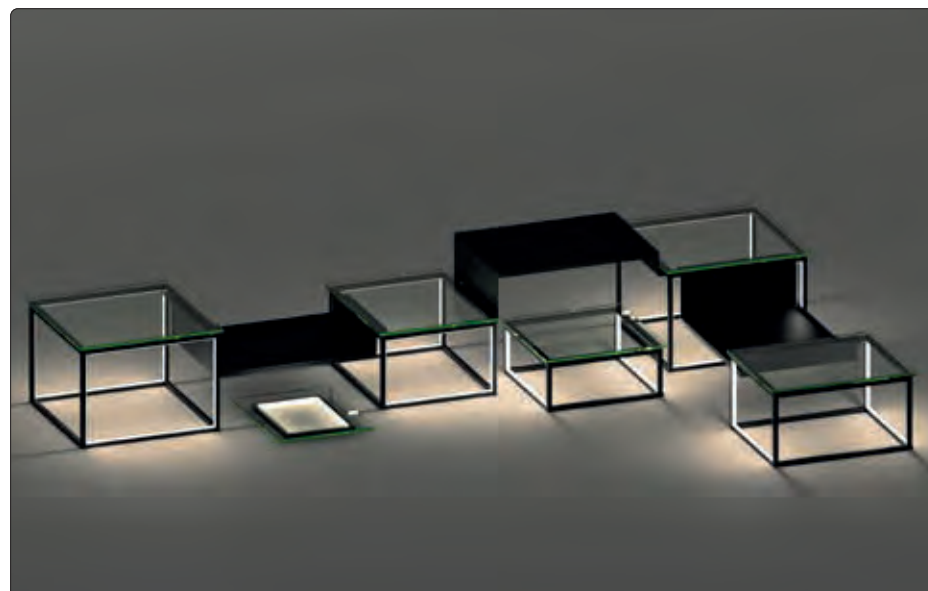

Components of the system:

- The illuminated cuboids offer, due to the two integrated connection sockets, the possibility of operating up to three elements on one power supply.
- Illuminated frames can be placed horizontally and thus enable the effective lighting of translucent buffet platters. When set up, they fit into the height grid of the buffet cuboids and thus function as a space-saving support for attached connecting boards.
- The connecting boards are made of powder-coated sheet metal and allow a two-sided use. They can simply be hung between the cuboids and frames, creating additional presentation levels and areas.
- Precisely fitting glass platters of various types and platters made of black laminated plastic make it possible to quickly and easily close the top of the illuminated cuboids. Various melamine trays from the range can also be used on some of the cubes. In the lying position, there is a large selection of suitable glass platters from the Zieher range available (50 x 50cm / 50 x 42cm / 42 x 42cm). These buffet platters are available on pages 56 to 63. If the cuboids are positioned upright, they can be covered with laminated plastic platters.
- Rubberised magnetic buffers ensure the non-slip and noiseless support of all platters and trays. These are available as accessories and can be placed anywhere on the displays and frames. Furthermore, they create the necessary distance in order to place glass or laminated plastic platters in spite of the attached connecting boards.



8400.16 + 8010.01



8400.24 + 8010.02



spacer/buffer
magnetic, black, rubberised, for non-slip and noiseless placement under buffet platters and trays on LED Displays GLOW (items 8400...)

item	Ø in cm	thickness in mm	PU
8414	1.7	4.4	4 pcs



connecting board "Glow" M
steel, matt black (powder coating), usable on both sides, for placement between 2 LED displays (items 8400...) and -frames (items 8405...)

item	l x w x h in cm
8410.24	55.2x32.6x24.2



connecting board "Glow" L
steel, matt black (powder coating), usable on both sides, for placement between 2 LED displays (items 8400...) and -frames (items 8405...)

item	l x w x h in cm
8410.16	63.2x36.6x16.2

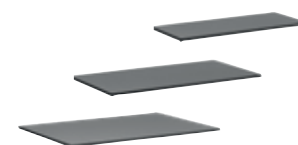

buffet platter, laminated plastic
laminated plastic, 8 mm thick, black, black intermediate ply, break-proof, scratch-proof, dishwasher-safe, antistatic, deburred edges, rounded corners

item	l x w in cm	for LED display
8010.01	41x17	S
8010.02	49x25	M
8010.03	49x33	L



LED frame "Glow"
steel, matt black (powder coating), with circumferential LED stripe (warmwhite), incl. connection socket for power supply

item	l x w in cm	size
8405.16	32x16	S
8405.24	32x24	M

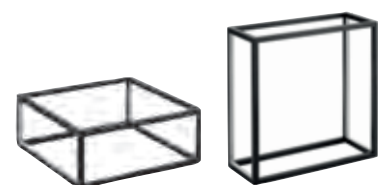

LED display "Glow" S
steel, matt black (powder coating), with 2 circumferential LED stripes (warmwhite), incl. 2 connection sockets for power supply and -forwarding

item	l x w x h in cm
8400.16	40x40x16

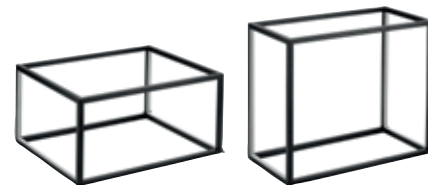

LED display "Glow" M
steel, matt black (powder coating), with 2 circumferential LED stripes (warmwhite), incl. 2 connection sockets for power supply and -forwarding

item	l x w x h in cm
8400.24	48x40x24

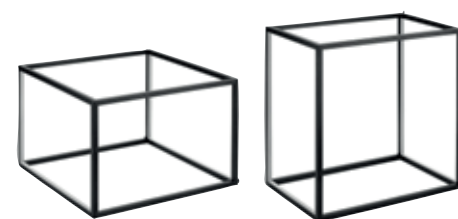

LED display "Glow" L
steel, matt black (powder coating), with 2 circumferential LED stripes (warmwhite), incl. 2 connection sockets for power supply and -forwarding

item	l x w x h in cm
8400.32	48x48x32





Accessories LED lighting:

- The power supplies are available with EU, US and UK plugs. The power of the supplies is sufficient to connect up to three cuboids or frames. Since each cuboid has two connection options, they can be strung together without any problems. As they only have one connection option, the two frames form the end of the chain. The energy-efficient LED lighting in warm white colour is operated with harmless 24 volts.
- Connecting cables with angled plugs are available in two lengths and help to keep the number of cables required as low as possible in numerous setups.
- Shapely and reusable cable holders made of durable silicone help to lay and fix power and connecting cables inconspicuously or to bundle several cables.

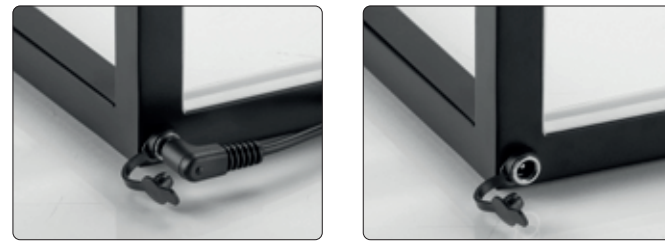

connecting cable "Glow"

black, with angled plugs, for daisy-chaining LED displays items 8400... and -frames items 8405...

item	length
8418.01	1 m
8418.02	2 m



plug for power supply 8416

black, length 2 m, with integrated on/off switch

item	power plug
8416.EU	Europe
8416.UK	UK
8416.US	US

Please note:

This power supply is designed for the simultaneous use of a maximum of 3 LED displays or -frames from the "Glow" series.



power supply for LED displays and -frames "Glow"

black, 60W, 100-240V, for use with plug item 8416. EU/UK/US (please order separately), suitable for LED displays items 8400... and -frames items 8405...

item	length
8416	1.70 m

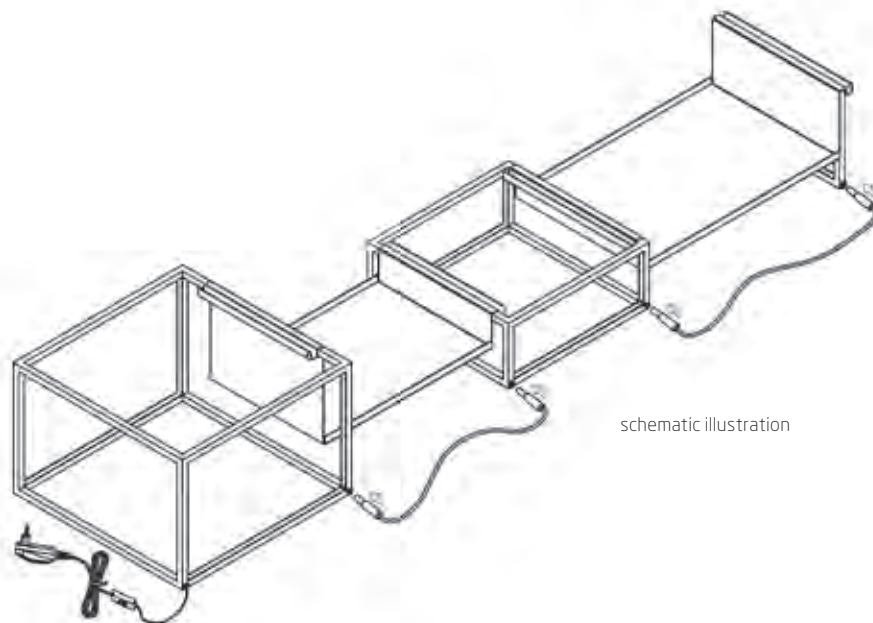

cable holder

silicone, black, length 8 cm, with 3 fastening holes, reusable due to a detachable lock, suitable for guiding cables

item	PU
8412	10 pcs

Please note:

The melamine tray 4581 fits perfectly on the LED display M (item 8400.24) when set up.



base tray "Modul"

melamine, black, surface matt, food-safe, not suitable for microwave and combi steam oven

item	l x w x h in cm	PU
4581	53x28x1.8	2 pcs

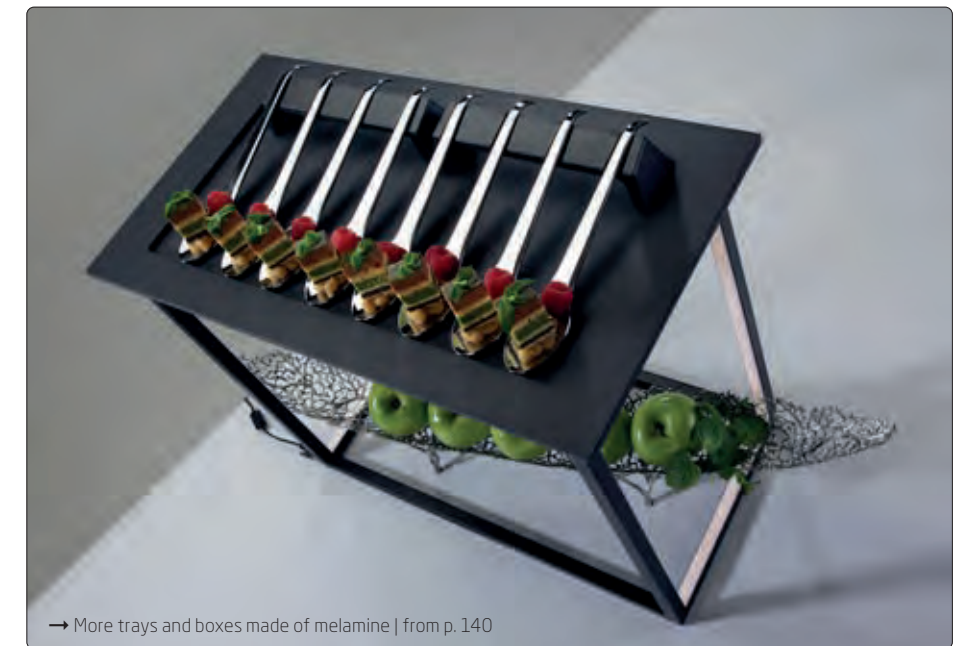



→ “Cuspis” | p. 170



Follow us on YouTube:
Video “Textura”



→ Cooling elements “Chiller Base” | p. 54

“Textura” – indestructible, innovative, exclusive!

The exclusive cuboids consist of thin polyethylene filaments, which are convoluted intricately and fused together, awarding them a flexible and very stable texture. The true potential of this innovative material is disclosed in connection with light. The light-conducting properties of the filigree filaments manifest effectively when using the rechargeable Zieher LED-light (page 53), which fits exactly into the cut-outs on the bottom side of the displays. Buffet platters and trays are reliably kept in position due to the non-slip features of this material. The displays are indestructible and very light, washable and dirt-repellent. The countless interspaces create a light-flooded meshwork, which dries very quickly and is therefore resistant to humidity and mold. Polyethylene can repeatedly be 100% recycled without losing its outstanding characteristics. It is physiologically non-hazardous, odorless, tasteless and resistant to a variety of acids, oils and grease.



i Precisely fitting recess for LED-lights | p. 53

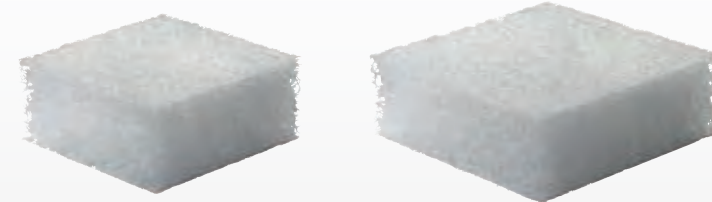

buffet display “Textura”

polyethylene, transparent, with notch for rechargeable LED-light item 8150

item	l x w x h in cm
8232.24	approx. 24x24x10.5
8232.30	approx. 30x30x10.5



Please note:

In order to grant a harmonic all-over illumination while using stacked cuboids, it is recommended to use one LED-light per item. For usage of bigger buffet platters, we suggest to employ the elements with 30 cm edge length. Due to the flexible material, we recommend stacking a maximum of two cubes on top of each other, when the system is equipped with heavy platters or bowls.



The buffet displays and luminaires of the "Somnia" series are assembled from organically shaped, filigree rods which are made of solid brass in traditional sand casting. These single components, reminiscent of brittle branches, are afterwards melded in complex handicraft to impressive unique pieces. Optionally available black rubber caps can be fixed to improve the slip resistance and to protect the sensitive surface of furniture.

The wind light is equipped with a solid base plate with an elevated rim. This base avoids a leakage of wax and protects the table surface from heat. Furthermore it forms the frame for a removable cylinder made of heat resistant glass, which by way of its satined surface, intensifies the mood of light and protects the flame from wind at the same time.



i 2386.10 + 4814.40 + 4685

i 2385.01 + 4814.17

i 2385.02 + 4814.23

i Item 4814.17 is varnished. Therefore we recommend hand washing for this bowl!



candle holder/wind light "Somnia"

brass, golden, matt, not dishwasher-safe, for glass insert item 4991.02 (please order separately) and candles up to Ø 7 cm

item	Ø stand in cm	Ø top in cm	height in cm
2383.01	11	approx. 16.5	approx. 19.5

wind light

borosilicate glass, satined inside, open at the top and the bottom, for candle holder/windlight "Somnia" item 2383.01

item	Ø in cm	height in cm	PU
4991.02	9	14.5	6 pcs

display for bowls "Somnia"

brass, golden, matt, not dishwasher-safe

item	Ø in cm	height in cm	for glass bowl
2385.01	approx. 15.5	approx. 13.5	4814.17
2385.02	approx. 23.5	approx. 22.5	4814.23

buffet display "Somnia"

brass, golden, matt, not dishwasher-safe

item	Ø in cm	height in cm
2386.10	approx. 21.5	approx. 10.5
2386.20	approx. 21.5	approx. 20.5

protecting cap

rubber, black, for buffet display "Somnia" items 2386...

item	Ø in cm	PU
4685	0.4	10 pcs

glass bowl

dark grey, round, handblown, ground edge

item	Ø in cm	height in cm	content in l
4814.17	17	5.5	approx. 0.3
4814.23	23	9.5	approx. 1.5
4814.30	30	13	approx. 3.25
4814.40	40	10	approx. 4.5



→ More grey glass bowls | p. 87-91
 → Buffet bowl 5704 | p. 89

Filigree understatement!

The filigree displays of the "Crossline" series feature enormous stability due to their cleverly elaborated statics. These elements, which have been deliberately designed to have a plain and restrained appearance, unobtrusively blend into every ambience.

The rectangular base has been constructed especially for a presentation bowl made of dark grey glass, which, among other things, impresses by its length of approx. 130 cm. Hinged beams at the upper side of the trestle can be adjusted to the shape of the bowl individually. The supports are felt-covered, which minimises disturbing noise, evens out smaller asperities and provides for slip-resistance.

All trestles are made of galvanised steel and afterwards coated with a robust and scratch-proof matt black powder-coating. Therefore the stands are also suitable for outdoor areas. The variant of raw steel with a rusted and sealed surface inspires by the charm of corroded metal and perfectly matches the industrial style of modern architecture!

Low weight, space-saving storage due to its stackability, easy handling and quick installation are just a few advantages of the "Crossline" series.



→ Buffet platters "Industry 2.0" | p. 59

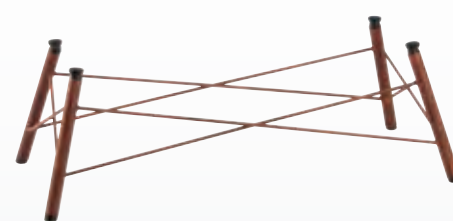

For buffet bowl item 5176 and platters of 80 cm x 40 cm and bigger

buffet stand "Crossline" - rust
 steel, rusted surface, transparent sealing, rectangular, hinged beams on top

item	l x w x h in cm	l x w in cm (on top)
8325.23R	70.5x33.5x23.5	59.5x22



For buffet bowl item 5704 | p. 89 and platters of 42 cm x 42 cm and bigger

buffet stand "Crossline" - rust
 steel, rusted surface, transparent sealing, rectangular, hinged beams on top

item	l x w x h in cm	l x w in cm (on top)
8320.15R	41.5x41.5x15.5	34x34
8320.31R	49.5x49.5x31	34x34



For buffet bowl item 5704 | p. 89 and platters of 42 cm x 42 cm and bigger

buffet stand "Crossline"
 galvanised steel, matt black (powder coating), square, hinged beams on top

item	l x w x h in cm	l x w in cm (on top)
8320.15	41.5x41.5x15.5	34x34
8320.31	49.5x49.5x31	34x34

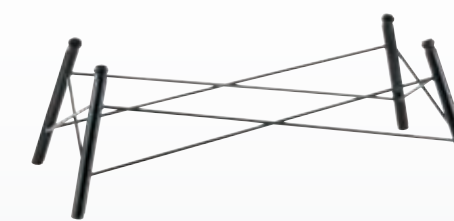

For buffet bowl item 5176 and platters of 80 cm x 40 cm and bigger

buffet stand "Crossline"
 galvanised steel, matt black (powder coating), rectangular, hinged beams on top

item	l x w x h in cm	l x w in cm (on top)
8325.23	70.5x33.5x23.5	59.5x22

Hinged beams at the upper side of the trestle can be adjusted individually to the shape of bowls and platters



buffet bowl
 glass, 8 mm thick, dark grey, oval, structured, delivery in strong wooden box

item	l x w x h in cm
5176	130x42x8



Design: Itamar Harari

Flexibility with a concept

"Curve" is made of 3 mm strong, galvanised steel with a high grade powder coating. This guarantees great stability and corrosion-resistance. The gaps between the bars were expressly chosen to make the raisers completely compatible with the systems "Skyline" (pages 33 to 36) and "Squareline" (pages 37 to 39). "Curve" is therefore not only suitable as a starter version, but also as an optimal extension of existing systems. All components can be stored in an extremely space-saving way. Simple and swift to install, "Curve" is the perfect equipment for outdoor areas, events and catering.



buffet stand "Curve"
galvanised steel, 3 mm thick, matt black (powder-coated), not dishwasher-safe

item	l x w x h in cm	PU
8310.22	27x27x22.5	2 pcs
8310.46	27x27x46.5	2 pcs

Manhattan-Feeling on the Buffet

"Skyline" allows a maximum flexibility for the most exclusive buffet presentations. Different heights enable you to install big buffet platters on the one hand – on the other hand, they can be stabilised by insertion into the corresponding serration. The columns are made of stainless steel and due to the standardised serration heights, they can be combined with the "Squareline" (pages 37 to 39) and "Curve" series (page 32).

LED luminaires make it possible to illuminate the system in combination with light-diffusing tubes (page 52). Different light colours provide great effects.



"Skyline" – the Original!



- different versions: polished and white (golden and copper on request)
- highest Zieher quality and perfect accuracy in manufacturing. Compare the original to copies of inferior quality!

- compatibility with other Zieher systems
- 100 % fitting illumination
- massive stainless steel 18/10
- design by Zieher in 2009



buffet stand "Skyline"
massive stainless steel 18/10, white (powder-coated), square, not dishwasher-safe

item	l x w x h in cm
8305.10	25x25x10.5
8305.22	25x25x22.5
8305.34	25x25x34.5
8305.58	32x32x58.5

buffet stand "Skyline"
massive stainless steel 18/10, highly polished, square, dishwasher-safe, food-safe

item	l x w x h in cm
2177.10	25x25x10.5
2177.22	25x25x22.5
2177.34	25x25x34.5
2177.58	32x32x58.5



→ LED-lights | p. 53

acrylic glass tube
satin (white), removable lid for easy fitting of bowls etc.

item	Ø in cm	height in cm	PU
8122.10	12	10	3 tubes
8122.22	12	22	3 tubes
8122.34	12	34	3 tubes
8122.58	12	58	3 tubes

"Skyline"



Please note:
The bread baskets from the "Skyline" series have a closed base plate and rubber feet. They deviate in height from the buffet stands items 2177... and 8305...



Spot colours upon request!



fruit/bread basket "Skyline"
massive stainless steel 18/10, highly polished, square, with bottom plate and 4 rubber feet

item	l x w x h in cm
2178.23	40x40x23.5



fruit/bread basket "Skyline"
massive stainless steel 18/10, highly polished, square, with bottom plate and 4 rubber feet

item	l x w x h in cm
2179.10	25x25x11.5
2179.34	25x25x35.5

→ Bowl "Sixth Sense" | p. 81



"Skyline"



i Spot colours upon request



transport trolley

aluminium / plywood with ABS-coating, slate-grey, protected against dust and splashwater, lined with rigid foam, incl. stacking cams for safe stacking, 4 heavy duty swivel castors, 2 total brakes, loadable up to 100kg

item	l x w x h (inside) in cm	l x w x h (outside) in cm
566701	114x74.8x60	120x80x80
566702	74x55x54	78x59x66



Due to the same serration heights, the "Skyline" system is combinable with our "Squareline" (p. 38/39) and "Curve" systems (p. 32). The different adaptors of the "Squareline" system may equally be used with the "Skyline" stands (exception: columns with 58 cm height).



"Squareline"



Storage and transportation trolley

We are happy to offer you an individual solution for transportation and storage of your miscellaneous items.

Please ask us!



The buffet system with 1000 faces!

The stainless steel displays of the "Squareline" series are available in two heights and three versions - highly polished, matt black and white coated. They can be stacked easily on top of each other by using different connector pieces. A 90° rotated arrangement of the stands increases the creative leeway tremendously and permits a buffet setup at an angle.

The connector pieces are available in glossy black or satin light-diffusing acrylic. In connection with the various versions of displays and buffet platters, countless possibilities for the creation of a buffet arise.

Optionally, "Squareline" offers the possibility to be illuminated from the inside over the full height. When using the satined connector pieces, their light-diffusing effect even enhances the spectacular sight. "Squareline" is based on the buffet classic "Skyline" (p. 33 to 36), thus a combination of both systems is possible.



The rechargeable LED-light (item 8150, optionally available, page 53) offers numerous fixedly preinstalled colours, as well as special programs like colour gradient and flickering-candle-effect. The compatible remote control (item 8151) allows the synchronisation of up to 20 LED-lights at the same time and enables the change of the complete buffet-colouring by just pressing one button!

Please note: 

To illuminate the system, you will need one LED-light and one acrylic column in the fitting size (12 resp. 24 cm) for each "Squareline" stand. The information on our LED-lights can be found on page 53.



acrylic connector "Squareline"
clear satined (translucent), with 4 stainless steel pins

item	l x w x h in cm
8083.01	27x27x3.5



acrylic glass tube
satined (white), removable lid for easy fitting of bowls etc.

item	Ø in cm	height in cm	PU
8120.01	15	12	3 tubes
8120.02	15	24	3 tubes

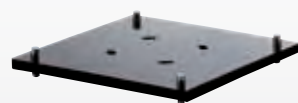

acrylic connector "Squareline"
black, glossy, with 4 stainless steel pins

item	l x w x h in cm
8083.02	27x27x3.5



buffet stand "Squareline"
massive stainless steel 18/10, highly polished, square, dishwasher-safe, food-safe

item	l x w x h in cm
8081.13	24x24x13.5
8081.25	24x24x25.5



buffet stand "Squareline"
massive stainless steel 18/10, white (powder-coated), square, not dishwasher-safe

item	l x w x h in cm
8084.13	24x24x13.5
8084.25	24x24x25.5

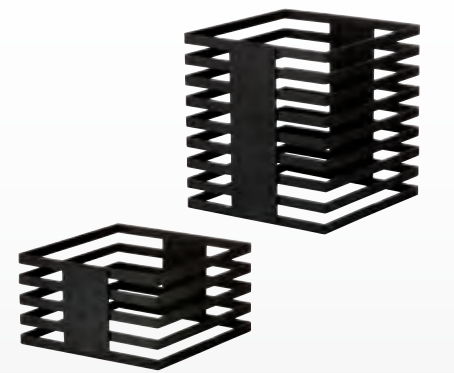

buffet stand "Squareline"
massive stainless steel 18/10, matt black (powder-coated), square, not dishwasher-safe

item	l x w x h in cm
8082.13	24x24x13.5
8082.25	24x24x25.5

→ "Squareline" black + acrylic connector pieces satined, "Lightning Buffet"-tubes | p. 52, rechargeable LED-lights | p. 53



"Solid"



The buffet displays of the "Solid" series are made of solid walnut wood and may be used as containers for cutlery or French bread, but they are particularly suitable for the elevation of the "Modul" base trays (p. 148) or other buffet platters.

The filigree finger joints at the corners testify to precise craftsmanship of the highest quality and guarantee perfect stability!



Please note:

Not dishwasher-safe, do not immerse in water!



buffet display "Solid"

walnut, food-safe sealed, not dishwasher-safe, bottom side open, can be used as a stand or as a container

item	l x w x h in cm	PU
4767.12	12x12x12	2 pcs
4767.24	12x12x24	2 pcs

→ More walnut displays + buffet systems | from p. 122



The "Zieher-System"

Zieher offers innumerable possibilities to present food optically appealing and highly flexible.

The "Zieher-System" with its different heights of 12, 24 and 36 cm or 8, 16, and 24 cm leads to a perfect composition of different presentation levels on the buffet, thus offering more flexibility in its arrangement. A wide range of buffet platters and trays of hardened glass, natural slate and laminated plastic in various styles is available on pages 57 to 63.

Thanks to the boundless possibilities in varying materials and designs, every buffet can easily be adapted to any accommodation. The system becomes part of the whole interior and assimilates harmonically into any ambiance.

"Konkret!"

(from page 46 on)



"Lightning Buffet"

(from page 52 on)

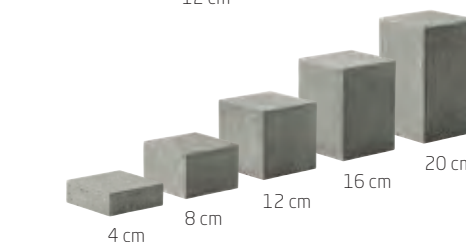
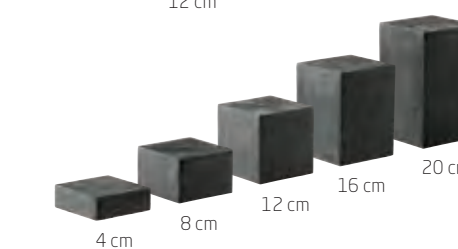

"Classy"

(from page 48 on)

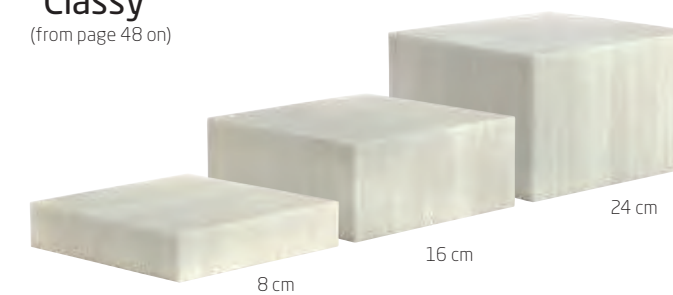

"V12" - Carbon

(from page 44 on)



"Neo"

(from page 50 on)

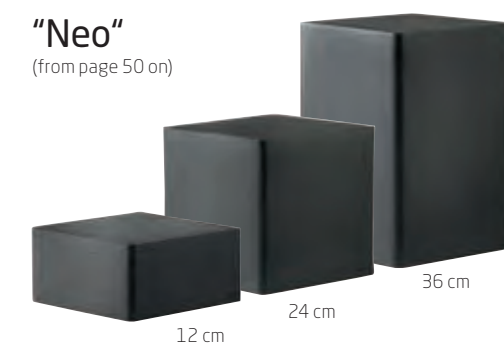

"Solid"

(from page 40 on)



"Luxor"

(from page 42 on)

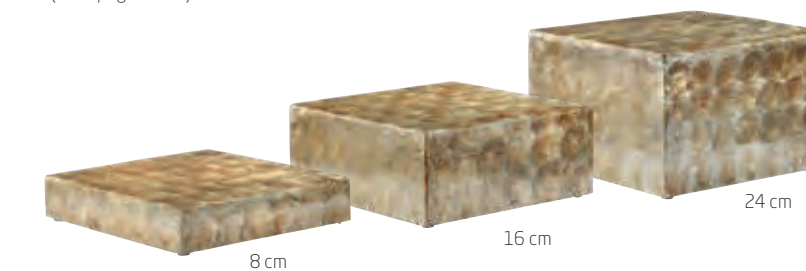



→ Grey glass buffet bowls | p. 88



buffet display "Luxor"

high-quality shell imitation, golden, washable, bottom side open, with 4 resin feet, not dishwasher-safe

item	l x w x h in cm
8221.08	38x38x8
8221.16	38x38x16
8221.24	38x38x24

The shimmering displays of the "Luxor" series enchant by the colour play of golden shades in variable nuances. This effect is created by high-quality shell imitations, which are arranged fan-shaped on a fibreglass base in sophisticated handcrafting. The honed and highly polished, multiple sealing with resin (Polyresin) provides the surface with a striking depth effect.





"V12" combines modern and reduced forms with the precious material carbon. The elegant and three-dimensional look of the carbon fibre paired with maximum stability - "V12" adds high-tech to the buffet!

Three different sizes of the "V12" displays offer a lot of possibilities for the individual composition of your buffet and permit, due to the standardised heights, an easy and simple combination with other Zieher systems. For an overview, please consult page 41.

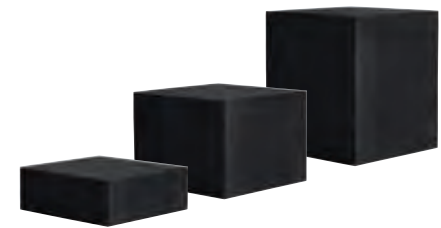

buffet display "V12"

carbon fibre (fabric), high-gloss, black, not dishwasher-safe, splashproof, bottom side closed

item	l x w x h in cm
8206.08	20x20x8
8206.16	20x20x16
8206.24	20x20x24

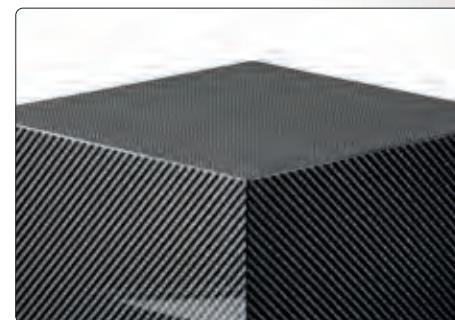



The dark-grey, double-walled XXL bowl inspires by its diameter of 100 cm and creates space for numerous drinks and cooled food. In empty state, it can easily be carried by one person. A filigree, but extremely solid stand made of powder-coated steel forms the perfect basis.

Optionally available rechargeable LED-lights (page 53) allow the illumination of the ice in striking colours. No matter if placed on the buffet table or on the stand – this bowl will leave a permanent impression on your guests!



XXL bowl "Konkret!"

fibreglass/resin, dark grey (concrete look), round, double-walled, not dishwasher-safe, waterproof-coated inside

item	Ø in cm	height in cm
8212.D	100	28



rack for XXL bowls

steel, matt black (powder coating), three-part for self assembly, adjustable feet for firm positioning on most surfaces, for XXL bowl "Konkret!" item 8212.D and XXL glass bowl item 5704

item	l x w x h in cm
8213	70x70x57



hand pump

highly elastic PVC, 2.5 mm thick, with hose, for easy drainage of melt water, professional quality, vacuum capacity: 1.0 l/min

item	Ø hose in cm	total length hose in cm
5662	2	250

→ Rechargeable LED-light 8150 | p. 53



"Konkret!" – distinct design for highest flexibility!

The displays consist of a mixture of fibreglass and stone and therefore offer the deceptively genuine optics of concrete combined with low weight and high stability, which greatly facilitates handling.

Both variants of the displays (light grey and dark grey) are available in eight sizes; a dark grey XXL bowl impresses with huge size paired with light weight.



buffet display "Konkret!"

fibreglass/resin, light grey (concrete look), not dishwasher-safe, splash-proof, hollow inside, bottom side open

item	l x w x h in cm	PU
8200.12L	24x24x12	2 pcs
8200.24L	24x24x24	2 pcs
8200.36L	24x24x36	2 pcs

buffet display "Konkret!"

fibreglass/resin, light grey (concrete look), not dishwasher-safe, splash-proof, hollow inside, bottom side open

item	l x w x h in cm	PU
8210.04L	12x12x4	2 pcs
8210.08L	12x12x8	2 pcs
8210.12L	12x12x12	2 pcs
8210.16L	12x12x16	2 pcs
8210.20L	12x12x20	2 pcs

buffet display "Konkret!"

fibreglass/resin, dark grey (concrete look), not dishwasher-safe, splash-proof, hollow inside, bottom side open

item	l x w x h in cm	PU
8200.12D	24x24x12	2 pcs
8200.24D	24x24x24	2 pcs
8200.36D	24x24x36	2 pcs

buffet display "Konkret!"

fibreglass/resin, dark grey (concrete look), not dishwasher-safe, splash-proof, hollow inside, bottom side open

item	l x w x h in cm	PU
8210.04D	12x12x4	2 pcs
8210.08D	12x12x8	2 pcs
8210.12D	12x12x12	2 pcs
8210.16D	12x12x16	2 pcs
8210.20D	12x12x20	2 pcs

The buffet displays "Classy" are made of translucent material and impress by their noble texture, which is reminiscent of Italian marble or alabaster.

"Classy" is available in the Zieher system heights of 8, 16 and 24 cm and can therefore be combined in various ways. The open bottom side of the large displays allows an effective illumination by the optionally available LED-lights (page 53).

The small cube has no open underside and thus cannot be illuminated. The advantage of this construction lies in its high functionality. Its dimensions of 24 cm x 16 cm x 8 cm enable a positioning in 3 heights - a useful supplement to the squarish displays.



→ Baskets "Reef" | from p. 70

i Closed on all sides, cannot be illuminated



buffet display "Classy"

resin, white, alabaster look, not dishwasher-safe, closed on all sides, can be used in any position

item	l x w x h in cm
8231	24x16x8



buffet display "Classy"

resin, white, translucent, alabaster look, not dishwasher-safe, bottom side open, notch for cable on back side

item	l x w x h in cm
8230.08	38x38x8
8230.16	38x38x16
8230.24	38x38x24

i Notch for cable for wired LED-lights





Cable notch for LED-light



buffet display/ice bucket "Neo"
resin, anthracite, matt, translucent, not dishwasher-safe, open underside, with notch for cable on the back. Can be used on both sides!

item	l x w x h in cm
7005.16	53x32.5x16

Please note:  Isolated air inclusions in the material as well as slight colour deviations cannot be avoided due to production technology.



buffet display "Neo"
resin, anthracite, matt finish, translucent, not dishwasher-safe, bottom side open, notch for cable on back side

item	l x w x h in cm
7002.12	24x24x12
7002.24	24x24x24
7002.36	24x24x36



The buffet system "Neo" is made of anthracite coloured resin. The matt surfaces and softly rounded edges of these translucent cuboids appear unobtrusive and modern. The optionally available LED-lights (pages 53) are the ideal completion to put "Neo" into its true light. Thanks to the battery-operated LED-lights, which are waterproof to a depth of one metre and can be remote-controlled, even the ice in the ice containers can be illuminated from below. The large selection of different light colours enables spectacular effects!



"Lightning Buffet"



Bringing light into the darkness!

The illuminated buffet stands, in connection with platters made of natural slate, laminated plastic or glass (from page 57), make every buffet shine in a radiant new light. The innovative LED technology does not emit any heat and is powered by a harmless voltage. It is characterised by its longevity and its low power consumption.



acrylic glass tube

satined (white), removable lid for easy fitting of bowls etc.

item	Ø in cm	height in cm	PU
8122.10	12	10	3 tubes
8122.22	12	22	3 tubes
8122.34	12	34	3 tubes
8122.58	12	58	3 tubes

acrylic glass tube

satined (white), removable lid for easy fitting of bowls etc.

item	Ø in cm	height in cm	PU
8120.01	15	12	3 tubes
8120.02	15	24	3 tubes
8120.03	15	36	3 tubes

The height of the columns items 8122... has been adjusted especially for the illumination of the "Skyline" buffet system. The lids of all acrylic glass tubes are removable. Therefore the tubes can also function as supports for plates, bowls, etc.



Rechargeable LED-light with radio remote control:

The compact LED-light is controlled by remote control, which allows for a more flexible use of the Zieher "Lightning Buffet" and renders it independent from any power supply and spatial requirement!

This creates a lot of new possibilities for the buffet setup: out in the open, next to the pool or in the middle of the room - without any troublesome cables and controllers that might get into the guests' or the personnel's way. The radio remote control item 8151 (to be ordered separately) rounds off the whole system in regard to function and handling and allows to choose the colouring within a range of up to 15 m without dismantling the buffet first. Due to many different colours and special programs, the buffet will fit into every kind of atmosphere. The lighting colour for the complete buffet can be changed by pressing only one button.



The luminosity depends on the spatial realities; the actual colouring may deviate from the colours shown in the pictures!



The entire instruction sheet with a detailed description of all functions is available at https://www.zieher.com/fileadmin/ZieherUploads/Bedienungsanleitungen/Bedienungsanleitung_Akku_LED_Leuchte__8150_.pdf



remote control

for rechargeable LED-light item 8150, white with grey cord

item	l x w x h in cm
8151	8.5x5.2x2.8



charging device for rechargeable LED-light

white, with handy cable spool (1.5 m of cable), wall fixing possible, 3 anti-slip rubberfeet, Ø 13 cm, 2 cm high

item	power plug
8152.EU	Europe
8152.UK	UK
8152.US	USA



rechargeable LED-light

remote-controlled, 3 different degrees of brightness (only selectable on the light directly), 7 fixed colours (white, green, red, blue, yellow, violet, turquoise) and additionally: candle flickering, colour gradient and colour change (only selectable by remote control item 8151, please order separately)

item	Ø in cm	height in cm
8150	9.5	3



- 7 fixed colours and 3 special programs, manageable via remote control (white, green, red, blue, yellow, violet, turquoise, flickering-candle-effect, colour change, colour gradient)
- 3 different brightness-settings selectable (100% - 70% - 50%, only adjustable directly)
- Fixedly integrated high-performance batteries guarantee a running-time of up to 20 hrs (at the lowest brightness-setting)
- LED-light waterproof up to a depth of 1 m
- Remote control (to be ordered separately) controls up to 20 LED-lights simultaneously / range up to 15 m
- Charging device can be mounted on a wall and features a space-saving cable spool



brightness-setting at the light

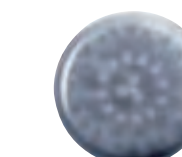

100%

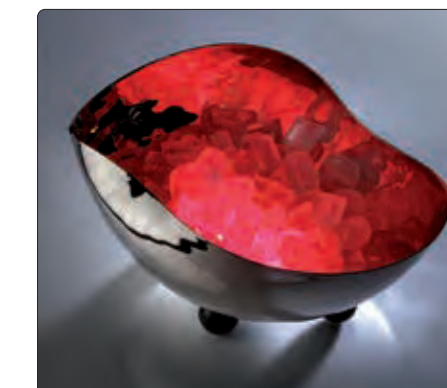

Waterproof up to a depth of 1 metre



→ Porcelain bowl “Cave” | p. 184

Cooling pillows

The cooling pads have been tailor-made for the melamine base to provide for an optimal cooling surface by the perfect fit. The pads can optionally be flipped, depending on whether the black top or the white bottom fits into the overall picture more harmoniously. This way, they are applicable inconspicuously, even with slightly translucent or satined buffet platters.

The attractive contrast of top and bottom can also be used on the laid table to deliberately set accents. Serving chilled food becomes a visual highlight. The high-quality case made of black or white nylon fabric looks very noble and yet discreet. It is filled with gel, which remains malleable, even when frozen and thus allows an adaptation to a wide variety of tableware used.



cooling pack
nylon, black/white, non-toxic cooling gel

item	l x w in cm
5663.20	20x20

→ Buffet platters made of glass in the formats 42 cm x 42 cm and 50 cm x 50 cm | from p. 57



chiller base/tray
melamine, square, for cooling pack item 5663.20

item	colour	l x w x h in cm
4597.01	black	41x41x3.5
4597.02	white	41x41x3.5



→ “Textura” buffet displays | p. 26/27

“Chiller-Base” – just stay cool!

The cooling elements are an elegant and simple solution for a quick and flexible installation of chilled platters. They can be arranged either at different heights by using displays or freely positioned on the buffet table.

The flat bowls are available in matt black and white melamine and have been designed specifically for food whose presentation can be extended significantly by cooling.

The puristic form, the compact height of only 35 mm as well as the restrained colouring allow a stylishly discreet integration into numerous buffet constructions. Tailored recesses on the underside of the trays facilitate symmetrical positioning on most Zieher buffet systems. Unobtrusive rubber buffers in the corners of the “Chiller-Base” ensure a non-slip and secure fit of laid-up platters in sizes starting from 42 x 42 cm (page 57-63).



“Skyline” | p. 33-36 “Skyline” | p. 33-36 “Squareline” | p. 37-38 “Konkret!” | p. 46-47

Please note:

Cleaning the cooling tray “Chiller-Base” (4597..) in the dishwasher is possible up to a maximum water temperature of 70 degrees.



Buffet platters and more!

Zieher is offering a wide range of buffet platters made of laminated plastic, glass and natural slate. Due to the wide choice of formats and types of materials, there are many possibilities of combinations with Zieher's buffet systems (pages 8 to 55).

The offer is being completed by various buffet stairs, trays and bowls (from page 64).

Buffetplatters made of structured glass

- Special hardened safety glass, 6 mm thick
- Rounded edges
- Bottom structured
- Uneven design
- Dishwasher-safe

NEW



Structured glass | page 57

- Special hardened safety glass
- 6 mm thick
- Rounded edges
- Bottom structured
- Uneven design
- Dishwasher-safe

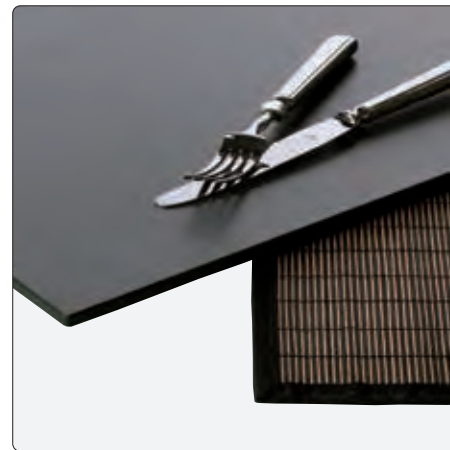

Laminated plastic | page 58

- Dark grey resp. black, black intermediate ply
- 8 mm thick
- Break-proof
- Dishwasher-safe
- Scratch-proof
- Antistatic



Laminated plastic | page 59

- Rusted look, black intermediate ply
- 8 mm thick
- Break-proof
- Dishwasher-safe
- Scratch-proof
- Antistatic

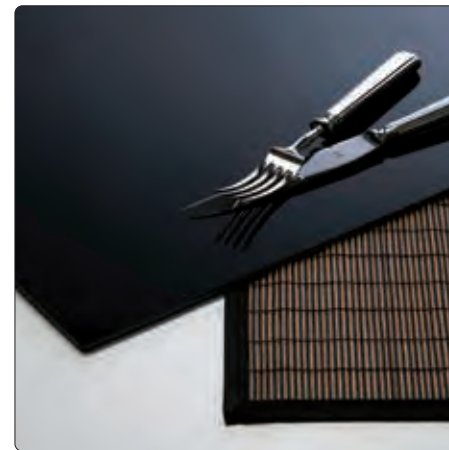

Black glass | page 60

- Specially hardened safety glass
- 4 mm thick, low weight
- Edges polished and rounded
- Underside scratch-resistant, black
- Shock-proof, heat-resistant
- Dishwasher-safe



→ series "Ombra" | p.158

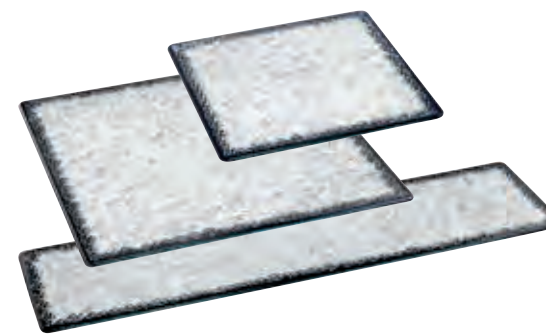

buffet platter "Ombra"

glass, 6 mm thick, clear, black decor, structured, dishwasher-safe

item	version	l x w in cm
5114.01	square	50x50
5114.02	rectangular	50x42
5114.04	square	42x42
5114.06	square	34x34
5114.08	rectangular	80x21



White glass | page 61

- Specially hardened safety glass
- 4 mm thick, low weight
- Edges rounded and polished
- Underside scratch-resistant, white
- Shock-proof, heat-resistant
- Dishwasher-safe

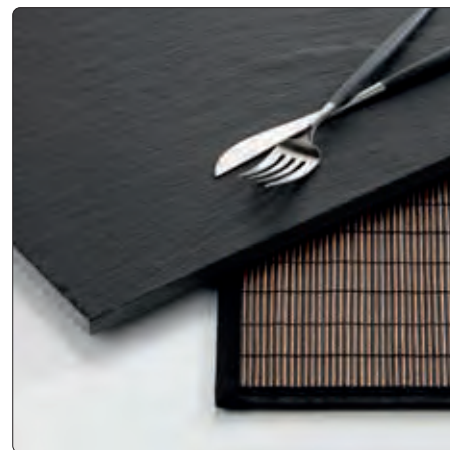

Natural slate | page 62

- Food-safe sealed/unsealed
- 10-15 mm thick
- With rubber feet

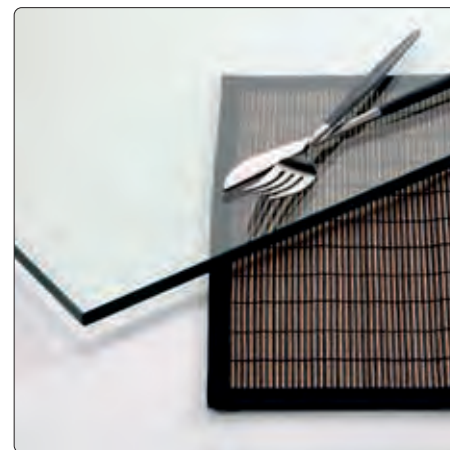

Transparent glass | page 63

- Specially hardened safety glass
- 10 mm thick
- Edges polished and deburred
- Dishwasher-safe

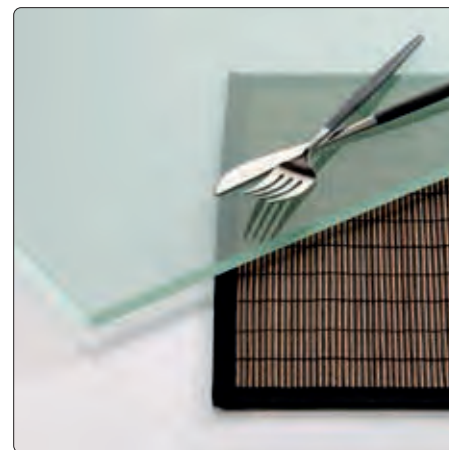

Satined glass | page 63

- Specially hardened safety glass
- 10 mm thick
- Edges polished and deburred
- Underside satined
- Dishwasher-safe



→ "Époques" | p.12-15

Buffet platters made of laminated plastic

- Dark grey resp. black, black intermediate ply
- 8 mm thick
- Break-proof
- Dishwasher-safe
- Scratch-proof, antistatic



Buffet platters made of laminated plastic

- Rusted look, black intermediate ply
- 8 mm thick
- Break-proof
- Dishwasher-safe
- Scratch-proof, antistatic



The buffet platters made of laminated plastic are available in two neutral versions as well as in an extraordinary version. They are break-proof, scratch-resistant, antistatic and dishwasher-safe and impress with these excellent properties and the resulting advantages. All laminated buffet platters by Zieher have a dark middle layer and can be used on both sides because of their double-coating.

Please note:



With this decor, each plate is unique - none of them look alike.

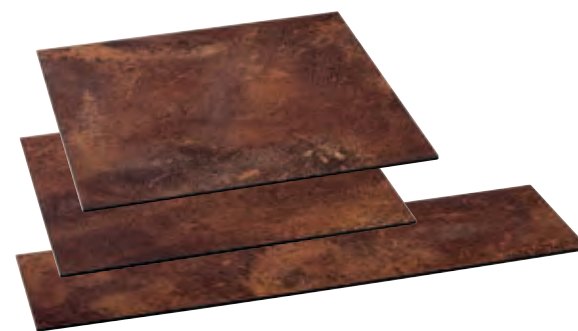
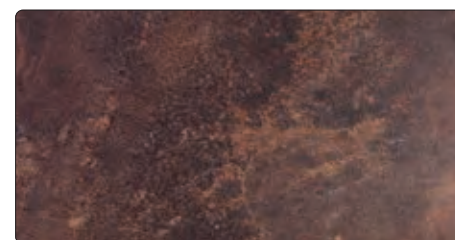

→ Buffet display "Crossline" | p. 30

Please note:



The black buffet platters 8010... are sized to fit the LED displays "Glow" (from page 20).

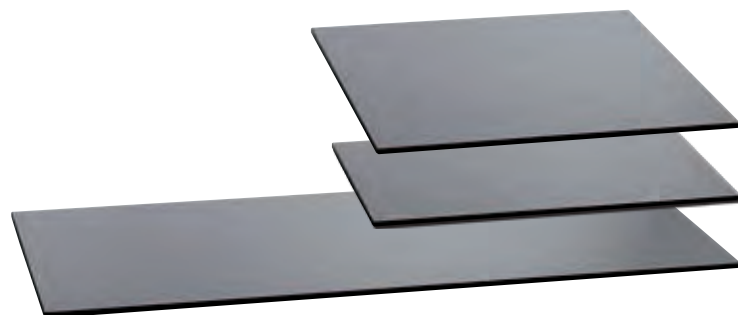

buffet platter, laminated plastic

laminated plastic, 8 mm thick, black, black intermediate ply, break-proof, scratch-proof, dishwasher-safe, antistatic, deburred edges, rounded corners

item	version	l x w in cm
8010.01	rectangular	41x17
8010.02	rectangular	49x25
8010.03	rectangular	49x33

buffet platter, laminated plastic

laminated plastic, 8 mm thick, dark grey, black intermediate ply, break-proof, scratch-proof, dishwasher-safe, antistatic, deburred edges, rounded corners

item	version	l x w in cm
8006.01	square	50x50
8006.02	rectangular	50x42
8006.04	square	42x42
8006.06	square	34x34
8006.08	rectangular	80x21
8006.11	1/1 GN	53x32.5
8006.13	rectangular	95.4x39
8006.14	rectangular	91x21
8006.15	rectangular	102x21

buffet platter "Industry 2.0"

laminated plastic, 8 mm thick, rusted look, black intermediate ply, break-proof, scratch-proof, dishwasher-safe, antistatic, deburred edges, rounded corners

item	version	l x w in cm
8007.01	square	50x50
8007.02	rectangular	50x42
8007.04	square	42x42
8007.06	square	34x34
8007.08	rectangular	80x21
8007.11	1/1 GN	53x32.5
8007.13	rectangular	95.4x39

Buffet platters made of black glass

- Specially hardened safety glass
- 4 mm thick, low weight
- Edges rounded and polished
- Underside scratch-resistant, black
- Shockproof, heat-resistant, dishwasher-safe



Buffet platters made of white glass

- Specially hardened safety glass
- 4 mm thick, low weight
- Edges rounded and polished
- Underside scratch-resistant, white
- Shock-proof, heat-resistant, dishwasher-safe



→ Buffet system "Konkret!" | p. 47



buffet platter, black glass

special hardened safety glass, 4 mm thick, black, rounded edges, polished rim, dishwasher-safe, rubber feet included (adhesive), underside scratch-proof

item	version	l x w in cm
1668.01	square	50x50
1668.03	rectangular	50x34
1668.04	square	42x42
1668.05	rectangular	42x34
1668.06	square	34x34
1668.08	rectangular	80x21
1668.22	rectangular	91x21
1668.24	rectangular	102x21



charger plate, black glass

special hardened safety glass, 4 mm thick, black, round, edge polished, dishwasher-safe, rubber feet included (adhesive), underside scratch-proof

item	Ø in cm
1669.33	33

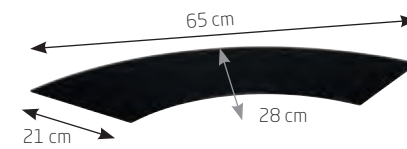

buffet platter Curve 90°

special hardened safety glass, 4 mm thick, black, curved shape, rounded edges, polished rim, dishwasher-safe, rubber feet included (adhesive), underside scratch-proof

item	l x w in cm	PU
1668.15	65x28	2 pcs



buffet platter, black glass

special hardened safety glass, 4 mm thick, black, with 2 concave cutouts, rounded edges, polished rim, dishwasher-safe, rubber feet included (adhesive), underside scratch-proof

item	l x w in cm
1668.20	49x21



buffet platter, white glass

special hardened safety glass, 4 mm thick, white, rounded edges, polished rim, dishwasher-safe, rubber feet included (adhesive), underside scratch-proof

item	version	l x w in cm
1670.01	square	50x50
1670.04	square	42x42
1670.09	rectangular	80x40
1670.10	rectangular	30x18
1670.12	rectangular	66x10



buffet platter, white glass

special hardened safety glass, 4 mm thick, white, round, edges polished, dishwasher-safe, with rubber feet (adhesive), underside scratch-proof

item	Ø in cm
1671.33	33
1671.53	53



buffet platter, white glass

special hardened safety glass, 4 mm thick, white, with 2 concave cutouts, rounded edges, polished rim, dishwasher-safe, rubber feet included (adhesive), underside scratch-proof

item	l x w in cm
1670.20	49x21

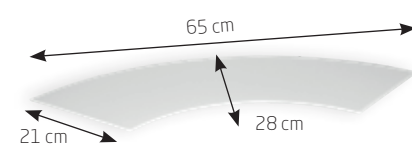

buffet platter Curve 90°

special hardened safety glass, 4 mm thick, white, curved shape, rounded edges, polished rim, dishwasher-safe, rubber feet included (adhesive), underside scratch-proof

item	l x w in cm	PU
1670.15	65x28	2 pcs

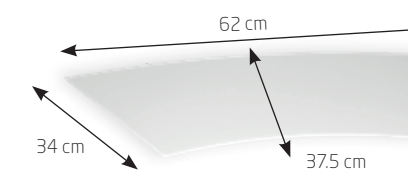

buffet platter Curve 45°

special hardened safety glass, 4 mm thick, white, curved shape, rounded edges, polished rim, dishwasher-safe, rubber feet included (adhesive), underside scratch-proof

item	l x w in cm	PU
1670.14	62x37.5	2 pcs



→ Miniatures made of glass | from p. 236

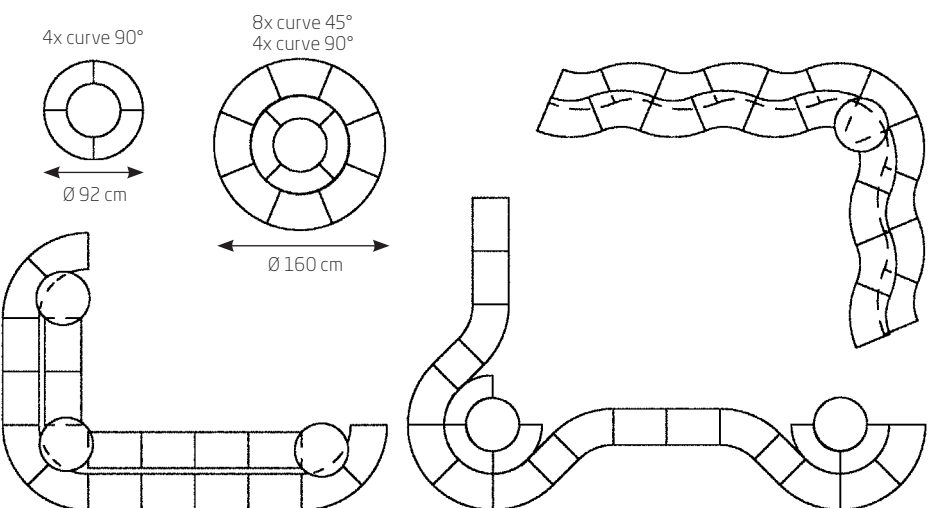

The curved platters combined with compatible buffet platters and buffet stands allow innumerable variations!

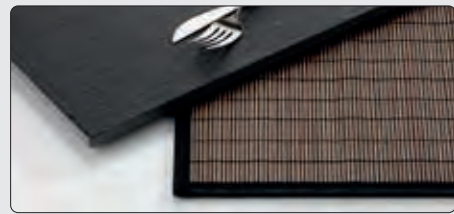

Buffet platters made of slate!

- Natural slate
- Food-safe sealed/unsealed
- 10 to 15 mm thick / dinner plate approx. 5 mm thick
- With rubber feet



Buffet platters made of transparent glass

- Specially hardened safety glass
- 10 mm thick
- Edges polished and deburred
- Dishwasher-safe



Please note:

Slate is a unique and exceptional natural product. The surfaces of our slate plates have the typical cleavage, which makes every piece a unique product. Small deviations in structure, thickness (10 to 15 mm) and weight of the platters is in the nature of the product and part of its precious and vivid appearance.

Specific groceries, especially those that contain fruit acid (citric acid) may damage the surface in case of prolonged contact. Therefore we recommend avoiding any direct contact with edibles.

The charger plates are not sealed. To achieve an evenly dark grey colouring, we recommend rubbing the platter with vegetable oil from time to time.



buffet platter, slate

natural slate, 10 to 15 mm thick, food-safe (sealed), not dishwasher-safe, with rubber feet

item	version	l x w in cm
8005.01	square	50x50
8005.04	square	42x42



buffet platter, slate

natural slate, 10 to 15 mm thick, food-safe (sealed), not dishwasher-safe, round, with rubber feet

item	Ø in cm
8005.21	60



charger plate, slate

natural slate, approx. 5 mm thick, unsealed, not dishwasher-safe, with rubber feet

item	version	l x w in cm
2543.30	square	30x30
2544.30	rectangular	30x20

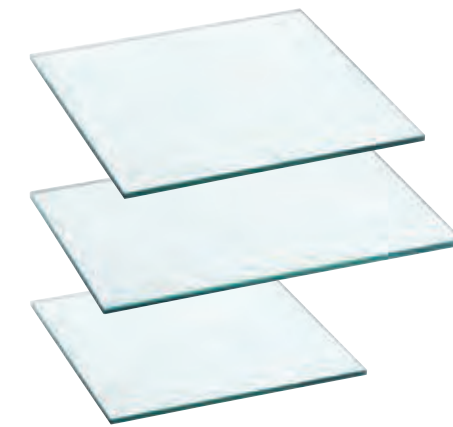

buffet platter, clear glass

hardened glass, 10 mm thick, edges polished and deburred

item	version	l x w in cm
8004.01	square	50x50
8004.02	rectangular	50x42
8004.03	rectangular	50x34
8004.04	square	42x42
8004.05	rectangular	42x34
8004.06	square	34x34
5243	rectangular	80x21
5000	rectangular	95,4x39



→ Tray stand "Solid" | p. 20



charger plate/glass insert

clear glass, 6 mm thick, round, edge polished and deburred

item	Ø in cm
4999	33

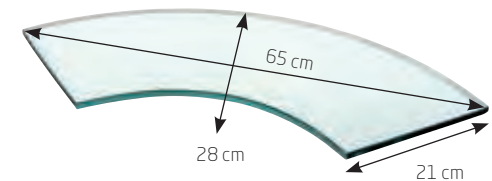

buffet platter Curve 90°

hardened clear glass, 10 mm thick, curved shape, edges polished and deburred

item	l x w in cm	PU
5241	65x28	2 pcs

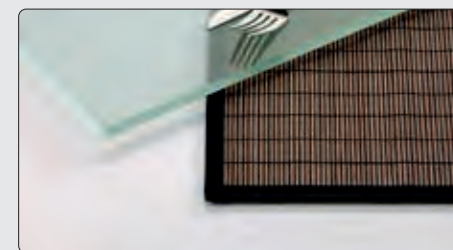

Buffet platters made of satined glass

- Specially hardened safety glass
- 10 mm thick
- Edges polished and deburred
- Underside satined
- Dishwasher-safe

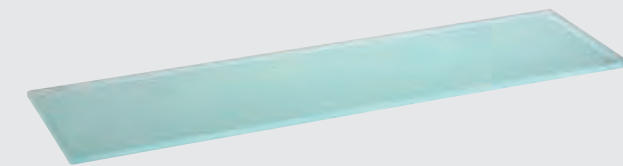

buffet platter, satined glass

hardened glass, 10 mm thick, satined, edges polished and deburred

item	version	l x w in cm
5243.M	rectangular	80x21



glass tray
glass, dark grey, rectangular

item	l x w x h in cm
5161.31	31x21x3.5
5161.62	62x21x3.5



glass tray
glass, satined, rectangular

item	l x w x h in cm
5160.31	31x21x3.5
5160.62	62x21x3.5



→ Buffet system "Skyline" | p. 34

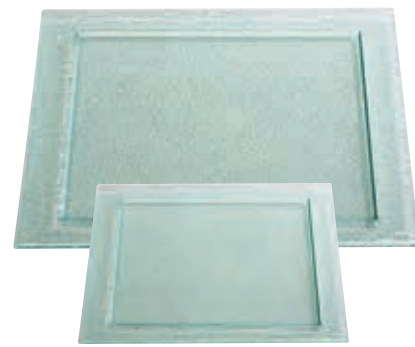

glass platter
glass, structured, transparent, square

item	l x w in cm
5063	30x30
5063.50	50x50



glass steps
wavy, 7 steps, delivered in a wooden box,
horizontal length: 67 cm/vertical length: 65 cm

item	version	width in cm
5076.01	clear	40



glass steps
56 cm long, 42 cm wide (horizontal position)

item	l x w x h in cm (glass step)	thickness in mm
5026.02	51x42x23	8



glass tray
deep black, usable for buffet, flying buffet or as a tray

item	l x w x h in cm	version
5142.34	35x35x2	square
5141.50	51x35x2	rectangular



glass steps
5026.03: 33 cm long, 34 cm wide (horizontal position)
5026.04: 56 cm long, 42 cm wide (horizontal position)

item	l x w x h in cm (glass step)	thickness in mm
5026.03	31x34x12	6
5026.04	51x42x23	8

Please note:

The glass steps items 5026... are adjusted to the Zieher system and due to their height of 12 resp. 24 cm, can easily be combined with many Zieher buffet raisers (page 41). All large steps are supplied in a sturdy wooden box!



VENTA by Büchin Design has developed an elegant buffet furniture programme for the high demands of the hotel industry and for exclusive events. It is equipped with a number of technical features to keep food hot or cold.

The tables are equipped with castors and can therefore be used very flexible in different rooms. They can be stowed under each other or dismantled and stored in trolleys in just a few simple steps.



The modular buffet table system STAGE can be assembled and disassembled in just a few easy steps, without the need for any tools.



All four tables fit into one trolley. The individual parts are safely stored, each part has its own place.

MODULAR BUFFET SYSTEM

- Adjustable heights
- Movable castors
- Nesting storage
- Trolley Transport System

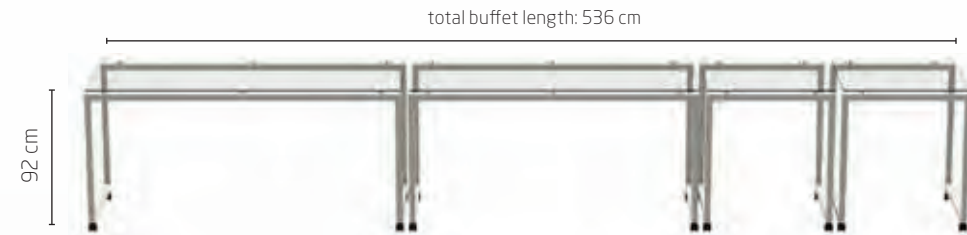

all tables in a row / adjusted at the same height



Zieher and VENTA cooperate in the area of buffet presentation. The Zieher table-top buffet elements harmonise excellently with the modular buffet system "STAGE" of the VENTA brand.

All details of VENTA system you will find at: www.ventadesign.com



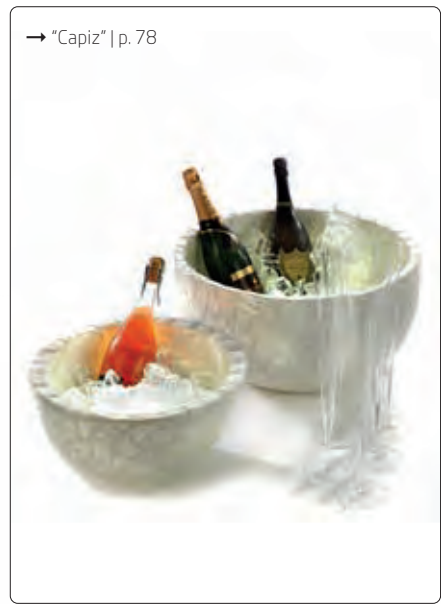
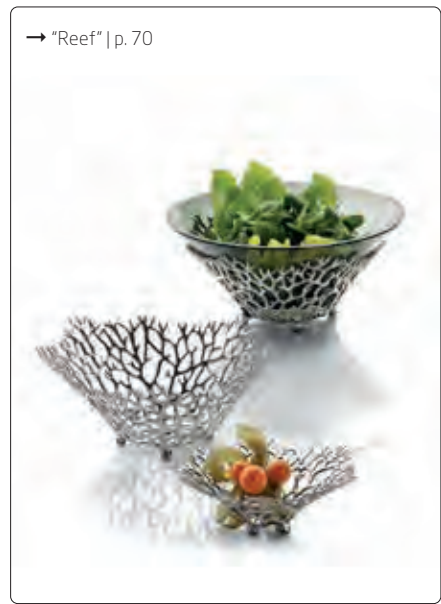

Buffet bowls

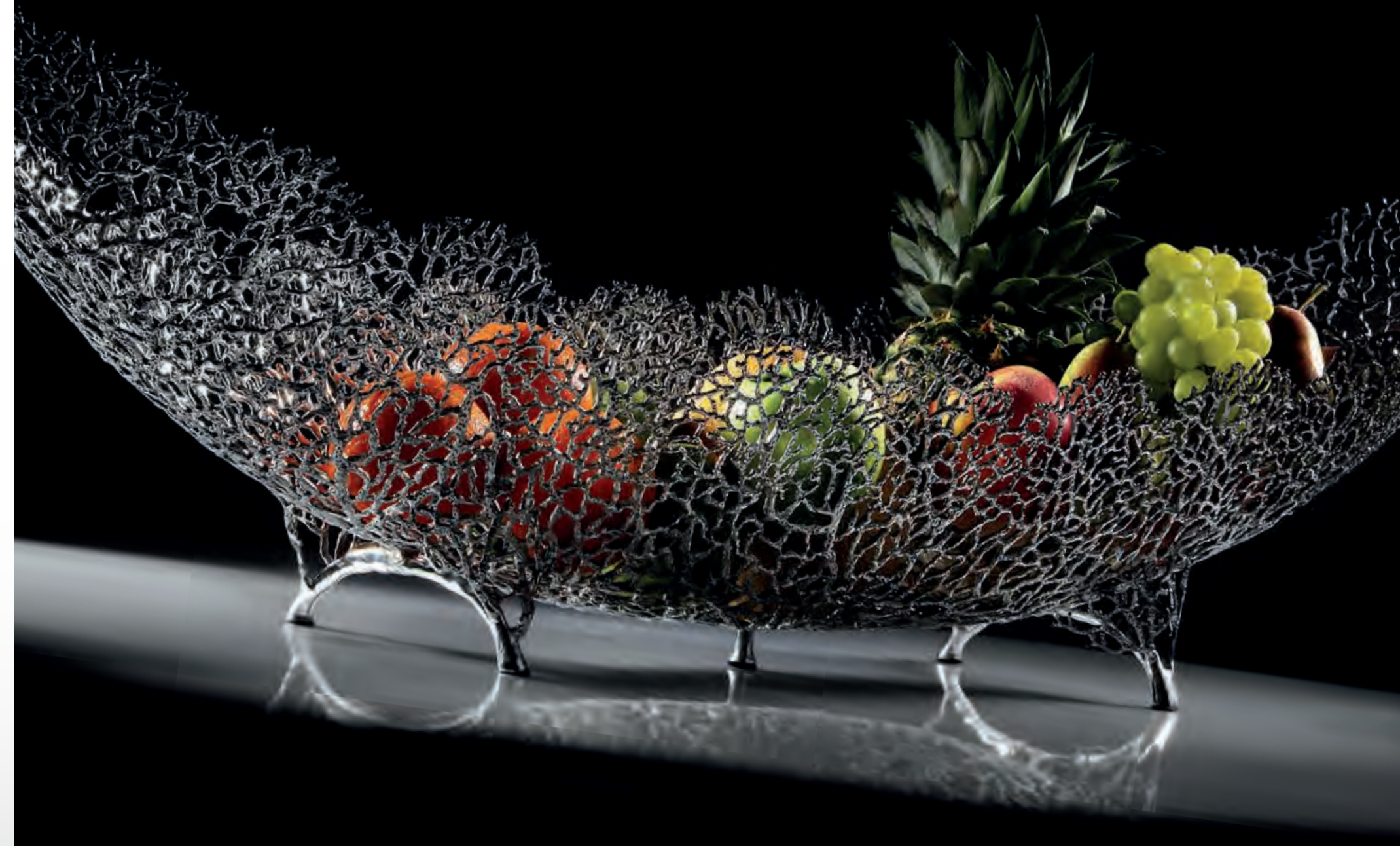

"Reef"

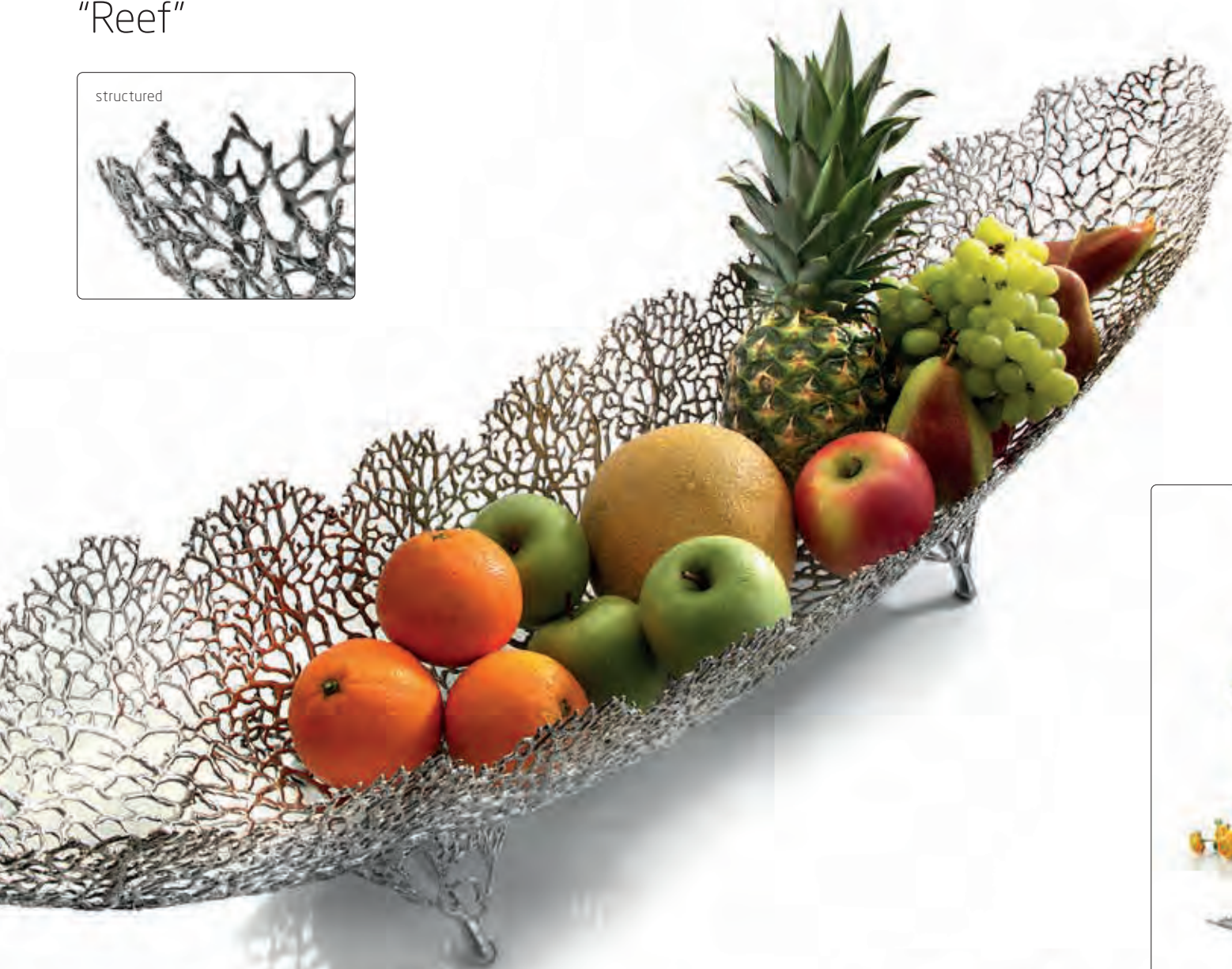
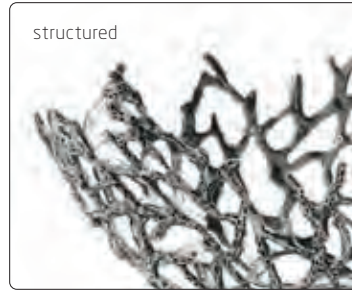

bowl/basket "Reef"

pewter, structured and patinated outside, food-safe, not dishwasher-safe, with supporting feet

item	l x w x h in cm
2337	100x24x30

bowl/basket "Reef"

pewter, structured and patinated outside, oval, food-safe, not dishwasher-safe

item	l x w x h in cm
2332	20x10x12



bowl/basket "Reef"

pewter, structured and patinated outside, food-safe, not dishwasher-safe, with supporting feet

item	w x d x h in cm
2335	54x18x66



bowl/basket "Reef"

pewter, structured and patinated outside, food-safe, not dishwasher-safe, with supporting feet

item	l x w x h in cm
2336	75x10x14



bowl/basket "Reef"

pewter, surface smooth, food-safe, not dishwasher-safe, with feet

item	l x w x h in cm
2314.02	approx. 21x12.5x33
2314.03	approx. 37x18.5x52



bowl/basket "Reef"

pewter, smooth outside, oval, food-safe, not dishwasher-safe

item	l x w x h in cm
2313.01	46x19x20
2313.02	32x13x13



candle holder/wind light "Reef"

pewter, surface smooth, food-safe, not dishwasher-safe, with feet, for glass insert item 4991.02 and candles up to Ø 7 cm

item	Ø in cm	height in cm
2315.01	10	15.5



Large numbers of single parts are cast from premium pewter and assembled in high-grade craftsmanship to give shape to these items. The inimitable pieces of art created that way are unique items, which inspire by the polished surface of the organic structures and the rounded tails of the meshwork. The products of the "Reef" series are genuine gems of dining culture.

The outside texture of the bowls differs within the series: whether smoothly rounded or roughly structured with dark, patinated deepenings – each variant has its own charm.

Follow us on YouTube:
Video "Reef"



wind light

borosilicate glass, satined inside, open at the top and the bottom, for wind light "Reef" item 2315.01

item	Ø in cm	height in cm	PU
4991.02	9	14.5	6 pcs



"Reef"

Showpieces of table culture – “Reef”



i Item 4814.17 is varnished. Therefore we recommend hand washing for this bowl!



glass bowl

dark grey, round, handblown, ground edge, suitable for bowl/basket “Reef” items 2320 and 2322

item	Ø / height in cm	content in l	suitable to
4814.17	17/5.5	0.3	item 2320
4814.23	23/9.5	1.5	item 2322
4814.30	30/13	3.25	item 2322



bowl/basket “Reef”

pewter, smooth outside, round, food-safe, not dishwasher-safe, with supporting feet, for glass bowl item 4814.17 and 4814.23/30 (please order separately)

item	Ø in cm	height in cm	suitable to
2320	16	5.5	item 4814.17
2322	22	9.5	item 4814.23/30

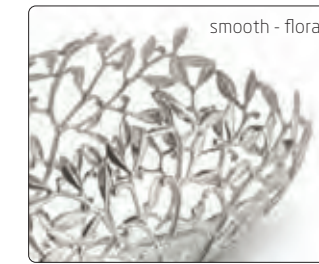

“Reef” in a new form – “Leaf”

With the new “Leaf” decor, the artful “Reef” bowls and baskets made from high-quality pewter alloy take on a lively and floral touch.

The delicate tendrils and intricate leaves give off a playful vibe and convey a completely different charm despite their resemblance to the fossil-inspired designs of the “Reef” series.

Proven craftsmanship reinterpreted!



bowl/basket “Leaf”

pewter, smooth outside, oval, food-safe, not dishwasher-safe

item	l x w in cm	height in cm
2353.02	32x13	13



“Leaf” **NEW**



bowl/basket “Reef”

pewter, smooth outside, round, flat, food-safe, not dishwasher-safe

item	Ø in cm	height in cm
2311	22	5



glass bowl

glass, 6 mm thick, dark grey, organically shaped, for bowl/basket “Reef” item 2310 (please order separately)

item	Ø / height in cm	content in l	PU
5166	13/6.5	approx. 0.3	2 pcs



small glass bowl

borosilicate glass, handblown, round

item	Ø / height in cm	content in l	PU
4930	7/5	approx. 0.14	24 pcs



small glass bowl

borosilicate glass, handblown, round

item	Ø / height in cm	content in l	PU
4930	7/5	approx. 0.14	24 pcs



glass bowl

glass, 6 mm thick, dark grey, organically shaped, for bowl/basket “Leaf” item 2350 (please order separately)

item	Ø / height in cm	content in l	PU
5166	13/6.5	approx. 0.3	2 pcs



i

Please note:

Since medieval times, pewter has been used primarily for table top items and has been the most important raw material for a very long time. The popularity of pewter first started decreasing in the 18th and 19th century by the progressing development of glass and the increasing popularity of porcelain. Since then the usage of pewter has shifted mainly to decorative elements. Up-to-date pewter is 100 % lead-free and therefore uncritical when used for food.



bowl/basket “Reef”

pewter, smooth outside, round, food-safe, not dishwasher-safe, with supporting feet, for small glass bowl item 5166 (please order separately)

item	Ø in cm	height in cm
2310	13	8



bowl/basket “Reef”

pewter, smooth outside, round, food-safe, not dishwasher-safe, with supporting feet, for small glass bowl item 4930 (please order separately)

item	Ø / height in cm	PU
2318	8/5	2 pcs



small bowl/basket “Leaf”

pewter, smooth outside, round, food-safe, not dishwasher-safe, with supporting feet, for small glass bowl item 4930 (please order separately)

item	Ø / height in cm	PU
2358	8/5	2 pcs



bowl/basket “Leaf”

pewter, smooth outside, round, food-safe, not dishwasher-safe, with supporting feet, for small glass bowl item 5166 (please order separately)

item	Ø in cm	height in cm
2350	13	8



Dynamics of movement – solidified to a sculpture!

"Splash" sets a charming course at the table and for interiors. The bowls are made of solid pewter, manually assembled of numerous single components and elaborately refined. Knobbed feet at the bottom side guarantee a safe stand.

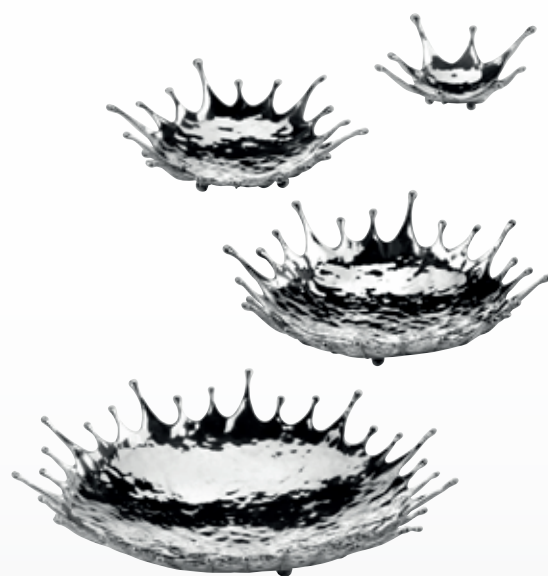

bowl "Splash"

pewter, hammered finish, polished, round, flat, food-safe, not dishwasher-safe, with supporting feet

item	Ø/height in cm	inside usable area Ø in cm
2340.15	15/5	6
2340.22	22.5/5.5	13
2340.28	28/6.5	19
2340.38	38/8	29

The service trays "Orbis" are made of solid brass and furnished with a matt surface structure. The modern appearance of these products results from the matt-golden tint and the reduced creation. The trays are available in two sizes and predestined for the use in a bar, on the buffet or the service in a restaurant.

All trays are food-safe sealed, nevertheless the direct contact with food should be avoided. Primarily, the varnishing prevents from too rapid formation of patina, which is inevitable for brass. In the long term, this patina is actually desired as it is exactly this matured colour, occurring in the course of time and use, which exudes a very special charm. By and by, these trays become more and more beautiful, each piece evolves into a unique copy.



patina



Please note:

Brass items are only suitable for cold/dry food. Do not clean in the dishwasher.



serving tray "Orbis"

brass (transparent coating, food-safe), not dishwasher-safe

item	Ø in cm	height in cm
2378.30	30	3
2378.40	40	3



→ Buffet display "Stompl" | p. 16



bowl "Matrix"
brass, top golden (transparent coating, food-safe),
bottom dark patinated, hexagonal, flat, not dishwasher-
safe

item	Ø in cm	height in cm
2382.38	38	7



bowl "Roots"
brass, golden (transparent coating, food-safe), round,
not dishwasher-safe

item	Ø in cm	height in cm
2381.38	38	8



bowl/display "Fakir"
brass, inside golden (transparent coating, food-safe),
outside dark patinated, not dishwasher-safe

item	Ø in cm	height in cm
2380.07	75	11
2380.12	12.5	10
2380.15	15	8.5
2380.18	18	9.5

Massive brass, produced in traditional sand casting, creates unique sculptural items, which enthuse especially by their contrast between matt golden surfaces and dark patination.

The bowls "Roots", a tight web of rootlike structures, and "Matrix", strictly geometrically constructed of hexagons, are entirely different in their shape but nevertheless belong together. This aspect makes the combination of the two so interesting.

An interesting add-on to the "Fakir" bowls are round glass platters of the Zieher product range. These can be laid on easily and thus generate the option to use the impressive objects on both sides.

All items are golden-coloured and partially dark patinated, further discolouration or oxidation is prevented reliably by the food-safe sealing of the golden parts.



→ Buffet stands "Somnia" | p. 29



i The silicone feet may be attached if needed

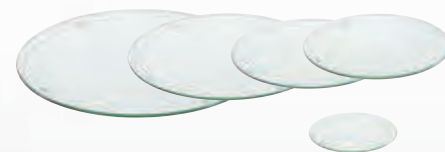

coaster/glass insert
clear glass, 4 mm thick, edges polished and deburred,
with 4 transparent rubber feet

item	Ø in cm	PU
5244	13	6 pcs
5244.17	16.7	1 pc
5244.21	20.7	1 pc
5244.24	24.2	1 pc
5244.28	28.2	1 pc



Please note:

The items made of brass are suitable for cold/dry food only, not dishwasher-safe.

→ Rechargeable LED-light 8150 | p. 53



Please note:
Suitable for cold and dry food, not dishwasher-safe.



bowl "Capiz"
shell, ivory-coloured, oval, resin-coated, not dishwasher-safe

item	l x w x h in cm
7106.46	46.5x24x13.5



bowl "Capiz"
shell, ivory-coloured, double-walled, round, with slightly cone-shaped bot tom, rim approx. 3 cm wide, resin-coated, not dishwasher-safe

item	Ø in cm	height in cm
7112.36	36	17.5



bowl "Capiz"
shell, ivory-coloured, double-walled, round, rim approx. 2 cm wide, resin-coated, not dishwasher-safe

item	Ø in cm	height in cm
7109.46	46	23



i Separates ice and melt water

charger plate, white glass
special hardened safety glass, 4 mm thick, white, edge polished, dishwasher-safe, with rubber feet (adhesive), underside scratch-proof

item	Ø in cm
1671.33	33



bowl "Capiz"
shell, ivory-coloured, double-walled, round, rim approx. 2 cm wide, resin-coated, not dishwasher-safe

item	Ø in cm	height in cm
7109.46	46	23



bowl "Medusa"
massive stainless steel 18/10, organically shaped, hammered, polished

item	l x w x h in cm
2120.15	15.5x15.5x14
2120.25	25.5x25x16.5
2120.38	38x38x23

"Medusa" – risen from the deep-sea

The tentacles, modelled in numerous processing steps, appear very filigree, but they still provide a safe base. Despite the solid stainless steel, these hammered bowls award a natural airiness and an almost floating impression. "Medusa" offers the perfect setting for all sorts of seafood or extravagantly presented salads and desserts. Even as a decorative storage space, these bowls cut a good figure.





bowl "Loop"
massive stainless steel 18/10, oval, hammered, polished, with black marble foot

item	l x w x h in cm
2109	approx. 39x19x67



bowl "Sixth Sense"
massive stainless steel 18/10, oval, hammered, polished, with stainless steel feet

item	l x w x h in cm
2171	approx. 48x25x74
2171.01	approx. 37x17.5x54
2171.02	approx. 20x12x34



The exceptional design of the "Art de Buffet" series acts as an eye-catcher at both modern and elegantly traditional buffets. It presents artistically arranged dishes in a favourable way. Every piece of this series is made of massive stainless steel 18/10, has a hand-made hammered finish and is six times hand-polished.



bowl "Wings"
massive stainless steel 18/10, hammered, polished

item	l x w x h in cm
2169	approx. 34x22x48



Feet ensure safe standing

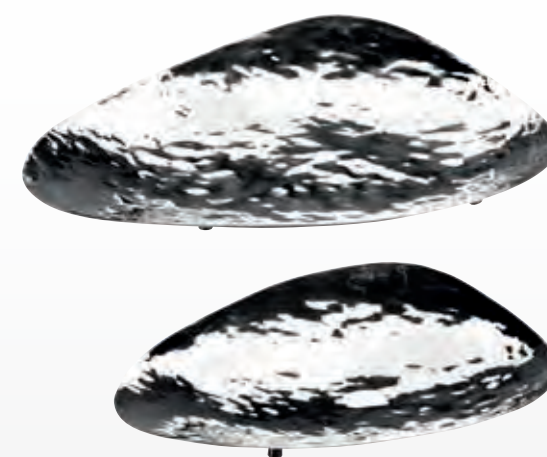

bowl flat
massive stainless steel 18/10, hammered, polished

item	l x w x h in cm
2206.50	50x40x6.5
2206.60	60x46x7.5

Please note:
The baseplate has to be mounted!



2141.01 + 2174



buffet stand
massive stainless steel 18/10, highly polished

item	Ø in cm	height in cm
2141.01	25/20	13
2141.02	27/22	17.5
2141.03	29/25	23



bowl
massive stainless steel 18/10, triangular, smooth finish, polished

item	Ø in cm	height in cm	content in l
2182.09	9	4	0.08
2182.13	13	6	0.28
2182.22	22	10.5	1.25
2182.30	30	12	3.0

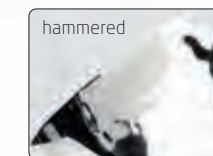

bowl
massive stainless steel 18/10, triangular, hammered, polished

item	Ø in cm	height in cm	content in l
2180.09	9	4	0.08
2180.13	13	6	0.28
2180.22	22	10.5	1.25
2180.30	30	12	3.0
2180.40	40	16	7.0

etagere
massive stainless steel 18/10, triangular, smooth finish, polished, not demountable

item	Ø in cm	height in cm
2187	13	16.5



bowl
massive stainless steel 18/10, round, hammered, polished

item	Ø in cm	height in cm	content in l
2181.17	17	6.5	1.1
2181.21	21	8	2.0
2181.24	24	9.5	3.25



bowl
massive stainless steel 18/10, oval, hammered, polished

item	l x w x h in cm	content in l
2183	40x23x18.5	approx. 1.7

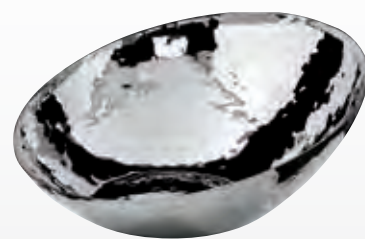

bowl
massive stainless steel 18/10, oblique, hammered, polished

item	Ø in cm	height in cm
2174	38	7/15



Please note:  When cleaning in the dishwasher, the brass rim may change its colour in the course of time. Therefore it is recommended to clean these items by hand.



etagere "Artisan"
stainless steel 18/10, inside polished, outside matt finish, round, not dishwasher-safe, hammered rim with golden adornment (brass), with brass handle, demountable, with 3 rubber feet

item	Ø in cm	height in cm
2376	33/28/23	45



The trays and bowls of the "Artisan" series are fascinating and diversified at the same time. The inside with its perfectly polished surface creates an interesting contrast to the matt outside. The handcrafted rim impresses by its irregularity and is crowned by a circumferential brass edge. The combination of hammered and plain surfaces, of massive stainless steel and brass, awards this series with that certain something.



bread/pastry bowl "Artisan"
stainless steel 18/10, inside polished, outside matt finish, oval, flat, hammered rim with golden adornment (brass), bottom smooth finish

item	l x w x h in cm	content in l
2372	22x15x3.5	approx. 0.5



bread/pastry bowl "Artisan"
stainless steel 18/10, inside polished, outside matt finish, oval, high, hammered rim with golden adornment (brass), bottom smooth finish

item	l x w x h in cm	content in l
2373	22x13x7	approx. 0.4



tray "Artisan"
stainless steel 18/10, inside polished, outside matt finish, round, hammered rim with golden adornment (brass), utility space smooth finish

item	Ø in cm	height in cm
2370.23	23	approx. 2.5
2370.28	28	approx. 3
2370.33	33	approx. 3



bowl "Artisan"
stainless steel 18/10, inside polished, outside matt finish, round, hammered rim with golden adornment (brass), utility space smooth finish

item	Ø in cm	height in cm	content in l
2371.07	7.5	3.5	approx. 0.1
2371.11	11	5.5	approx. 0.3
2371.14	14.5	7	approx. 0.7



tray "Artisan"
stainless steel 18/10, inside polished, outside matt finish, oval, hammered rim with golden adornment (brass), utility space smooth finish

item	l x w in cm	height in cm
2374.24	24.5x15	approx. 1.5



Thermo bowls "Shine"



The stainless steel bowls of the "Shine" series are double-walled and therefore have an insulating effect. This helps to prevent water condensation – even at higher temperatures. Cold food stays cold and warm food stays longer.

The accentuated contrast between the highly polished outside and the unobtrusive finish on the inside (fine brushed stainless steel) makes that series an eye-catcher.



bowl "Shine"

stainless steel 18/10, outside polished, inside satiné, double-walled, round/oblique, dishwasher-safe

item	Ø in cm	height in cm	content in l
2260.16	15.7	6.7/8.8	0.5
2260.20	19.7	8.5/11	0.9
2260.24	23.7	10/13	1.6

Bowls made of grey glass



→ Buffet displays "Classy" | p. 49



glass bowl

glass, 8 mm thick, dark grey, oval, with tree bark structure

item	l x w x h in cm	PU
5701	26.5x19.5x4.5	3 pcs



glass plate

glass, 8 mm thick, dark grey, oval, with tree bark structure

item	l x w in cm	PU
5700	33x24	3 pcs

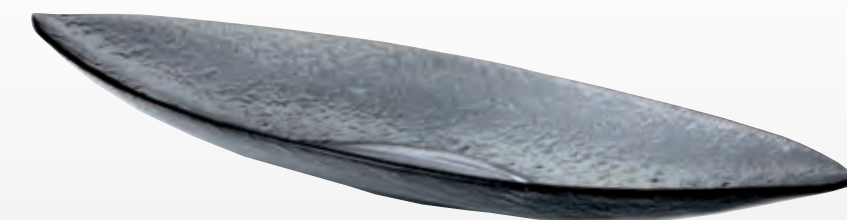

buffet bowl

glass, 8 mm thick, dark grey, oblong, structured

item	l x w x h in cm
5703	96x29x10



glass plate

glass, 8 mm thick, dark grey, rectangular, with tree bark structure

item	l x w in cm	PU
5702	40x22	2 pcs



→ Further variations of the "Crossline" buffet stands | p. 30/31



buffet bowl

glass, 8 mm thick, dark grey, oval, structured, delivery in strong wooden box

item	l x w x h in cm
5176	130x42x8

glass bowl

glass, 6 mm thick, dark grey, oval, structured

item	l x w x h in cm
5175.41	41x19.5x5.5
5175.44	44.5x25x6

buffet stand "Crossline"

galvanised steel, matt black (powder coating), rectangular, hinged beams on top

item	l x w x h in cm	l x w in cm (on top)
8325.23	70.5x33.5x23.5	59.5x22



→ Rechargeable LED-light item 8150 | p. 53

This monumental bowl made of dark grey glass arches like a sculpture and melts optically with crushed ice to stage classy seafood or champagne in an opulent way. In combination with the Zieher rechargeable LEDs, which perfectly accentuate the irregular structure of the glass, the presentation becomes even more dramatic! This effect is further intensified by the optical refraction of the ice.

This impressive bowl with a diameter of 82 cm can be placed free-standing on the floor by using the fitting rack (item 8213). But also right at the buffet table or arranged together with the stands of the "Crossline" series in different heights – these designer pieces know how to impress.

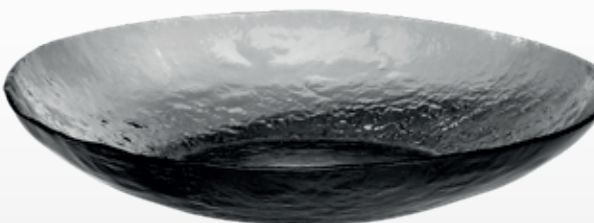

buffet bowl

glass, 8 mm thick, dark grey, round, structured, delivery in strengthened carton

item	Ø in cm	height in cm
5704	82	15



rack for XXL bowls

steel, matt black (powder coating), three-part for self assembly, adjustable feet for firm positioning on most surfaces, for XXL bowl "Konkret!" item 8212.D and XXL glass bowl item 5704

item	l x w x h in cm
8213	70x70x57



buffet stand "Crossline"

galvanised steel, matt black (powder coating), square, hinged beams on top

item	l x w x h in cm	l x w in cm (on top)
8320.15	41.5x41.5x15.5	34x34
8320.31	49.5x49.5x31	34x34

"Cave"



The glass version of the "Cave" bowl is available in two sizes. The soft tinge of this grey glass at first glance allows an unobstructed view onto the content of these shapely objects. "Cave" offers the fitting framework for fruit, nuts and nibbles as well as for tastefully arranged pasta or salad. The content of the bowls remains protected by the shell of glass, the amply dimensioned opening seduces to snap at a chance. These unique items also enthuse as a place to keep all kinds of accessories. The smaller version, made of china, is available on page 184.



glass bowl "Cave"

dark grey, round, handblown

item	Ø in cm	opening Ø in cm	height in cm
4815.18	approx. 18	approx. 14	approx. 11.5
4815.24	approx. 24	approx. 19	approx. 16.5

"Duplex"



The "Duplex" bowls, which can be used on both sides, create a harmonious setting for stylishly arranged dishes. If the closed side is turned upwards, a gentle trough is created for presenting sophisticated dishes. By using it upside down, there will be more capacity, which is ideal e. g. to fill in crushed ice.



glass bowl "Duplex"

dark grey, round, bottom side open, useable on both sides

item	Ø in cm	height in cm
4813.28	28	6.5
4813.35	35	7.5
4813.46	46	10



Handblown bowls

Please note: 

All items shown on this pages are handblown. Therefore it is impossible to avoid variations in glass thickness, colour intensity and weight.

Item 4814.17 is varnished. Therefore we recommend hand washing for this bowl!

The handblown bowls made of grey tinted or varnished glass (4814.17) are restrained in their shape, but very versatile in their appearance. By combining the bowls with the gold-coloured stands of the "Somnia" series (page 29), opulent and extravagant buffet stagings can be created.

Optionally available silicone rings form a non-slip base and increase stability.



glass bowl

dark grey, round, handblown, ground edge

item	Ø in cm	height in cm	content in l
4814.17	17	5.5	approx. 0.3
4814.23	23	9.5	approx. 1.5
4814.30	30	13	approx. 3.25
4814.40	40	10	approx. 4.5

 We recommend the use of silicone ring 4681.S with the smallest bowl item 4814.17

ring "SelectionA."

silicone, Ø 8.3cm, for glass bowl item 4814.17

item	colour	PU
4681.S	black	6 pcs

4814.17 + 4681.S



4814.23 + 4682.S



ring "SelectionA."

silicone, Ø 13.4 cm, for glass bowls item 4814.23 and 4814.30

item	colour	PU
4682.S	black	3 pcs

stand/ring, illuminatable

silicone, black, Ø 15.2 cm, usable as an optional stand, for glass bowls item 4814.23 and 4814.30, suitable for rechargeable LED-light item 8150

item	Ø in cm	height in cm
4679.S	15.2	5.5



buffet bowl
glass, satined, square

item	l x w in cm
5014.38	38x38



glass platter
glass, structured, transparent, square

item	l x w in cm
5063	30x30
5063.50	50x50

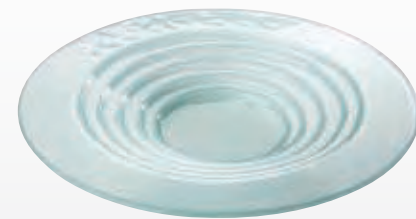

buffet bowl
glass, satined, concentric shape with steps

item	Ø in cm	height in cm
5013.46	46	5.5



buffet bowl
glass, transparent, wide rim, structured

item	Ø in cm	height in cm
5049.35	35	6



buffet bowl
glass, transparent, wide rim, structured

item	Ø in cm	height in cm
5024.45	45	11



→ Etagere "DressCoat" | p. 94
→ Plates "Unique" | p. 166



glass bowl "Unique"
glass, white marbled, outside satined, round

item	Ø / height in cm	content in l	PU
5182.16	16/5	approx. 0.67	6 pcs
5182.21	21/8	approx. 2.0	4 pcs
5182.27	26.5/8	approx. 2.75	4 pcs



"Unique"

Manufactured in old tradition

Each of these high grade bowls is unique and almost completely handcrafted. At this, coloured glass is completely covered with crystal clear glass, which awards the bowls with top brilliance and an impressive look. The handblown glass blank is modelled manually, whereby unique pieces are created which excite by their organic shape.



bowl
clear glass, white, handblown, wavy, with clear rim

item	Ø in cm	height in cm
4810.01	approx. 38-40	approx. 9.5
4810.02	approx. 50-52	approx. 14



Please note:

Due to the complex production process, small air inclusions in the glass are inevitable.



Etagere "DressCoat"



Food: Pâtisserie Walter
www.patisserie.de

→ "DressCoat" | p. 182
→ "Unique" | p. 166



i We recommend the use of large plates on the lower level only

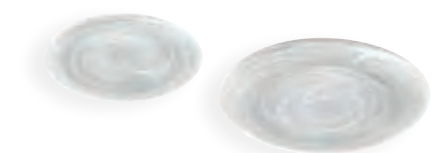

glass plate "Unique"
glass, white marbled, bottom satined, round

item	Ø in cm	PU
5178.21	21	6 pcs
5178.28	28	6 pcs



plateau plate "DressCoat"
white china, useable area (plateau): Ø 19.5 cm, also useable as a bowl

item	Ø / height in cm	content in l	PU
4388	22/6.5	0.9	3 pcs



Anti-slip-rings

etagere "DressCoat"
massive stainless steel 18/10, hammered, polished, 3-armed

item	Ø in cm	height in cm
2212.30	36	30





A Tribute to the Beauty of Nature

"Fleur Déco" embodies the true essence of luxury combined with elegance and, at the same time, pays homage to the art of craftsmanship.

Each component of these unique pieces is cast from brass and meticulously finished to achieve the perfect balance between golden and dark patinated areas. Each blossom, each branch is carefully assembled by skilled hands to create a harmonious and floral appearance that seamlessly blends natural beauty with functionality.

The series includes a three-tiered etagere for plates and dishes up to 22 cm in diameter. This beautiful etagere provides space for a variety of dishes and adds a highly elegant touch to every buffet or table setting. A serving platter, from the center of which a decorative plant emerges, serves as a centerpiece on any table. The buffet tree is a masterpiece of floral design, offering space for numerous culinary delights on its ten leaves.

"Fleur Déco" is the perfect choice for discerning hosts who value exceptional quality and design, and who give a high significance on both the taste and presentation of their culinary creations.



i You will find a selection of suitable plates and platters on page 268.



→ glass inlay



→ plate "Bolla"



→ plate "Bosque"



→ plate/bowl "Sombre"



etagere "Fleur Déco"
brass, golden/antique (transparent coating, food-safe), with 3 levels (Ø inside: 23 cm), not dishwasher-safe

item	Ø in cm	height in cm
2387	36	approx. 55



etagere "Fleur Déco"
brass, golden/antique (transparent coating, food-safe), Ø bottom plate 22 cm, with 10 miniature plates (approx. 13 cm x 8 cm), not dishwasher-safe

item	Ø in cm	height in cm
2388.10	40	approx. 47.5



serving tray/platter "Fleur Déco"
brass, golden/antique (transparent coating, food-safe), Ø bottom plate 22 cm, not dishwasher-safe

item	Ø in cm	height in cm
2389	22	approx. 24

Please note:

All items of the "Fleur Déco" series are food-safe, allowing for the direct placement of cold and dry foods on the etageres. For other purposes Zieher offers a wide selection of bowls as well as matching plates and dishes. Do not clean in the dishwasher.



"Flex-Tree"



The "Flex-Tree" enthuses by its versatility! On these trees, plain discs replace the fixed leaves. With a diameter of 5.5 cm, they offer sufficient space to equip the tree either with glass, porcelain or stainless steel miniatures. To be on the safe side, they can be placed on black or white anti-slip silicone pads. This reduces the sound emission and at the same time increases the stability of the used miniatures.

All trees are made of massive stainless steel and are accurately high gloss polished. The 8 mm thick foot is the perfect base and guarantees a safe stand.

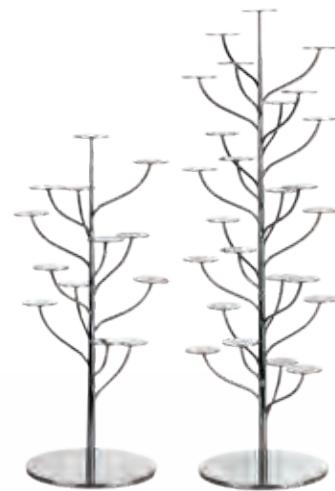

etagere "Flex-Tree"

massive stainless steel 18/10, smooth finish, polished, Ø 24 cm, with round discs (Ø 5,5 cm)

item	height	number of levels
2209.13	53	13
2209.25	72	25

"Flower-Tree"

"Flower-Tree" – A tree to dream of!
On 13 resp. 25 levels, these trees offer the possibility to present and showcase finger food, petit-fours and other delicacies. The shape of the leaves is based on the already existing plateau plates and "Flower-Tower" etageres (page 103). This opens up the option to arrange the buffet installations diversified and variable, but nevertheless harmoniously.

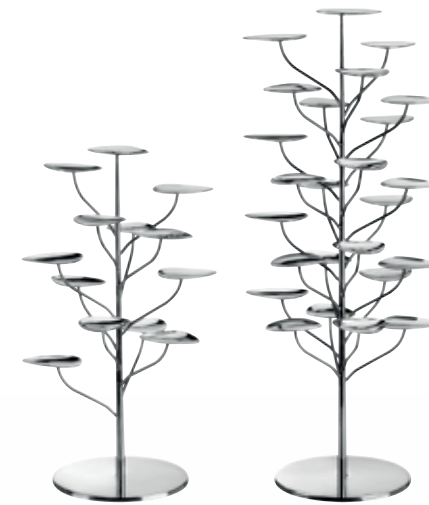

etagere "Flower-Tree"

massive stainless steel 18/10, smooth finish, polished, Ø 29 cm, with miniature plates (approx. 9 cm x 7,5 cm)

item	height in cm	number of levels
2208.13	51.5	13
2208.25	71	25



plateau plate "DressCoat"

china, white, also useable as a bowl

item	Ø / height in cm	content in l	PU
4386.01	9/4.5	0.1	12 pcs



miniature plate

china, round, flat, Ø 10.5 cm

item	colour	PU
4606.10	white, glossy	12 pcs
4607.10	black, matt	12 pcs



glass miniature plate

glass, 4 mm thick, green, structured, leaf shape

item	l x w in cm	PU
5037	14x7.5	12 pcs



coaster

silicone, Ø 5 cm, 3 mm thick, temperature resistant (-40 °C to +230 °C), food-safe, with rim on one side, for anti-slip placement of miniatures

item	colour	PU
4661.05S	black	24 pcs
4661.05W	white	24 pcs



→ Miniature plateau plate | p. 104

"Table-Tree"



Tempting variety on the buffet

For the presentation of filigree delicacies in the smallest of spaces, the new "Table-Trees" offer numerous possibilities for a stylish staging.

A selection of fruit, chocolates or patisserie can be presented on the six organically shaped petals of the "Table-Tree" Flower. The "Table-Tree" Pin offers the possibility of presenting finger food or small snacks on six skewers at different heights. Each delicacy is held securely by an artfully shaped spiral that prevents from slipping.

The 30 cm high "Table-Trees" are made entirely of stainless steel by hand and polished to a high gloss. The solid base forms the basis of these filigree products and ensures a secure stand.



etagere "Table-Tree" Flower
massive stainless steel 18/10, smooth finish, polished, Ø 29 cm, with miniature plates (approx. 9 cm x 7.5 cm)

item	Ø in cm	height in cm	number of levels
2208.06	29	30	6



etagere "Table-Tree" Pin
massive stainless steel 18/10, smooth finish, polished, Ø15 cm, with skewers and stoppers

item	Ø in cm	height in cm	number of levels
2210.06	15	30	6



"Flower Tower"



Floral shapes in a steely gloss

Seemingly organic shapes in an interplay with the gloss and reflections of hammered and polished stainless steel make up the special charm of this product line. Two etageres and plateau plates in different heights (page 104) allow a visually harmonious yet flexible and diversified presentation of appetizers or desserts on the buffet.

The ice cream/sorbet cups and petit-fours stands in various sizes make a nice complement and stage individually appetizers or a dessert.

Design: Itamar Harari



etagere with 3 tiers
massive stainless steel 18/10, hammered, polished, 21 miniature plates (approx. 9 cm x 8 cm)

item	Ø in cm	height in cm
2201	25	44.5



etagere with 1 tier
massive stainless steel 18/10, hammered, polished, 7 miniature plates (approx. 9 cm x 8 cm)

item	Ø in cm	height in cm
2202	25	9



ice cream cup with foot
massive stainless steel 18/10, hammered, polished

item	l x w x h in cm	content in l
2207.11	11.5x10x11	0.15
2207.15	13.5x11x15	0.25



amuse gueule stand with foot
massive stainless steel 18/10, polished

item	l x w x h in cm
2204.08	11.5x9.5x8.5
2204.11	11.5x9.5x11.5



The massive slate platters with their 3 resp. 24 holes form a stable base for various uses. Whether coil shaped holders with matching miniatures made of porcelain and glass, skewers made of high-gloss polished stainless steel or presentation platforms in different heights – the skewer platters from Zieher offer numerous options to present small delicacies in an appealing way.

skewer
stainless steel 18/10, polished, 24 cm long

item	version	PU
1939.01	Moon	12 pcs



miniature plate with rod

massive stainless steel 18/10, hammered, polished, plate approx. 9x8 cm, for slate platters 8054 and 8056

item	height in cm
2203.08	8
2203.13	13
2203.18	18
2203.23	23



Please note:

Positioning of plateau plates with the same height is only possible to a limited extend.



miniature
china, white, stackable

item	Ø / height in cm	content in l	PU
4490	5,1/7	0,1	6 pcs



glass miniature
borosilicate glass, transparent, handblown, double-walled, with reinforced rim

item	Ø / height in cm	content in l	PU
4901.03	6/7,5	approx. 0,08	6 pcs



glass miniature
clear glass

item	Ø / height in cm	content in l	PU
5405	5/8,6	0,1	6 pcs



holder coil shape

massive stainless steel 18/10, hammered, polished, for inserts made of china and glass, suitable for slate platters items 8054 and 8056

item	Ø in cm	total height in cm
2167.15	5,5	20
2167.20	5,5	25
2167.25	5,5	30
2167.30	5,5	35



platter, slate

natural slate, not sealed, rectangular, with 3 holes (Ø 5 mm), with 4 feet of felt (not dishwasher-safe), for holder coil shape items 2167... or skewer item 1939.01 or miniature plates items 2203... (please order separately)

item	l x w x h in cm
8054	30x10x2,5

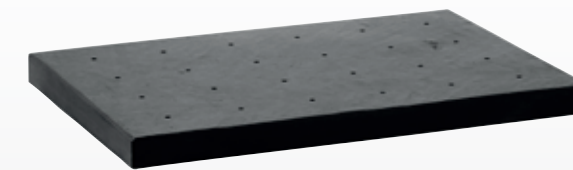

platter, slate

natural slate, not sealed, rectangular, with 24 holes (Ø 5 mm), with 4 feet of felt (not dishwasher-safe), for holder coil shape items 2167... or skewer item 1939.01 or miniature plates items 2203... (please order separately)

item	l x w x h in cm
8056	45x31x3



Please note:

These slate platters are unsealed. In order to give them an evenly dark grey colour and to freshen up the surface, we recommend rubbing the platters with some vegetable oil from time to time.



skewer plate, slate

natural slate, not sealed, rectangular, double, with 35 holes (Ø 3 mm), with 6 feet of felt (not dishwasher-safe)

item	l x w x h in cm
8051	35x25x2,6

i Item 8051: Drilled holes Ø 3 mm: suitable for usual skewers made of wood

"Fingerfood-Tree"

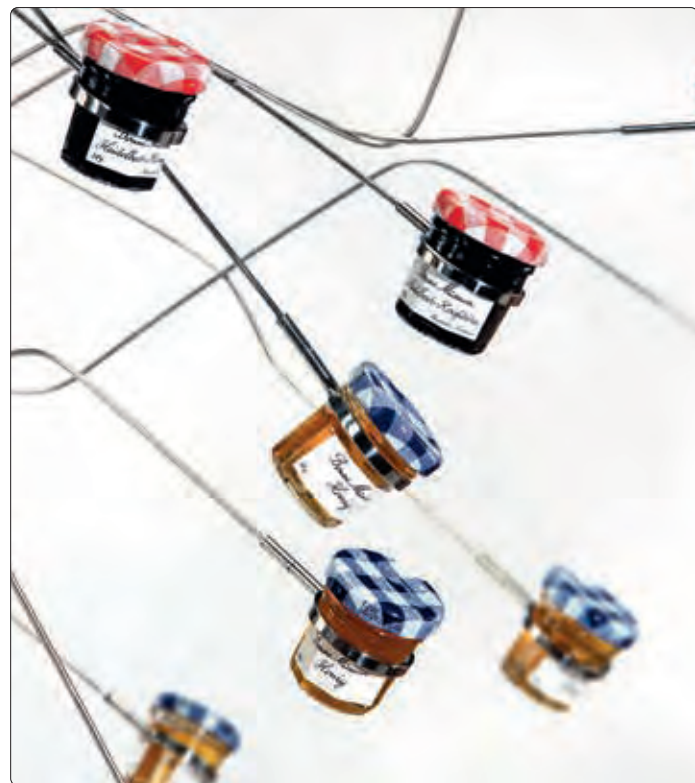

i Equipped with rings size M, the fingerfood-tree is perfectly suitable for presenting portion jam in conical glasses, e.g. Bonne Maman

Please note:

The trees are delivered with unbent branches; the bending has to be arranged before the first use!

The branches are made of stainless steel and will sag when loaded with food. This is why the branches should not be bent too far down when empty. In order to obtain a more favourable result, it is recommended to bend the branches one by one and to work in a circle from the outside to the inside.

The different attachments can be screwed onto the end of the branches, whereas the connection point should only be tightened up slightly. When using the rings or spiral supports, it is recommended to leave the connection point open by about half a turn, as they will turn into the apt position by themselves due to the weight of the attachments.

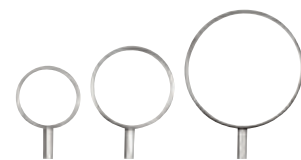

spring clip support

stainless steel 18/10, polished, to screw onto the "branches" of the fingerfood-tree item 8018.01

item	length in cm	PU
8019.01	7	10 pcs

spiral support

stainless steel 18/10, polished, to screw onto the "branches" of the fingerfood-tree item 8018.01

item	Ø in cm	height in cm	PU
8019.05	4.5	4.5	10 pcs

ring support

stainless steel 18/10, polished, to screw onto the "branches" of the fingerfood-tree item 8018.01

item	size	Ø in cm (inside)	PU
8019.02	S	2.8	10 pcs
8019.03	M	3.8	10 pcs
8019.04	L	5.6	10 pcs

glass cone

clear glass, for food display item 2194...

item	Ø / height in cm	content in l	PU
5415	3.5/8	0.03	12 pcs



i For ring size L



i For ring size S

glass miniature

borosilicate glass, transparent, handblown, double-walled, with reinforced rim

item	Ø / height in cm	content in l	PU
4901.03	6/7.5	approx. 0.08	6 pcs

Design: Jochen Gromann



transport bag

polyester, blue, with zip and 2 carrying straps, for fingerfood-tree item 8018.01

item	l x w x h in cm
8018.T	158x28x28



hook-and-loop strap

black, with chrome-plated clasp, for easy transport and space-saving storage of the fingerfood-tree item 8018.01

item	l x w in cm
5660	43x2.5



fingerfood tree

stainless steel 18/10, polished, 30 "branches" of equal length (87 cm) of stainless steel wire, with 6 feet of felt, height after bending of "branches": approx. 90 cm - 110 cm, threaded ends for attachment of several supports items 8019... (please order separately)

item	Ø in cm (foot)	height unbent in cm
8018.01	25	121



The fingerfood trees by Zieher are absolutely delightful due to their extraordinary look and variable uses achieved by the different attachments!

Besides a clip that holds wooden skewers and a spiral for small wraps and waffles, we offer rings in three sizes, of which the medium size is especially designed for holding small conical jam jars (e.g. Bonne Maman). Velcro straps to fasten the 30 branches and a stout carrier bag are available from the accessory section and allow easy transport and space-saving storage of the bent trees.

"Mikado"



"Mikado" – cool staging!

The bottle cooler "Mikado" is made of solid stainless steel and high gloss polished. Due to its weight and the generously dimensioned floor area, the solid frame has the required stability to offer the matching cooler made of hand-blown glass a secure hold.

Additional silicone rings on the upper side of the rods treat the glass body with care and avoid disturbing noise.

A very special highlight creates the optionally available waterproof LED-light, which can be placed right inside the cooler. Multiple colours and functions can be adjusted by a remote control, an optionally available supporting ring keeps the light in position. All information about the LED-light can be found on page 53.

The glass insert of the "Mikado" bottle cooler can also be used as cloche. The reinforced quality, which is indispensable for the use as a cooler, brings besides the slightly higher weight also an obviously improved stability. The integrated ball grip at the top provides an easy handling when used as a cloche (page 194).

Design: Itamar Harari



glass cloche/wine cooler

clear glass, handblown, reinforced version, with round handle, for coaster "Solid" item 4734.02 (as cloche) and wine cooler stand item 2220.70 (as wine cooler)

item	Ø in cm	height in cm
4848	22.5	26

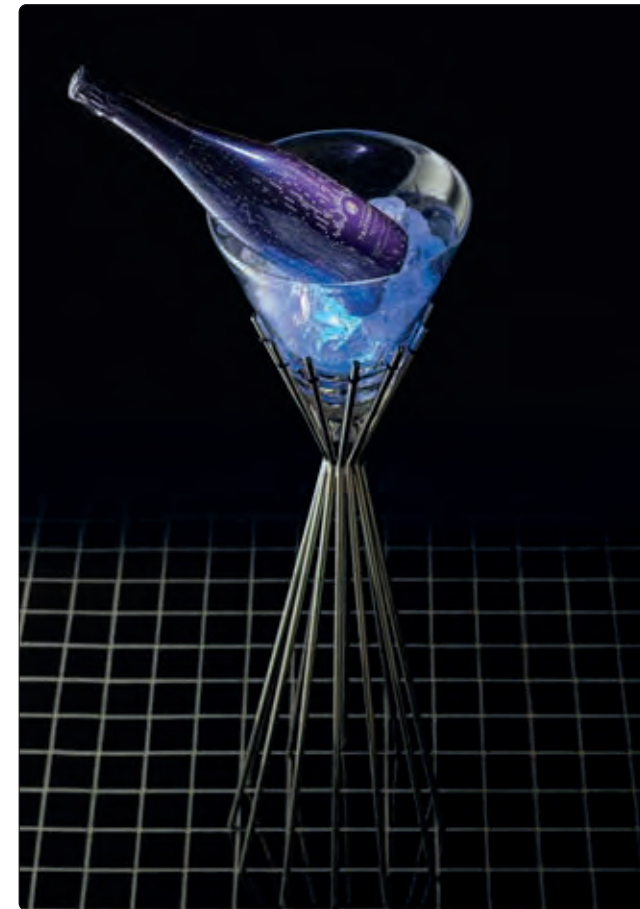

wine cooler stand "Mikado"

massive stainless steel 18/10, polished

item	Ø in cm	height in cm
2220.70	approx. 24	approx. 70

Stablo





i By positioning the cooler at an angle, it is also suitable for buffet stands "Stablo" M and L.



Positioning of ring and light

i
→ Rechargeable LED-light item 8150 and suitable accessories | p. 53



ring "SelectionA."
silicone, Ø 8.3 cm

item	colour	PU
4681.5	black	6 pcs

Please note:

For one buffet stand "Stablo" XL ring item 8016.01 only one set of extension is required.

Extension for buffet stand XL ring

801740: for a total height of 80 cm
801760: for a total height of 100 cm
801780: for a total height of 120 cm



wine cooler

borosilicate glass, transparent, handblown, handmade, reinforced version, for "Stablo" M, L items 8015.30 and 8015.40 (by positioning the cooler at an angle) and "Stablo" XL ring item 8016.01

item	Ø in cm	height in cm
4881.26	26	approx. 43



→ Also available separately on request

buffet stand "Stablo" XL-ring

massive stainless steel 18/10, polished, 12 mm thick, with ring-opening (Ø 12 cm inside) for wine cooler items 4881.26, with 6 anti-slip rubber caps, 3 of which are separately packed (to clip onto the bottom part while not using the extensions items 8017... please order the extensions separately)

item	Ø upper/lower in cm	height in cm	PU
8016.01	22.5/37	40	3 pcs



extension "Stablo"

massive stainless steel 18/10, polished, 12 mm thick, with anti-slip rubber caps, for buffet stand "Stablo" item 8016.01 (not suitable for items 8014... and 8015...)

item	length in cm	PU
801740	40	1 set (3 parts)
801760	60	1 set (3 parts)
801780	80	1 set (3 parts)

The buffet stands made of solid, brightly polished stainless steel impress by their high-quality workmanship and delicate appearance. Bowls and dishes appear almost hovering while slip-proof caps on the feet ensure safe support.



The buffet stand with integrated ring (item 8016.01) can be extended to heights between 80 cm and 120 cm with matching extensions. Massive and bulky buffet tables thus become almost superfluous! In addition to placing bowls, plates and platters (max. Ø 21 cm on the lower level), it can also accommodate unusual wine coolers made of borosilicate glass. These can also be placed in the "Stablo" stands in sizes M and L when positioned at an angle.

The shape of the coolers corresponds to the already known Zieher clothes (p. 191 to 193); borosilicate glass in a reinforced quality guarantees the necessary stability! Condensing water on the outside is drained off to the bottom tip. Dripping water can be collected by placing a small bowl on the floor or buffet table! Optionally available Zieher rechargeable LED-lights put champagne and iced food in the limelight!



buffet stand "Stablo" XXS, XS

massive stainless steel 18/10, polished, 8 mm thick, with 6 anti-slip rubber caps

item	Ø upper/lower in cm	height in cm	PU
8014.13	15/20.5	13.5/XXS	3 pcs
8014.20	15/23	20/XS	3 pcs

buffet stand "Stablo" S, M, L

massive stainless steel 18/10, polished, 10 mm thick, with 6 anti-slip rubber caps

item	Ø upper/lower in cm	height in cm	PU
8015.20	22/30	20/S	3 pcs
8015.30	22/35	30/M	3 pcs
8015.40	22/39	40/L	3 pcs



Design: Uwe Kopp, Jörg Stricker



base tray "Modul"
melamine, black, surface matt, food-safe, not suitable for microwave and combi steam oven

item	l x w x h in cm	PU
4582	72.5x28x1.8	2 pcs

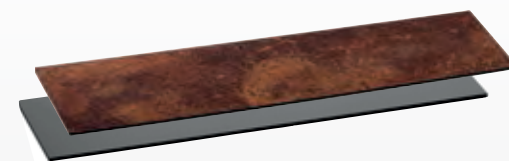

tray
massive stainless steel 18/10, rectangular, hammered, polished, for buffet etagere items 2193 and 8013

item	l x w x h in cm
2193.01	62x18x5

base tray "Modul"
walnut, food-safe sealed, not dishwasher-safe, stackable

item	l x w x h in cm
4722	70x25.5x3.1

buffet platter
hardened glass, 10 mm thick, rectangular, edges polished and deburred

item	version	l x w in cm
5243	clear glass	80x21
5243.M	satined	80x21

buffet platter
laminated plastic, 8 mm thick, rectangular, black intermediate ply, break-proof, dishwasher-safe, antistatic, deburred edges, rounded corners

item	version	l x w in cm
8007.08	rusted look	80x21
8006.08	dark grey	80x21



The three-staged buffet etagere offers a lot of space for all kinds of food. It can be equipped with numerous trays and plates of the Zieher range. Anti-slip caps avoid annoying noise and ensure the safe grip of the trays.



buffet etagere "Stablo"
massive stainless steel 18/10, 10 mm thick, with 4 anti-slip rubber caps and 24 rubber pads (for anti-slip placing of the trays), support for trays: 46.5 cm x 13 cm

item	l x w x h in cm
8013	46.5x54.5x30



glass tray
glass, dark grey, rectangular

item	l x w x h in cm
5161.31	31x21x3.5
5161.62	62x21x3.5



glass tray
glass, satined, rectangular

item	l x w x h in cm
5160.31	31x21x3.5
5160.62	62x21x3.5



buffet platter
special hardened safety glass, 4 mm thick, rectangular, rounded edges, polished rim, dishwasher-safe, rubber feet included (adhesive), underside scratch-proof

item	version	l x w in cm
1668.08	black glass	80x21



coup plate "Catering"
china, white, round, flat

item	Ø in cm	PU
3954.21	21	12 pcs



i Anti-slip sleeves provide a safe positioning of buffet platters

→ more buffet platters made of laminated plastics and glass | from p. 56



buffet platter, black glass

special hardened safety glass, 4 mm thick, black, rounded edges, polished rim, dishwasher-safe, rubber feet included (adhesive), underside scratch-proof

item	version	l x w in cm
1668.08	rectangular	80x21
1668.22	rectangular	91x21
1668.24	rectangular	102x21



buffet platter, laminated plastic

laminated plastic, 8 mm thick, dark grey, black intermediate ply, break-proof, scratch-proof, dishwasher-safe, antistatic, deburred edges, rounded corners

item	version	l x w in cm
8006.08	rectangular	80x21
8006.14	rectangular	91x21
8006.15	rectangular	102x21



etagere "Falcon"

massive stainless steel 18/10, highly polished, dishwasher-safe, food-safe, anti-slip silicone sleeves for use with buffet platters included

item	l x w x h in cm
8086	24x20x45

"Falcon" – really detached!

This etagere is giving wings to the creativity at the buffet. A single one can bear up to three plates on its wings or, when used as a duo, fitting buffet platters or a combination of both can be installed. Anti-slip supports can be plugged on if needed and thus provide a safe positioning of the platters.

As a high-tea stand, the etagere carries coup plates made of porcelain. Those plates fit exactly into the slots of the wings.

The mirror polished, solid stainless steel (3 mm) punctuates the precious impression of the dynamic shape, incorporated handrails facilitate the service.

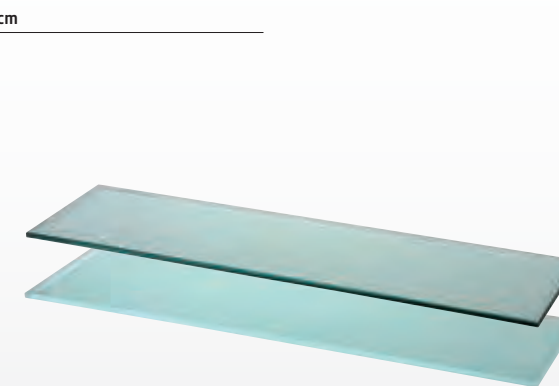
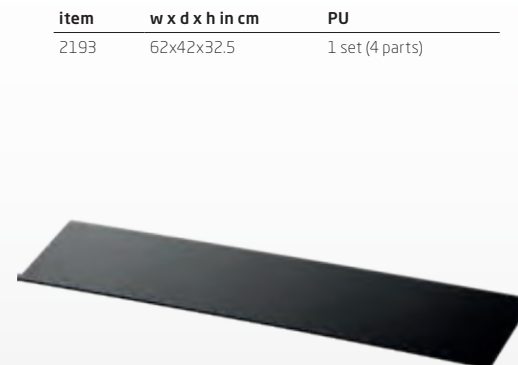
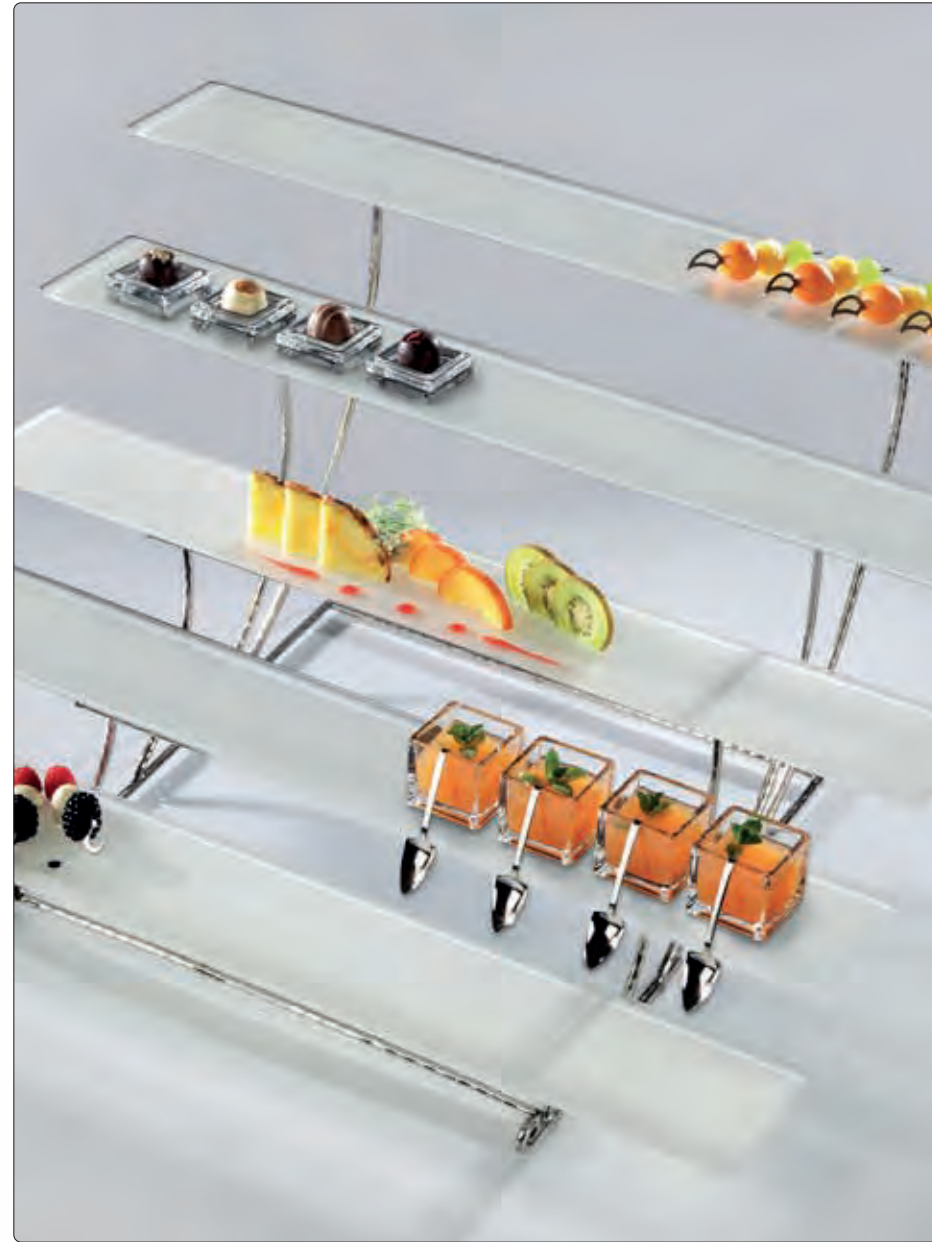

tray
massive stainless steel 18/10, rectangular, hammered, polished, with feet, for buffet etagere item 2119

item	l x w x h in cm
2119.01	66x8x3

buffet platter
special hardened safety glass, 4 mm thick, rounded edges, polished rim, dishwasher-safe, rubber feet included (adhesive), underside scratch-proof

item	version	l x w in cm
1670.12	white glass	66x10

buffet etagere
massive stainless steel 18/10, hammered, polished, including 5 trays item 2119.01 (66 cm long, 8 cm wide, 3 cm high)

item	w x d x h in cm	PU
2119	66x54x32	1 set (6 parts)

buffet platter
special hardened safety glass, 4 mm thick, rectangular, rounded edges, polished rim, dishwasher-safe, rubber feet included (adhesive), underside scratch-proof

item	version	l x w in cm
1668.08	black glass	80x21

buffet platter
hardened glass, 10 mm thick, rectangular, edges polished and deburred

item	version	l x w in cm
5243	transparent glass	80x21
5243.M	satined glass	80x21

buffet platter
laminated plastic, 8 mm thick, middle layer black, break-proof, dishwasher-safe, antistatic, deburred edges, rounded corners

item	version	l x w in cm
8007.08	rusted look	80x21
8006.08	dark grey	80x21



→ Glass trays | p. 113



buffet etagere
massive stainless steel 18/10, hammered, polished, including 3 trays item 2193.01 (62 cm long, 18 cm wide, 5 cm high)

item	w x d x h in cm	PU
2193	62x42x32.5	1 set (4 parts)

tray
massive stainless steel 18/10, rectangular, hammered, polished, for buffet etagere items 2193 and 8013

item	l x w x h in cm
2193.01	62x18x5



tray
massive stainless steel 18/10, rectangular, hammered, polished, with feet, for etagere item 2110

item	l x w x h in cm
2110.01	30x8x3



Tilttable handle

etagere
massive stainless steel 18/10, hammered, polished, including 3 removable trays item 2110.01 (30 cm long, 8 cm wide, 3 cm high)

item	l x w x h in cm (etagere only)
2110	11.5x11.5x39 (height without handle)



2107.03 + 4606.10 2107.03 + 4607.10



etagere
massive stainless steel 18/10, hammered, polished, with 3 insertion levels (Ø inside: 6.5 cm) for plates/bowls with max. Ø 11 cm

item	l x w x h in cm	levels
2107.03	12.5x11.5x23	3



Elegantly served and presented in style - classic plate etageres, newly inspired!

Shapely and individual stands by Zieher are suitable for numerous applications. The classic plate etageres are available with three levels and in two sizes. The classic mini format etageres effectively present petit fours, desserts, chocolates or other delicacies. The larger version is ideal for scones and jam during Five o'Clock Tea, but also a choice of cold cuts, cheese or fruit can be staged elaborately on the set table. Suitable inserts made of china or stainless steel are available on page 274 and 275.



etagere
massive stainless steel 18/10, hammered finish, polished, with 3 insertion levels (Ø inside: 10.8 cm) for plates/bowls with max. Ø 17.5 cm

item	l x w x h in cm	levels
2105.03	20.5x18x37.5	3



tray
massive stainless steel 18/10, square, hammered, polished, with feet

item	l x w x h in cm
2101.17	17.5x17.5x2.3



2105.03 + 4607.17



2105.03 + 4606.17



2105.03 + 2101.17



→ Jam-Trays | p. 281



toast rack
massive stainless steel 18/10, hammered, polished, for 4 slices of toast

item	l x w x h in cm
2190	20x8.5x15



pastry tray
massive stainless steel 18/10, rectangular, hammered, polished

item	l x w in cm
2136	30x12.5



serving tongs
massive stainless steel 18/10, hammered, polished

item	length in cm
2140	21.5



serving tongs
massive stainless steel 18/10, hammered, polished

item	length in cm
2139	28



chocolate/ice cube tongs
massive stainless steel 18/10, hammered, polished

item	length in cm
2138	19



spoon rest
massive stainless steel 18/10, rectangular, hammered, polished

item	l x w in cm
2154	18x10



tongs holder
massive stainless steel 18/10, hammered, polished, for tongs up to a length of 24 cm

item	l x w x h in cm
2115	27.5x9.5x28

Please note:
The tongs have a thickness of 4 mm, they rest perfectly in the hand and convey a sense of quality.

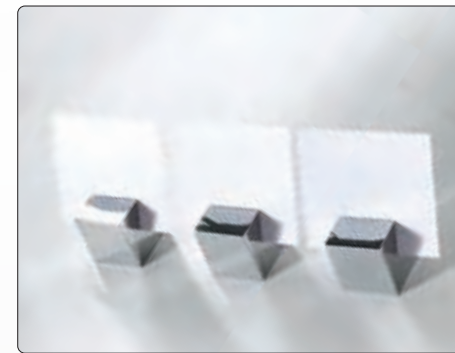

card holder
walnut, varnished, slot 2 mm wide

item	l x w x h in cm	PU
4726	8x3x3	4 pcs

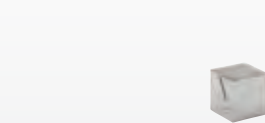

card holder
stainless steel 18/10, polished, heavy quality, slot 1 mm wide

item	l x w x h in cm
3461	2.5x2.5x2.5



ashtray for cigars
optical glass, transparent, also usable as a rest for tongs or spoons, in black gift box

item	l x w x h in cm
5210	15x9x3



small glass bowl/spoon rest
glass, 4 mm thick, structured, dark grey, organically shaped, slightly oval form

item	l x w in cm	PU
5172	11x7.5	12 pcs

“Solid”



→ Further sizes and variations of the cloches | from p. 124



buffet platter, glass

special hardened safety glass, 49 cm long, 21 cm wide, 4 mm thick, with 2 concave cutouts, rounded edges, polished rim, dishwasher-safe, rubber feet included (adhesive), underside scratch-proof

item	colour
1668.20	black
1670.20	white



cutting board “Solid”

walnut (end grain), oiled, stackable, not dishwasher-safe, with juice rim/groove to place cloches

item	Ø in cm	height in cm
4776	29	5



stacking ring “Solid”

walnut wood, oiled, not dishwasher-safe, with stacking rim to place cloches

item	Ø in cm	height in cm
4777	29	8.5



bowl “Solid”

walnut, oiled, not dishwasher-safe, with stacking rim to place cloches

item	Ø in cm	height in cm
4778	29	8.5



glass cloche

clear glass, handblown, with round handle

item	Ø in cm	height in cm
4852	26	43



glass cloche

borosilicate glass, transparent, handblown, handmade

item	Ø in cm	height in cm
4880.26	26	approx. 41-44



Please note:



The Zieher cutting boards are oiled. The use naturally wears down their surfaces. In case of smaller abrasions, rub down the surface with a thin layer of vegetable oil or special care oil for wood kitchen countertops to refresh the surface. The above mentioned items are not dishwasher-safe. Please check the enclosed leaflet for detailed instructions.

“Solid”



The high-quality cutting board made of fine end grain walnut wood is much more than a shapely and elegant kitchen aid. This product only unfolds its full potential in connection with the respective stacking rings and bowls.

All parts have a groove at the top, which allows quick and easy stacking of the various items. The milled groove of the cutting board serves on the one hand as a juice groove, on the other hand as a receptacle for various glass cloches. Thus aromatic types of cheese can be presented. A classic cloche made of handblown glass or an extravagant shaped cover made of highly durable borosilicate glass protects and stages the food at the same time. The stacking ring creates different levels of presentation when used in a clustered arrangement of cutting boards and trays. Also, the capacity of the bowls can be increased.

Accurately fitting connection plates made of hardened, white or black coloured glass, can be slid exactly into the grooves of the stacked rings and thus work as buffet platters between the columns. This creates additional space and raises the flexibility of this system at the same time.

Cutting board, ring and bowl are sealed with high quality oils. Especially regarding the cutting board, this enables the simple refurbishment of the surface.



Handblown cloches



Each cloche on this page is handblown and handcrafted. In contrast to the cloches made of borosilicate glass (page 125), these items are made of a single massive glass drop. Air inclusions and minor streaks are a sign of individuality and cannot always be avoided.



glass cloche

clear glass, for pastry/cake stand items 5349...

item	Ø in cm	height in cm
5350.16	16	13
5350.23	23	16.5
5350.27	27.5	20.5



pastry/cake stand

clear glass, with foot

item	Ø in cm	Ø stand in cm	height in cm
5349.21	21	10.5	9.5
5349.28	28	13	11.5
5349.33	33.5	13	11



glass cloche

clear glass, handblown, with round handle, for coaster "Solid" items 4734...

item	Ø in cm	height in cm
4850	18.5	31
4851	22.5	37
4852	26	43



glass cloche/wine cooler

clear glass, handblown, reinforced version, with round handle, for coaster "Solid" item 4734.02 (as cloche) and wine cooler stand item 2220.70 (as wine cooler)

item	Ø in cm	height in cm
4848	22.5	26

Borosilicate glass cloches



Cloches made of borosilicate glass are heat resistant, dishwasher-safe and very easy to handle. The main features of this material are a great resistance against heat and changes in temperature as well as a high breaking strength. Each item is manufactured by hand and therefore shaped individually.



coaster/glass insert

clear glass, 4 mm thick, round, edge polished and deburred, with 4 transparent silicone feet

item	Ø in cm	for coaster "Solid" item
5244.17	16.7	4734.01
5244.21	20.7	4734.02
5244.24	24.2	4734.03
5244.28	28.2	4734.04



coaster "Solid"

walnut, food-safe sealed, not dishwasher-safe, stackable, for glass cloche items 4848, 4850, 4851, 4852 and 4880... and glass inserts items 5244....

item	Ø / height in cm	for cloches / inlays
4734.01	23/3	Ø 18.5/16.7 cm
4734.02	27/3	Ø 22.5/20.7 cm
4734.03	30.5/3	Ø 26/24.2 cm
4734.04	34.5/3	Ø 30/28.2 cm



glass cloche

borosilicate glass, transparent, handblown, handmade, for coaster "Solid" items 4734...

item	Ø in cm	height in cm
4880.18	18.5	approx. 29-32
4880.22	22.5	approx. 35-38
4880.26	26	approx. 41-44
4880.30	30	approx. 48-51



→ Cutting board "Solid" | p. 132

"Mercato"

The lateral cut-outs are suitable for buffet platters with a max. width of 21 or 34 cm.



Integrated rubber feet guarantee stackability and safe standing.

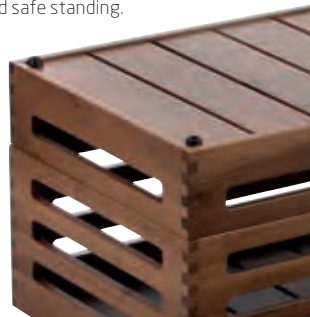

"Mercato"



buffet display/basket "Mercato"

walnut, food-safe sealed, not dishwasher-safe, stackable, with 4 rubber feet (screwed on)

item	l x w x h in cm
4768.08	43x30x8
4768.12	43x30x12
4768.16	43x30x16

The "Mercato" buffet baskets made of walnut are inspired by classic market boxes, but they are superior in many respects. Finger joints in the corners for maximum stability, solid walnut in modern design as well as deliberately chosen dimensions of the heights and lateral cutouts offer numerous advantages. "Mercato" can be converted quickly and flexibly into a buffet display by the use of buffet platters. These platters (from page 56) can simply be laid on or pushed into the lateral cutouts of the baskets (max. width 21 or 34 cm).

The integrated rubber feet ensure safe standing and guarantee the stackability of the baskets. Bread, rolls and pastries remain crisp and fresh longer, as the slotted bottom plates allow sufficient air circulation.

The "Solid" bed tray is a nice addition to this system. Due to its integrated foldable feet, there is no need for displays for elevated positioning. For more information on the bed tray, please see page 299, for the fitting "Solid" breakfast buffet, please check pages 128 onwards.



→ Cutting board and the bridge "Solid" | p. 132



Items made of walnut wood are not dishwasher-safe. Please note enclosed care instructions.



connector piece "Solid"

walnut, food-safe sealed, not dishwasher-safe, for buffet setup of 2 pieces of the tray stand item 4746 one above the other, with 2 boreholes for wall mounting (optional, mounting material not included)

item	l x w x h in cm
4747	46.8x12x54.5



tray stand "Solid"

walnut, food-safe sealed, not dishwasher-safe, removable cover strip, with 6 rubber feet and 8 anti-slip feet on the top side, 2 pieces combinable with connector piece "Solid" item 4747 (for buffet setup of two pieces item 4746 one above the other), for 1 serving tray "Solid" items 4707 or 4740

item	l x w x h in cm
4746	42x51x13.5



tray stand "Solid"

walnut, food-safe sealed, not dishwasher-safe, with 6 rubber feet and 16 anti-slip feet on the top side, for 2 serving trays "Solid" items 4707 and 4740

item	l x w x h in cm
4718	72.5x51x22



Bread and more – attractively presented!

The presentation of bread is not only important at the table, but at the breakfast buffet, too. The variety of baked goods wants to be put in the limelight.

Oblique displays for one or two wooden trays allow for a clear arrangement of various types of bread. With the help of a connector piece, two of these tray displays (item 4746) may be stacked and used on top of each other - the ideal solution for small buffet tables.

A fitting cutting board including a crumb drawer and an exchangeable grate, a cutting board made of end grain wood as well as various bridges (page 132) complete the series and provide the healthy and diversified breakfast with a new look.

Besides the flat bread tray you can also find a deeper version of this tray, which is suited especially for the presentation of rolls, buns, biscuits and pastries. A removable grate provides air circulation, freshly baked buns remain scrumptious longer. Two kinds of divisions for the tray offer space for several miniatures (from page 288) and allow for a flexible use of the system. A cutlery insert for the deep tray as well as an insert for slices of toasted bread round off the range.

Solid wood from the walnut tree, which is one of the most precious and most beautiful types of wood, forms the basis for this series. Both the woods warm brown colours in different shades and its intensive and distinctive grain make every product a unique item.





i Glass insert 1668.03 please order separately.

→ Tray stand "Solid" | p. 137

→ Suitable miniatures made of glass and china | from p. 288



4740 + 4745



glass platter

special hardened safety glass, 4 mm thick, rectangular, rounded edges, polished rim, dishwasher-safe, rubber feet included (adhesive), underside scratch-proof, for serving tray "Solid" items 4707 and 4740

item	version	l x w in cm
1668.03	black glass	50x34

tray insert "Solid"

walnut, food-safe sealed, not dishwasher-safe, divides the tray into 8 sections (length: 31.9 cm, width: 5.4 cm each), for serving trays "Solid" items 4707 and 4740 and miniatures with a max. width / Ø of 5 cm

item	l x w x h in cm
4742	50x34x2.9

tray insert "Solid"

walnut, food-safe sealed, not dishwasher-safe, divides the tray into 6 sections (length: 31.9 cm, width: 7.5 cm each), for serving trays "Solid" items 4707 and 4740 and miniatures with a max. width / Ø of 7 cm

item	l x w x h in cm
4743	50x34x2.9

serving tray "Solid"

walnut, flat, food-safe sealed, not dishwasher-safe, with 2 recessed grips, with 4 rubber feet

item	l x w x h in cm	l x w (inside) in cm
4707	53x37x4	50.2x34.2

serving tray "Solid"

walnut, deep, food-safe sealed, not dishwasher-safe, 2 recessed grips, with 4 rubber feet

item	l x w x h in cm	l x w (inside) in cm
4740	53x37x10	50.2x34.2

grate insert "Solid"

walnut, food-safe sealed, not dishwasher-safe, with 9 rubber feet (6 mm high), for serving trays "Solid" items 4707 and 4740

item	l x w x h in cm
4741	49.8x33.8x2

cutlery insert "Solid"

walnut, food-safe sealed, not dishwasher-safe, divides the tray into 4 sections (length: 24.9 cm, width: 11.2 cm each), for serving tray "Solid" item 4740 (for cutlery with a max. length of 24.7 cm)

item	l x w x h in cm
4744	50x27x7

tray insert "Solid"

walnut, food-safe sealed, not dishwasher-safe, divides the tray into 4 sections (length: 32 cm, width: 3x 13 cm and 1x 8 cm), for serving tray "Solid" item 4740

item	l x w x h in cm
4745	50x34x7



4707 + 1668.03



4707 + 4742



4707 + 4743



4707 + 4741



4740 + 4741



4740 + 4744



4740 + 4743



4740 + 1668.03



Please note:

The changeable grate of the "Solid" cutting board has been constructed to protrude slightly from the cutting board to protect its rim.



replacement grate "Solid"

walnut, oiled, for bread cutting board "Solid" item 4733

item	l x w x h in cm
4733.R	39.8x24.3x1.8

cutting board "Solid"

walnut (end grain), oiled, stackable, not dishwasher-safe, with juice rim/groove to place cloches

item	Ø in cm	height in cm
4776	29	5

bridge "Solid"

walnut, food-safe sealed, not dishwasher-safe, with 3 tapered holes (Ø 1.2 cm top side/1.1 cm underside), with 4 rubber feet, for bowls with max. Ø 15 cm

item	l x w x h in cm
4731	54x17x12



bowl "Shine"

stainless steel 18/10, outside polished, double-walled, round/oblique, Ø 15.7 cm, 6.7 / 8.8 cm high, 0.5 l content, for bridge "Solid" item 4731

item	colour inside
2260.16	satined (dishwasher-safe)

bread cutting board "Solid"

walnut, oiled, not dishwasher-safe, with 4 rubber feet, with walnut grate (39.8 cm long, 24.3 cm wide, 1.8 cm high, exchangeable) and 18/10 stainless steel drawer for crumbs (with magnetic fixing)

item	l x w x h in cm
4733	48x32.5x4.3

cutting board "Solid"

walnut (end grain), oiled, not dishwasher-safe, with 4 rubber feet (screwed on)

item	l x w x h in cm
4732.PB	48x32.5x4.8



bridge "Solid"

walnut, food-safe sealed, not dishwasher-safe, with 4 rubber feet

item	l x w x h in cm
4730	54x17x16



Show cooking is a popular trend!

Whether using it for catering, at events or at the hotels own buffet, the solid wood cutting boards by Zieher are pleasing eyecatchers and offer high functionality. The matching bridges can be equipped with bowls, putting everything tidily within reach for the work behind the buffet.

The dimensions of both cutting boards and bridges have been chosen in such a way, that exactly two boards and two bridges would fit into a regular transportation box. This is extremely useful when it comes to storing the items for their daily use and transportation for catering purposes.

More items from this series can be found on pages 255 to 265.



Please note:

The Zieher cutting boards are oiled. The use of the cutting boards naturally wears down their surfaces. In case of smaller abrasions, rub down the surface with a thin layer of vegetable oil or special care oil for wooden kitchen countertops to refresh the surface. The removable grate for the bread cutting board (item 4733) can be ordered separately as a spare part (item 4733.R). The above mentioned items are not dishwasher-safe. Please check the enclosed leaflet for detailed care instructions.



Stackable in all usual transport boxes with a size of 60 cm x 40 cm (e. g. meat box, height approx. 20 cm)

"Connect!"



The cutting boards are pluggable and can be connected with each other.



Please note:

Please note the care instructions: not dishwasher-safe, do not immerse in water!



cutting/snack board "Connect!"

walnut, oiled, not dishwasher-safe, pluggable, with handle, with 4 rubber feet

item	l x w x h in cm	length incl. handle
4774.31PB	26.5x20x2.3	31



cutting/snack board "Connect!"

walnut, oiled, not dishwasher-safe, pluggable, with handle, with 4 rubber feet

item	l x w x h in cm	length incl. handle
4775.44PB	40x16x2.3	44.5

Serving platters made of walnut!

Sublime in their appearance, unadorned in design, practical by compact formats and highly functional in combination - the solid wood boards of the series "Connect!" convince as a snack board, serving and cutting board or as a presentation platter, created by the combination of several elements. "Connect!" is an extremely versatile tool for everyday use. All information are available on page 259.

"Solid"

These classy service platters take effect by their exceptional shape and the stylish combination of oiled walnut wood and slate-grey ceramics.

Available in two different sizes for just one or more persons, single courses right up to mixed arrangements - so-called "sharing plates" - can be staged appealingly. For bigger buffet setups, several plates can be arranged to save space and thus provide an extraordinary structuring of the buffet areas. The pentagonal design allows numerous arrangements and enables beautiful presentation areas on the buffet.

The projecting handle permits an easy removal of the insert and thus allows an uncomplicated cleaning of the thin but very robust ceramic.



serving tray "Solid"

walnut, oiled, not dishwasher-safe, with changeable insert made of black coloured ceramic

item	l x w in cm
4780.46	46.5x23
4780.67	67.5x33



insert/platter

coloured ceramic, 6 mm thick, black, dishwasher-safe

item	l x w in cm
4780.46S	39x19.5
4780.67S	59x29



→ All information about the serving trays and suitable inserts | p. 258



buffet display "Solid"

walnut, food-safe sealed, not dishwasher-safe, bottom side open, can be used as a stand or as a container

item	l x w x h in cm	PU
4767.12	12x12x12	2 pcs
4767.24	12x12x24	2 pcs



card holder

walnut, varnished, slot 2 mm wide

item	l x w x h in cm	PU
4726	8x3x3	4 pcs



bread basket "Solid"

walnut, food-safe sealed, not dishwasher-safe, boat-shaped

item	l x w x h in cm
4770.24	24.5x12x5





→ All information about the serving tray “Solid” item 4769 | p. 256



serving tray “Solid”

walnut, food-safe sealed, not dishwasher-safe, stackable, 2 compartments: 30 cm x 30 cm and 30 cm x 8 cm (for cutlery or china/glass bowls), with 4 rubber feet

item	l x w x h in cm
4769	41.7x32.5x6.7

Both the Roomservice tray and the bed tray allow you to eat directly from it due to the recessed longside.

The retractable feet of the bed tray have been constructed in a very stable way and are securely kept in position by integrated magnets when folded in. The tray also cuts a good figure on the buffet. The positioning feet make it possible to dispense with the use of displays for heightened placing. A speedy setup and flexible handling facilitate daily operations.



bed tray “Solid”

walnut, food-safe sealed, not dishwasher-safe, stackable, with feet, 2 handles, recessed on one side of the rim

item	l x w x h in cm (closed)	l x w x h in cm (set up)
4773	60x40x6.5	74x40x31

The shapely stand always provides the appropriate possibility to set up the “Solid” room service tray (item 4735) in the hotel room, but also in the restaurant. Combined with trays and glass platters in sizes starting from 55 x 36 cm, it easily and flexibly creates new spaces at a comfortable height. Thus, it is predestined for the use at the buffet and during coffee breaks in the congress and convention business. The massive frame made of walnut wood harmonises perfectly with other buffet items of the series (from page 122) and can be combined with them very well. Rubber feet on the top prevent the shifting of platters and trays, felt gliders at the base protect the parquet flooring and ensure safe standing.



tray stand/side table “Solid”

walnut, with black nylon ribbons, anti-slip rubber feet on top and felt gliders at the bottom, for trays and buffet platters in sizes starting from 55 cm x 36 cm, 102 cm high (folded up), 87 cm high (opened)

item	l x w x h in cm (opened)
4748	54.5x36x87



4748 + 4735



room service tray “Solid”

walnut, food-safe sealed, not dishwasher-safe, stackable, recessed on one side of the rim, with 2 handles, with 4 rubber feet, suitable for tray stand “Solid” item 4748

item	l x w x h in cm
4735	60x40x5.4



The rubber feet at the base are set back from the rim to enable the transport on a tray trolley in 1/1 EN-format (60 cm x 40 cm).

"Solid"



Catering



Please note:

The cutlery boxes item 4720 (wood) and 4594 (melamine) are stackable in all commercial transport boxes in format 60 cm x 40 cm.

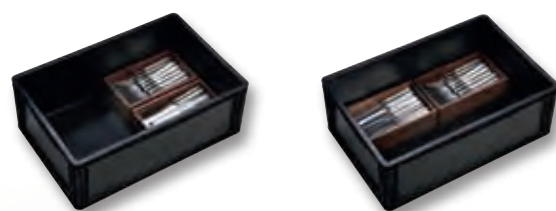

cutlery box "Solid"

walnut, food-safe sealed, not dishwasher-safe, with acrylic glass lid, with 4 rubber feet, for cutlery with a length of up to 24.3 cm

item	l x w x h in cm
4720	26.5x16.2x8



Grooves to let the water run off



4591 + 4588



Please note:

Cleaning in the dishwasher is possible up to a maximum water temperature of 70 degrees.

cutlery box

melamine, black, stackable, surface matt, food-safe, not suitable for microwave and combi steam oven, for cutlery with a length of up to 23.5 cm

item	l x w x h in cm	content in l	PU
4594	26.5x16.2x7.2	2.25	4 pcs

cutlery/napkin box

melamine, black, stackable, surface matt, food-safe, with 4 rubber feet, not suitable for microwave and combi steam oven, for cocktail napkins folded to 1/8

item	l x w x h in cm	content in l	PU
4591	16x6x4.5	0.26	2 pcs

4594 + 4589



"Bento Box"



Please note:

The lid of the Zieher Bento Box is also suitable as a shapely tray.

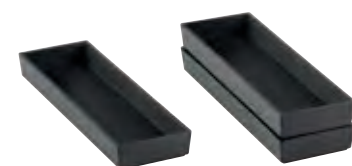

insert/box

melamine, black, surface matt, stackable, food-safe, not suitable for microwave and combi steam oven, up to 4 pieces fit into item 4578

item	l x w x h in cm	PU
4580	29.5x9x3.3	3 pcs



lid/tray

melamine, black, surface matt, stackable, food-safe, not suitable for microwave and combi steam oven, with ventilation slots, suitable for item 4578, also usable as a tray

item	l x w x h in cm
4579	39.5x31.5x4



Available in different colours from 350 sets (box + lid) upon request!



Please note:

Cleaning in the dishwasher is possible up to a maximum water temperature of 70 degrees.



Bento Box

melamine, black, surface matt, stackable, food-safe, not suitable for microwave and combi steam oven, partition for cutlery/napkin/inserts (28 cm x 7.5 cm) or for platters (28 cm x 28 cm)

item	l x w x h in cm
4578	39x30.5x8.5

"Bento Box"

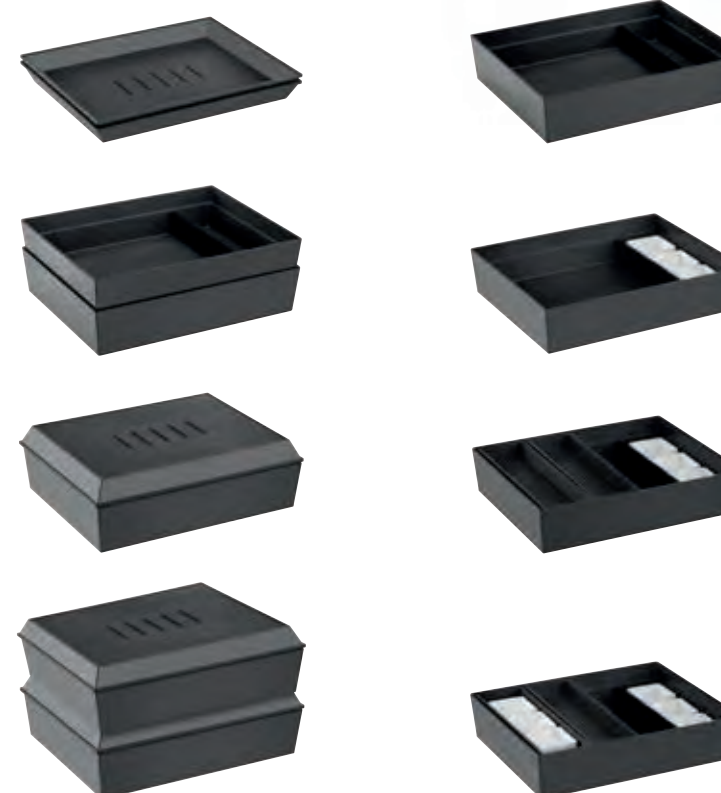

"Bento Box" – flexible mobility

Matt black melamine, modern design and subtle contrasts, created by different surface structures, form the perfect setting for individual creations and popular classics such as burgers, club sandwiches or salads.

The box is divided into a main compartment for plates up to a diameter of 28 cm and a narrow side compartment for cutlery and napkin or miniatures made of glass and porcelain.

Optionally available inserts create additional space for side dishes, sauces or dips, when placed above the cutlery compartment. Up to four of these boxes can be placed in a Bento Box if required, and, with a correspondingly flat content of the main compartment, create a second level for even more flexibility.

The cover has decorative ventilation slots to dissipate steam generated by hot food. This lid can also be used as a tray, whose less finely textured inside has an anti-slip effect.

Box, insert and lid are sold separately and can be combined as desired. All components are stackable. This way, they guarantee a space-saving storage and a comfortable, non-slip transport, even with several dishes at the same time.

→ Suitable inserts made of glass and china (7 cm x 7 cm) | p. 289



Advantages of melamine:

- food-safe
- odourless
- easy-care
- modern design with matt black surface



Please note:

Items made of melamine are not to be used for cooking in microwave and combi steam oven!

Cleaning in the dishwasher is possible up to a maximum water temperature of 70 degrees.



→ Spoon rest made of melamine | p. 146
→ Suitable spoons and skewers | p. 248

Handwashing recommended



GN tray

melamine, black, surface matt, food-safe, not suitable for microwave and combi steam oven

item	l x w x h in cm	GN	PU
4587	32.5x17.6x1.8	1/3	2 pcs
4588	32.5x26.5x1.8	1/2	2 pcs
4589	53x32.5x1.8	1/1	2 pcs



base tray "Modul"

melamine, black, surface matt, food-safe, not suitable for microwave and combi steam oven

item	l x w x h in cm	PU
4581	53x28x1.8	2 pcs
4582	72.5x28x1.8	2 pcs
4583	95.5x28x1.8	2 pcs

The advantages of melamine are particularly evident in daily catering use.

The matt black surface of the Zieher melamine items generates a superb contrast to glass and porcelain and impresses by its pleasant haptics. The trays are available in common GN formats and in three slim rectangular formats.

Different boxes made of the same material can be arranged in a variety of combinations on all melamine trays and thus offer enormous potential for a use at the Flying Buffet, in catering, at the bar or at the breakfast buffet. A selection of suitable combinations is available on the following pages.

The sturdy containers can also be used as plain elevations for platters and trays. Without additional efforts in procuring material, it is possible to arrange varied buffet presentations quickly and easily.

The bridges and spoon rests (page 146) can be used on all trays, non-skid rubber feet on the bottom side facilitate the service enormously.



bowl/box

melamine, black, surface matt, food-safe, not suitable for microwave and combi steam oven

item	l x w x h in cm	content in l	PU
4598.09	9x6.3x4.5	0.25	6 pcs
4598.13	12.8x9x4.5	0.35	4 pcs

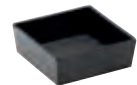

bowl/box

melamine, black, surface matt, food-safe, not suitable for microwave and combi steam oven

item	l x w x h in cm	content in l	PU
4599.13	12.8x12.8x4.5	0.51	4 pcs



insert/box

melamine, black, surface matt, stackable, food-safe, not suitable for microwave and combi steam oven, up to 4 pieces fit into item 4578

item	l x w x h in cm	content in l	PU
4580	29.5x9x3.3	0.55	3 pcs



cutlery box

melamine, black, stackable, surface matt, food-safe, not suitable for microwave and combi steam oven, for cutlery with a length of up to 23.5 cm

item	l x w x h in cm	content in l	PU
4594	26.5x16.2x7.2	2.25	4 pcs



cutlery/napkin box

melamine, black, stackable, surface matt, food-safe, with 4 rubber feet, not suitable for microwave and combi steam oven, for cocktail napkins folded to 1/8

item	l x w x h in cm	content in l	PU
4591	16x6x4.5	0.26	2 pcs



tray

melamine, black, surface matt, food-safe, not suitable for microwave and combi steam oven

item	l x w x h in cm	PU
4586	25.2x13.2x1.8	2 pcs



4589 + 4594

The boxes can be arranged in a variety of combinations on all melamine trays and thus offer enormous potential for a use at the Flying Buffet, in catering, at the bar or at the breakfast buffet.

A small range of possible combinations is shown here, all melamine trays and inserts shown on this double-page are available on the previous pages.



4589 + 4594



4589 + 4598.13 + 4599.13



4589 + 4598.13 + 4599.13



4589 + 4598.13



4591 + 4588



4587 + 4599.13



4588 + 4598.13



4588 + 4591



4587 + 4598.13



4588 + 4598.13 + 4599.13



4588 + 4598.09



4586 + 4591



4586 + 4598.09



4587 + 4598.09



4583 + 4598.09 + 4598.13



4583 + 4598.09 + 4598.13



4582 + 4598.13



4582 + 4598.09 + 4598.13



4582 + 4598.09 + 4598.13



4581 + 4598.13



4581 + 4598.09 + 4598.13

Please note:

Items made of melamine are not to be used for cooking in microwave and combi steam oven!

Cleaning in the dishwasher is possible up to a maximum water temperature of 70 degrees.



Individualisation as of 300 pieces upon request.



→ Party spoons item 1938.01 | p. 248



Please note:

Cleaning in the dishwasher is possible up to a maximum water temperature of 70 degrees.



bridge "Modul"

melamine, black, surface matt, food-safe, not suitable for microwave and combi steam oven, 5 graded sockets (Ø top 5 cm, Ø bottom 2.5 cm), for several glass items (5257, 5405,...), with 4 rubber feet (black)

item	l x w x h in cm	PU
4584	41.5x7.7x6	2 pcs

spoon rest "Modul"

melamine, black, surface matt, food-safe, not suitable for microwave and combi steam oven, with 4 rubber feet (black)

item	l x w x h in cm	PU
4585	20x5x4	2 pcs

2/8 GN tray

melamine, black, surface matt, food-safe, not suitable for microwave and combi steam oven, with 3 round sockets (Ø 5.5 cm / 8.2 cm)

item	l x w x h in cm	PU
4590	32.5x13.2x1.8	2 pcs

2/8 GN tray

melamine, black, surface matt, food-safe, not suitable for microwave and combi steam oven, with 3 oval sockets (diagonal), for small bowls items 4081.12 (china) and 5444 (glass)

item	l x w x h in cm	PU
4593	32.5x13.2x1.8	2 pcs



4593 + 5444



glass bowl

clear glass, oval

item	l x w x h in cm	content in l	PU
5444	12.5x7x4	0.08	6 pcs



bowl

china, white, oval

item	l x w x h in cm	content in l	PU
4081.12	12.5x7.5x4	0.1	12 pcs



→ Inserts made of glass and china, suitable for item 4590 | p. 291



→ More trays made of walnut | p. 130-137



servicing tray "Solid"

walnut, food-safe sealed, not dishwasher-safe, stackable, 2 compartments: 30 cm x 30 cm and 30 cm x 8 cm (for cutlery or china/glass bowls), with 4 rubber feet

item	l x w x h in cm
4769	41.7x32.5x6.7



cutlery box "Solid"

walnut, food-safe sealed, not dishwasher-safe, with acrylic glass lid, with 4 rubber feet, for cutlery with a length of up to 24.3 cm

item	l x w x h in cm
4720	26.5x16.2x8



→ All information about the serving tray "Solid" | p. 256



Please note:

The cutlery boxes item 4720 (wood) and 4594 (melamine) are stackable in all commercial transport boxes in format 60 cm x 40 cm (e.g. meat box, height 20 cm).



"Modul" – walnut

Solid wood from the walnut tree, which is one of the most precious and most beautiful types of wood, forms the basis for this series. Both the wood's warm brown colours in different shades and its distinctive grain make every product a unique item. The high-quality workmanship in combination with the food-safe sealing guarantees long durability, even in everyday use.



→ Party spoon 1938.01 | p. 152



→ Suitable inserts for bridge "Modul" | p. 154



The finger-groove on the bottom side of the tray guarantees safe and simple handling

Please note:



Items made of walnut wood are not dishwasher-safe, do not immerse in water!



bridge "Modul"

walnut, food-safe sealed, not dishwasher-safe, with 5 graded sockets (Ø top 5 cm, Ø bottom 2.5 cm), with 4 rubber feet

item	l x w x h in cm
4724	42.5x9x6.5

buffet display "Solid"

walnut, food-safe sealed, not dishwasher-safe, bottom side open, can be used as a stand or as a container

item	l x w x h in cm	PU
476712	12x12x12	2 pcs
476724	12x12x24	2 pcs



spoon rest "Modul"

walnut, food-safe sealed, not dishwasher-safe, with 4 rubber feet

item	l x w x h in cm
4725	21x3.2x3.8



base tray "Modul"

walnut, food-safe sealed, not dishwasher-safe, stackable

item	l x w x h in cm
4721	47.5x25.5x3.1
4722	70x25.5x3.1
4723	92.5x25.5x3.1

"Modul" – walnut

"Modul" is a flexible product ready for "Flying Buffet" service – and therefore ideally suited for the use in the catering area. The slim, oblong format of the base tray, which is available in three sizes, renders the often cumbersome service at crowded standing receptions barrier-free and uncomplicated. The trays can be variably fitted with glass or porcelain parts, a bridge for glasses or a spoon bench for 4 spoons. When using two spoon benches, 4 long skewers can be placed safely on top.

"Modul" is manufactured from solid walnut wood or from melamine in a modern matt-black design.



→ More items made of walnut | p. 122-138 and 254-265



→ Plate “Modul” 4383 | p. 152

→ Skewer 1939.01 | p. 153



i The grooves on the underside of the tray allow water to drain away.



The advantages of melamine are manifold. It is dishwasher-safe and food-safe, which becomes evident in daily catering use!

The smallest tray is 53 cm long and is therefore partially compatible with existing GN-systems. All trays are stackable.

Besides the merely technical properties, the flat black trays differ from the variant made of walnut by their modest design and modern appearance.

Please note:

Cleaning in the dishwasher is possible up to a maximum water temperature of 70 degrees Celsius.

→ Melamine trays in GN-dimensions | p. 143
→ Cutlery/napkin box | p. 142



bridge “Modul”

melamine, black, surface matt, food-safe, not suitable for microwave and combi steam oven, 5 graded sockets (Ø top 5 cm, Ø bottom 2.5 cm), for several glass items (5257, 5405,...), with 4 rubber feet (black)

item	l x w x h in cm	PU
4584	41.5x77x6	2 pcs



spoon rest “Modul”

melamine, black, surface matt, food-safe, not suitable for microwave and combi steam oven, with 4 rubber feet (black)

item	l x w x h in cm	PU
4585	20x5x4	2 pcs



← 53 cm →

base tray “Modul”

melamine, black, surface matt, food-safe, not suitable for microwave and combi steam oven

item	l x w x h in cm	PU
4581	53x28x1.8	2 pcs
4582	72.5x28x1.8	2 pcs
4583	95.5x28x1.8	2 pcs

- modern design with matt-black surface
- food-safe
- odourless
- easy-care



→ Buffet stands “Lightning Buffet” | p. 52

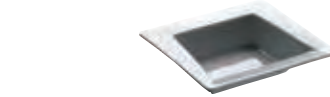

bowl "Modul"
china, white, square, deep, for base trays "Modul" made of walnut and melamine

item	l x w in cm	content in l	PU
4381	11x11	0.07	12 pcs

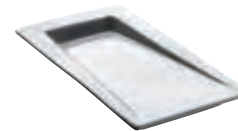

plate "Modul"
china, white, rectangular, flat, for base trays "Modul" made of walnut and melamine

item	l x w in cm	PU
4383	22x11	12 pcs

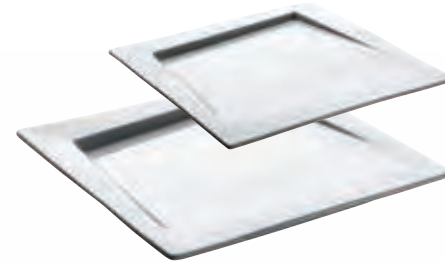
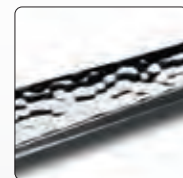

plate "Modul"
china, white, square, flat, item 4385.22 fits base trays "Modul" made of walnut and melamine

item	l x w in cm	PU
4385.22	22x22	6 pcs
4385.27	27x27	4 pcs



party spoon
stainless steel 18/10, 4,3 mm thick, heavy quality, 21 cm long

item	version
1938.01	hammered

"Modul" – variations



amuse gueule/tapas spoon
china, white

item	l x w x h in cm	PU
4260.01	13x4x3	12 pcs



spoon rest "Modul"
melamine, black, surface matt, food-safe, not suitable for microwave and combi steam oven, with 4 rubber feet (black)

item	l x w x h in cm	PU
4585	20x5x4	2 pcs



skewer
stainless steel 18/10, polished, 24 cm long

item	version	PU
1939.01	Moon	12 pcs



cutlery/napkin box
melamine, black, stackable, surface matt, food-safe, with 4 rubber feet, not suitable for microwave and combi steam oven, for cocktail napkins folded to 1/8

item	l x w x h in cm	content in l	PU
4591	16x6x4.5	0.26	2 pcs



"Modul" – variations



The "Modul" base trays made of walnut and melamine combine well with Zieher items from the same series and beyond.



small bowl

china, white, square

item	l x w x h in cm	content in l	PU
3853	7x7x2	0.05	12 pcs



small bowl

china, square, 4.9 cm long, 4.9 cm wide, 4.5 cm high, 0.05 l content

item	version	PU
3845	china	4 pcs
5254	clear glass	4 pcs



glass bowl

borosilicate glass, flat

item	Ø / height in cm	content in l	PU
4910	10.5/2.5	0.18	12 pcs



glass miniature

clear glass, for bridges "Modul" items 4584 and 4724

item	Ø / height in cm	content in l	PU
5257	7/10	0.08	12 pcs



glass miniature

clear glass, wavy rim, base: 0.07 l content, top part: 0.04 l content, for bridge "Modul" items 4584 and 4724

item	version	Ø / height in cm	PU
5423.01	base	6.5/5.5	12 pcs
5423.02	top	6.3/4.5	12 pcs



glass miniature

clear glass, for bridges "Modul" items 4584 and 4724

item	Ø / height in cm	content in l	PU
5405	5/8.6	0.1	6 pcs



test tube

test tube with flanged rim and round bottom, for holder for test tube item 4680.S and cork item 1501

item	Ø / height in cm	content in l	PU
4032.G	2/15	0.04	24 pcs

cork

for test tube item 4032.G

item	Ø in cm	length in cm	PU
1501	2/1.7	2.6	24 pcs



holder for test tubes

silicone, Ø 4.6 cm, 2.7 cm high, with grooves on the inside for easy insertion of glass tubes, for test tube item 4032.G

item	colour	PU
4680.S	black	6 pcs

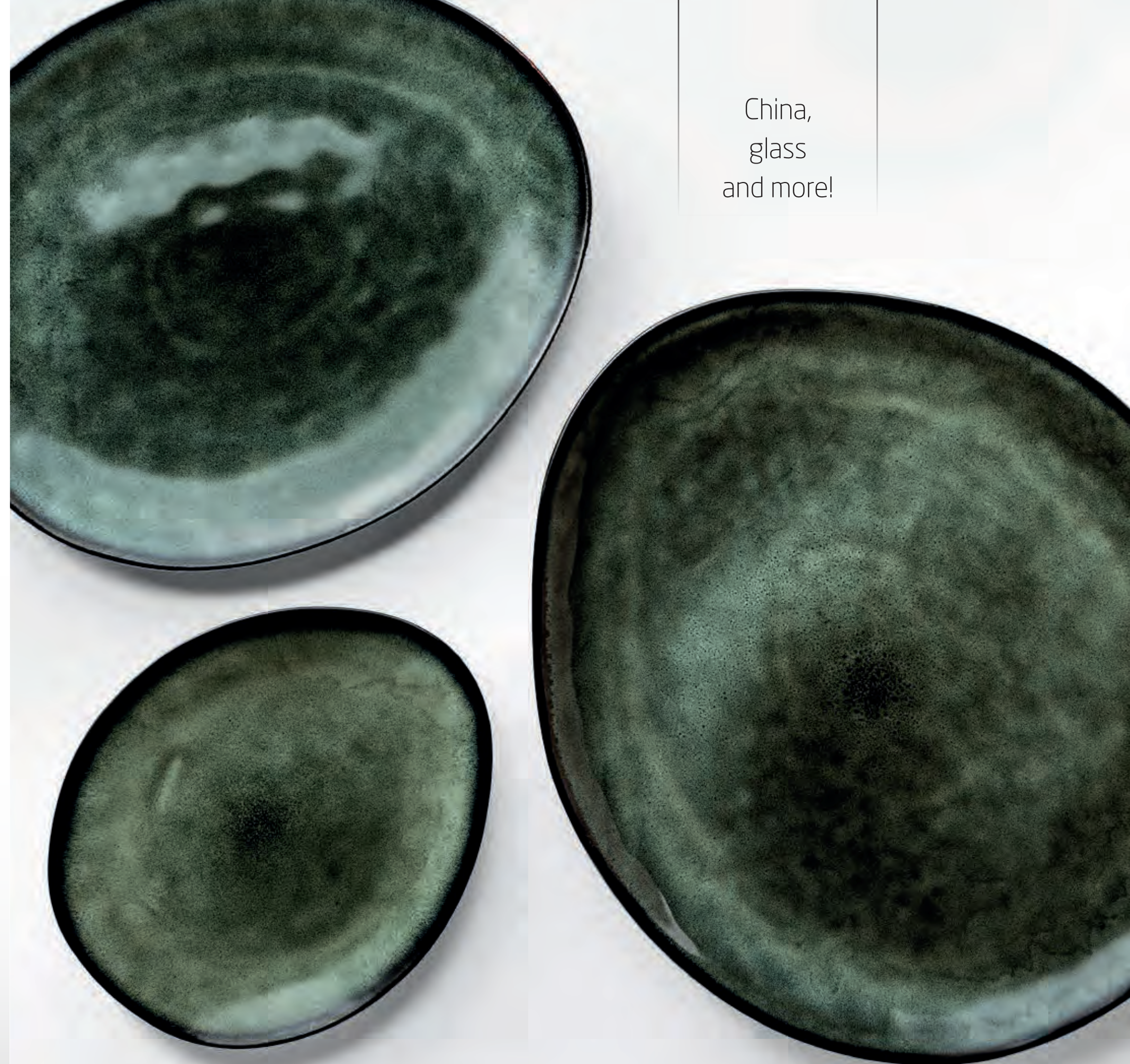

China,
glass
and more!



→ Buffet displays "Sagano" | p. 18



plate "Bosque"

stoneware, green, glossy glazed (reactive glaze), flat, organically shaped

item	l x w in cm	PU
4544.20	approx. 20x17	6 pcs
4544.28	approx. 28.5x24	4 pcs
4544.34	approx. 34x29.5	2 pcs



bowl "Bosque"

stoneware, green, glossy glazed (reactive glaze), organically shaped

item	l x w x h in cm	content in l	PU
4545.10	approx. 10x8x6	approx. 0.1	4 pcs
4545.16	approx. 16x12x9	approx. 0.5	6 pcs
4545.21	approx. 20.5x17x6	approx. 0.8	4 pcs
4545.24	approx. 24x18.5x7	approx. 1.2	4 pcs

A breeze of enchanted forest

The imperfection and individuality of handmade ceramics convince, opposite to the standardised results of industrial manufactured bulk goods, by its very charming and natural flair.

It's only the used reactive glaze that awards the organically shaped plates and bowls of the ceramic series "Bosque" their very special charm. These effect glazes react during the firing process with special ingredients and thus create fascinating patterns, which are basically similar but never identical. They emphasise the handmade character of the crockery and make each piece unique.

With "Bosque", a play of colours of different shades of green, blue and grey is created in fascinating gradients and effects that exude an elegant vibrancy and a festive mood.

NEW

"Ombra"



The small series "Ombra" captivates with its irregular decor. The applied colour is embedded in the glass, making it dishwasher-safe and highly durable. Matching buffet plates in the same design allow for harmonious buffet arrangements, especially when combined with the plates and bowls from the "Ombra" series.

You can find these plates on page 57.



→ buffet displays "Époques" | p. 12-15



glass platter "Ombra"
glass, 4 mm thick, clear, black decor, rectangular, structured, dishwasher-safe

item	l x w in cm	PU
511726	26x15	6 pcs
511731	31.5x16.5	6 pcs



glass plate "Ombra"
glass, 4 mm thick, clear, black decor, round, structured, dishwasher-safe

item	Ø in cm	PU
511619	19.5	6 pcs
511624	24.5	6 pcs



glass bowl "Ombra"
glass, 4 mm thick, clear, black decor, round, structured, dishwasher-safe

item	Ø / height in cm	PU
511522	22/5	6 pcs
511525	25/6	6 pcs

"Ombra"

NEW





→ "DryPod" display | p. 273



glass plate "Gelo"
glass, bottom satined, round

item	Ø in cm	PU
5184.14	14	12 pcs
5184.21	21	6 pcs
5184.25	25	6 pcs
5184.30	30	4 pcs



glass bowl "Gelo"
glass, inside structured, outside satined, round

item	Ø / height in cm	content in l	PU
5185.09	9/5	0.12	6 pcs
5185.14	14/4.5	0.35	12 pcs
5185.21	21/6	1.0	6 pcs
5185.27	27/6.5	2.0	6 pcs



The glass plates and bowls of the "Gelo" series set frosty accents and convey a high valence on the set table by their satined surface and robust style. The bowls, which feature a slight structure on the inside, harmonise very well with the smooth surface of the organically shaped plates. All items of this series are made of extra white special glass which, compared to standard glass, contains a significantly reduced green component.



Dark accents!

The "Sombre" series combines the robustness of porcelain with the individual charm of unique pieces made of ceramic.

Particularly resistant hard-paste porcelain enables the production of comparatively thin and filigree parts, which are provided with a matt black glaze.

The deep dark hue of the matt glaze deliberately focuses on decent irregularities and puts the served dishes into the centre of attention. The organic shape creates a subtle tension. It fits into any environment without losing its individuality.



plate "Sombre"

china, matt black, round, flat, organic shape

item	Ø in cm	PU
3967.20S	20	12 pcs
3967.25S	25	12 pcs
3967.30S	30	6 pcs



plate "Sombre"

china, matt black, round, deep, organic shape

item	Ø / height in cm	PU
3968.20S	20/4	12 pcs



bowl "Sombre"

china, matt black, round, organic shape

item	Ø / height in cm	content in l	PU
3969.15S	15/4.5	0.3	12 pcs



Please note:

Due to the special glaze, irregularities such as running marks or inclusions can appear on the underside of the items. These deliberately contribute to the organic, rustic charm of the items and are unavoidable.



"Bolla"



The reluctant design and plain geometry of these plates result in a perfect basis for the modern staging of premium dishes.

The rampant elevated rim creates sufficient space, the subtle structure of the almost pure white glass also optically forms the frame for extraordinary dishes of the haute cuisine.



coup plate "Bolla"
glass, structured, round

item	Ø in cm	PU
5186.14	13.5	12 pcs
5186.18	17	6 pcs
5186.22	21.5	6 pcs
5186.26	25	6 pcs

"Bolla"





→ Etageres "DressCoat" | p. 94



All items are produced in centrifugal casting. Besides the individual decor, this production method entails a slight variation of size, strength and shape, also some air inclusions are possible. That's exactly what awards these unique pieces their special charm.



glass plate "Unique"

glass, white marbled, bot tom satined, round

item	Ø in cm	PU
5178.16	16.5	6 pcs
5178.21	21	6 pcs
5178.28	28	6 pcs
5178.32	32	3 pcs



glass bowl "Unique"

glass, white marbled, outside satined, round

item	Ø / height in cm	content in l	PU
5180.10	10/6	approx. 0.2	6 pcs
5180.15	14.5/7.5	approx. 0.65	6 pcs

glass bowl "Unique"

glass, white marbled, outside satined, round

item	Ø / height in cm	content in l	PU
5182.16	16/5	approx. 0.67	6 pcs
5182.21	21/8	approx. 2.0	4 pcs
5182.27	26.5/8	approx. 2.75	4 pcs



The plates and bowls of the "Unique" series are made of clear glass, which is awarded an inimitable character by adding white glass components. This creates individual streaks and swirls, which assemble to highly exciting patterns. The underside of the plates as well as the outside of the bowls are blasted, which results in satined optics and pleasant haptics.

"Unique" presents - in shape and decor - a counterpart to the uniform character of industrially manufactured mass products and proves to be as unique as its users.



→ Glasses VISION | p. 204/205



plate/platter "Pulsar"
china, white, Ø inside 10.5 cm, in black gift box

item	Ø in cm
4507.01PB	29.5



plate/platter "Pulsar"
china, black, matt, Ø inside 10.5 cm, in black gift box

item	Ø in cm
4507.02PB	29.5



"Pulsar" – Sparkling impulses!

This gourmet plate is predestined for appetizers, intermediate courses or desserts.

The surface is reminiscent of the playful waves created on a smooth lake after a stones throw. The viewer's gaze purposefully wanders to the centre of the concentric design and this way, the served dishes come straight to the fore.

"Pulsar" is made of high-quality hard porcelain in a surprisingly soft composition and is available glazed in glossy white or in matt black.



Design: Grace Liu, Jian Ping Li



Design: Michael Schwarzmüller



Borosilicate glass in its most beautiful shape!

The primary design element of the series "Cuspis" is a glass ball studded with fine spikes. The cloches with fitting porcelain plateau plates/ bowls are available in three sizes, the inspiration for their shaping was derived from the nut of the oak tree. The unglazed outside of the porcelain bowls is reminiscent of acorn caps.

The bowls can be used on both sides. When used as a plateau plate, the dish moves closer to the guest while the filigree glass cloche protects the presented delicacies and puts them in the limelight at the same time. Used as a bowl, it offers space for gravies, sauces and more.



plateau plate/bowl "Cuspis"

china, white, inside and useable area glazed, outside biscuit, useable on both sides, for cloches items 4940.25 and 4940.10 (bottom side)

item	Ø in cm	height in cm	content in l
4389.25PB	25	2.8	0.8



plateau plate/small bowl "Cuspis"

china, white, inside and useable area (plateau Ø approx. 6 cm/8 cm) glazed, outside biscuit, also useable as a bowl

item	Ø in cm	height in cm	content in l
4389.09	9	3	0.1
4389.11	11.5	3.5	0.18



glass cloche "Cuspis"

borosilicate glass, transparent, handblown, star-shaped ball handle

item	for plate/bowl	Ø in cm	height in cm
4940.08	4389.09	8.5	12.5
4940.10	4389.11	10.5	14.5
4940.25	4389.25PB	25	32.5



If the item is used upside down as a plate, the two rings on the big plates underside can be used on the one hand to separate the prepared dish into different sections and on the other hand different cloches of the "Cuspis" series may also be used with it (4940.10 on the inner ring, 4940.25 on the outer ring).



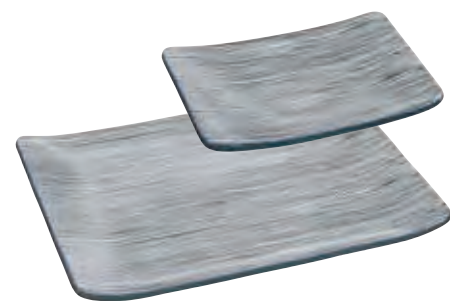
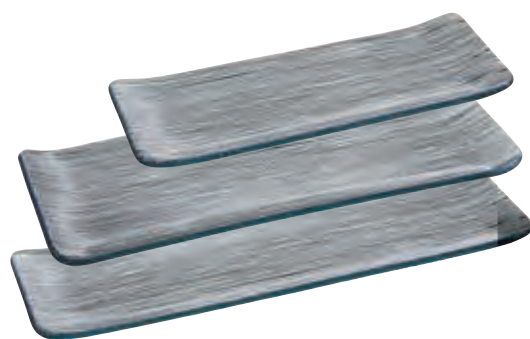

glass platter "Linea"
glass, 6 mm thick, clear, black line decor, rectangular, structured, dishwasher-safe

item	l x w in cm	PU
5031.31	31x12	6 pcs
5031.39	39x16	4 pcs
5031.41	41x12	4 pcs

glass platter "Linea"
glass, 6 mm thick, clear, black line decor, rectangular, structured, dishwasher-safe

item	l x w in cm	PU
5030.20	20x15	6 pcs
5030.31	31x25	4 pcs



small glass bowl "Linea"
glass, 4 mm thick, clear, black line decor, rectangular, structured, dishwasher-safe

item	l x w in cm	PU
5032.09	9x7	12 pcs

Thanks to their contrasting decor the flat glass plates of the "Linea" series provide the ideal foundation for presenting finger food, sushi, and more.

The irregular stripe pattern can also be found on the matching small bowl – the perfect complement for sauces and dips.





→ More buffet bowls made of grey glass | from p. 87



glass platter/plate

glass, 6 mm thick, dark grey, longish, with spiral structure

item	l x w in cm	PU
5169.31	approx. 31x12.5	6 pcs
5169.38	approx. 38x15.5	4 pcs
5169.41	approx. 41.5x12.5	4 pcs



glass plate

glass, 4 mm thick, dark grey, round, with spiral structure

item	Ø in cm	height in cm	PU
5177.20	20	2.5/4.5	6 pcs
5177.25	25	3/6	6 pcs
5177.28	28	3.5/7	4 pcs



glass plate

glass, 8 mm thick, dark grey, oval, with tree bark structure

item	l x w in cm	PU
5700	33x24	3 pcs

glass bowl

glass, 8 mm thick, dark grey, oval, with tree bark structure

item	l x w x h in cm	PU
5701	26.5x19.5x4.5	3 pcs

glass plate

glass, 8 mm thick, dark grey, rectangular, with tree bark structure

item	l x w in cm	PU
5702	40x22	2 pcs





glass tray

glass, deep black, rectangular, for buffet or flying buffet, also functions as a tray

item	l x w x h in cm	version
5142.34	35x35x2	square
5141.50	51x35x2	rectangular

glass platter/plate

glass, 6 mm thick, dark grey, longish, with spiral structure

item	l x w in cm	PU
5169.31	approx. 31x12.5	6 pcs
5169.38	approx. 38x15.5	4 pcs
5169.41	approx. 41.5x12.5	4 pcs

i
Please note
the details about natural slate on page 62.



sushi plate

natural slate, unsealed, approx. 10 mm thick, not dishwasher-safe, with rubber feet

item	l x w x h in cm
2550	25x25x2

charger plate, slate

natural slate, approx. 5 mm thick, unsealed, not dishwasher-safe, with rubber feet

item	version	l x w in cm
2543.30	square	30x30
2544.30	rectangular	30x20

charger plate

special hardened safety glass, 4 mm thick, rectangular, rounded edges, polished rim, dishwasher-safe, rubber feet included (adhesive), underside scratch-proof

item	version	l x w in cm
1670.10	white glass	30x18



→ More platters made of special hardened safety glass | p. 60/61



"Collina" is perfectly suitable for antipasti and delicacies from the patisserie, but a selection of fruits can also be beautifully put in the limelight in the hotel room.

In order to protect the sensitive surfaces of furniture, every plate comes with feet made of rubber, which can be stuck on if needed. The rigorously geometrical structure permits the assembling of several plates, which allows to enlarge the effective area of the platters in both length and width. When looking at the surface from the side, the arrangement has the appearance of a desert landscape formed by the wind.



Design: Wilma Greim

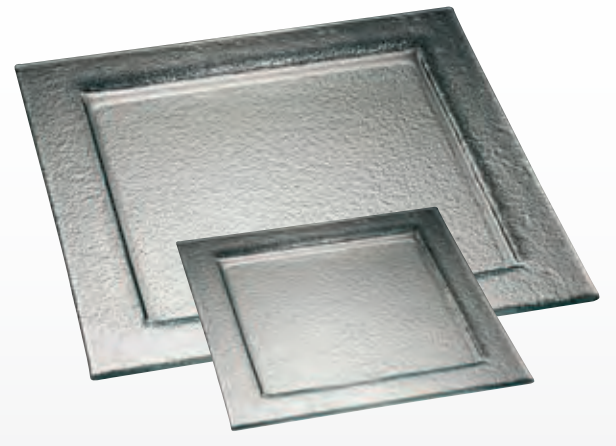

glass platter
glass, structured, transparent, square

item	l x w in cm
5063	30x30
5063.50	50x50

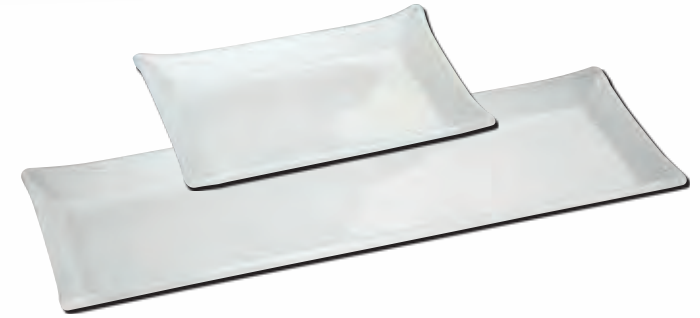

glass tray
glass, satined, rectangular

item	l x w x h in cm
5160.31	31x21x3.5
5160.62	62x21x3.5



glass platter
glass, structured, transparent, rectangular

item	l x w in cm
5064	33x12



glass tray
glass, dark grey, rectangular

item	l x w x h in cm
5161.31	31x21x3.5
5161.62	62x21x3.5

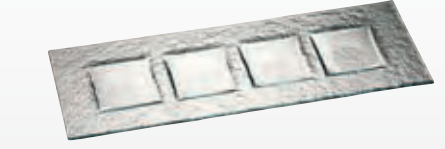

glass platter
glass, structured, transparent, rectangular, four divisions

item	l x w in cm
5084	33x12

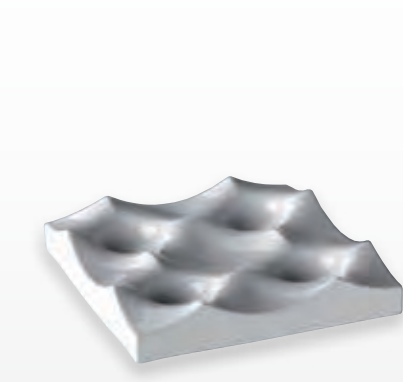

platter "Collina"
china, white, not dishwasher-safe, with 4 deepenings, with 4 rubber feet (enclosed in the pack)

item	l x w x h in cm
4503	24.5x24.5x4.5

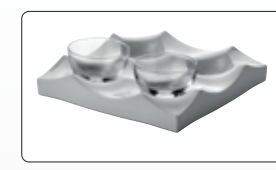

glass bowl/cloche
clear glass, handblown, for platter "Collina" item 4503

item	Ø / height in cm	content in l	PU
5418	9/6	0.2	6 pcs

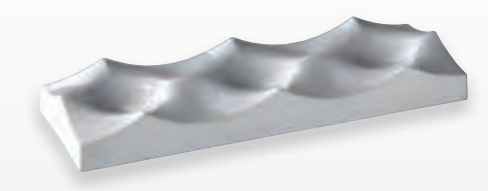

platter "Collina"
china, white, not dishwasher-safe, with 3 deepenings, with 4 rubber feet (enclosed in the pack)

item	l x w x h in cm
4504	36.5x12.5x4.5

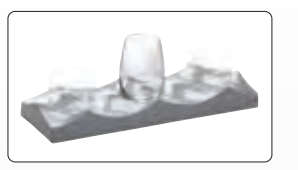

glass
clear glass, for platter "Collina" item 4504

item	Ø / height in cm	content in l	PU
5380	7.5/10.5	0.32	6 pcs



Food: Grzegorz Parczewski
www.facebook.com/grzegorz.parczewski.1

Bedded on glass or china

The organic form of these extraordinary objects offers an ideal presentation area for high-end dishes or for storing various items of everyday life. The glass cushion also cuts a fine figure when used as a soap dish. The larger version made of porcelain sets the scene for every dish in a surprising way and forms an exciting contrast to conventional porcelain shapes.

→ Trays, bridges and spoon benches “Modul” | p. 148



bowl “Modul”

china, white, square, deep, for base trays “Modul” made of walnut and melamine

item	l x w in cm	content in l	PU
4381	11x11	0.07	12 pcs

plate “Modul”

china, white, rectangular, flat, for base trays “Modul” made of walnut and melamine

item	l x w in cm	PU
4383	22x11	12 pcs



plate “Modul”

china, white, square, flat, item 4385.22 fits base trays “Modul” made of walnut and melamine

item	l x w in cm	PU
4385.22	22x22	6 pcs
4385.27	27x27	4 pcs



glass pillow “Donna”

glass, satined, in black gift box

item	l x w x h in cm
5446.01PB	16.5x11x3

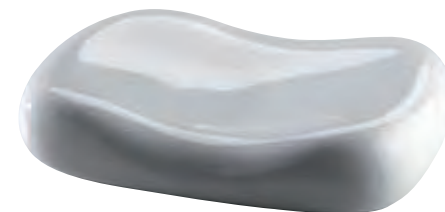

porcelain pillow “Donna”

white, not dishwasher-safe

item	l x w x h in cm
4461.02	33x22x7



Design: Wilma Greim



Design: Nadine Podewski



“DressCoat” was created by the glass and porcelain designer Nadine Podewski. The creation of the plates and bowls respectively is characterised by the apparently free falling drapery of table cloth. This creates a seemingly weightless, almost floating effect. The slightly concave shaped surface offers space for artfully decorated dishes and reliably avoids the sloshing of sauce.

“DressCoat” is available in three different sizes. Besides the main application as a plateau plate, each item can also be used as a bowl. The falling folds add up to an exciting game of shapes – in particular if used as a bowl.



→ Etagere “DressCoat” | p. 277

Food: Pâtisserie Walter (www.patisserie.de)

plateau plate “DressCoat”

china, white, useable area (plateau): Ø 7.5 cm, also useable as a bowl

item	Ø / height in cm	content in l	PU
4386.01	9/4.5	0.1	12 pcs

plateau plate “DressCoat”

white china, useable area (plateau): Ø 15 cm, also useable as a bowl

item	Ø / height in cm	content in l	PU
4387	17/8.5	0.85	3 pcs

plateau plate “DressCoat”

white china, useable area (plateau): Ø 19.5 cm, also useable as a bowl

item	Ø / height in cm	content in l	PU
4388	22/6.5	0.9	3 pcs

“Cave”



“Cave” consists of intricately worked hard porcelain and captures by its soft shaping and the velvety haptics of the unglazed outside. The miniature bowl is predestined for the use at cocktail and hors d'oeuvres receptions or at the flying buffet and can be carried comfortably and perfectly fits in the palm of the hand.

The glass version of the “Cave” bowl is available in two sizes and offers the fitting framework for fruit, nuts and nibbles as well as for tastefully arranged pasta or salad. The soft tint of the grey glass, which is hand-blown in the traditional way, stages the contents of these shapely objects. They remain protected by the shell of glass, the amply dimensioned opening seduces to snap at a chance.



bowl “Cave”

biscuit china, white, inside glazed, opening: Ø approx. 8 cm, in black gift box

item	Ø in cm	height in cm
4375.01PB	approx. 11	7

Stay cool!

Serving chilled food is primarily a technical challenge with certain dishes or intermediate courses. With the two-coloured cooling pads, this necessity can be met in a sophisticated way, also in terms of visual appearance. The wrapper made of black respectively white nylon fabric appears classy and unobtrusive. The pads are filled with gel which remains shapeable, even when frozen and thus allows an adjustment to the tableware used.

→ Information about the utilisation of the cooling pads at the buffet | p. 54



glass bowl “Cave”

dark grey, round, handblown

item	Ø in cm	opening Ø in cm	height in cm
4815.18	approx. 18	approx. 14	approx. 11.5
4815.24	approx. 24	approx. 19	approx. 16.5



cooling pack

nylon, black/white, non-toxic cooling gel

item	l x w in cm
5663.20	20x20

The decanter cooler “On The Rocks” has been exclusively designed for Zieher decanters “Eddy” (4883) and “Star” (4947). The selected grey marble is captivating due to the diverse patterns of its marbling. Each piece is unique and offers the opportunity to decant and simultaneously chill white, rosé, and red wines in a stylish manner.

However, “On The Rocks” also allows for the exceptional presentation and serving of chilled dishes on ice. From oysters or a small serving of caviar to a selection of delightful pralines, the possibilities are virtually limitless.

You can find all information about “On The Rocks” on page 221.



Please note:

Marble is a natural product and the grey marbling can vary significantly, creating a lively and exceptional effect for this natural stone.

Certain foods, especially those containing fruit acids (citric acid), can potentially affect the surface with prolonged contact. Therefore we recommend avoiding direct contact with food. Please clean with a damp cloth and mild cleaning agents only. Not dishwasher safe.



coaster “On The Rocks”

marble, grey patterned, polished, food-safe coating, not dishwasher-safe, for bowl “On The Rocks” item 8057

item	Ø in cm	height in cm
8058	approx. 14	approx. 2

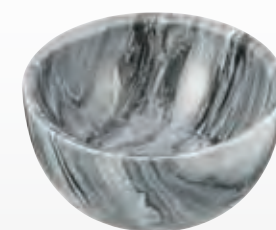

bowl “On The Rocks”

marble, grey patterned, polished, food-safe coating, not dishwasher-safe, for coaster “On The Rocks” item 8058

item	Ø / height in cm	content in l
8057	approx. 20,5/10	approx. 1,4



wine/decanter cooler “On The Rocks”

set consists of:
bowl and saucer made of marble, grey patterned, polished, food-safe sealed, not dishwasher-safe
2 silicone rings for decanter “Eddy” (4884.PB) and decanter “Star” (4948.PB)
 1 set in black gift box

item	Ø / height in cm	content in l	PU
8059.PB	approx. 20,5/11	approx. 1,4 L	1 set (4 parts) 📦



“On The Rocks”

NEW



coup plate "Catering"
china, white, round, flat

item	Ø in cm	PU
3954.21	21	12 pcs



bowl "Catering de Luxe"
china, white

item	Ø / height in cm	content in l	PU
4281.02	19/10	1.0	6 pcs
4281.03	24/12.5	2.0	2 pcs
4281.04	28/14.5	3.5	2 pcs

→ Etagere "Falcon" | p. 114



"oro79" is pure luxury

This exclusive miniseries captivates by its extraordinary surface with its golden mother-of-pearl look. A quartered ball allows serving a variety of food in an entirely new way.

"oro79" offers exceptional service for the most demanding guests!



china ball "oro79"

china, outside golden, 4 parts (3 bowls: 0.5 l / 0.6 l / 0.25 l content + lid), not dishwasher-safe, not suitable for microwave and combi steam oven

item	Ø in cm	height in cm
4563	15.5	15.8



plate "oro79"

china, golden surface, with foot, not dishwasher-safe, not suitable for microwave and combi steam oven

item	l x w x h in cm
4565.35	35x14x1.5

plate "oro79"

china, golden surface, with foot, not dishwasher-safe, not suitable for microwave and combi steam oven

item	l x w x h in cm
4564.26	26.5x26.5x1.5



napkin ring "Reef"

pewter, surface smooth, food-safe, not dishwasher-safe

item	Ø in cm	length in cm	PU
2317	5.5x3.5	7.5	2 pcs

→ "Reef" | p. 70-72



charger plate/glass insert

clear glass, 6 mm thick, round, edge polished and deburred

item	Ø in cm
4999	33



charger plate

special hardened safety glass, 4 mm thick, round, polished rim, dishwasher-safe, rubber feet included (adhesive), underside scratch-proof

item	version	Ø in cm
1669.33	black glass	33
1671.33	white glass	33



→ "DressCoat" | p. 182



cutlery/napkin box "Solid"

walnut, food-safe sealed, not dishwasher-safe, with rubber feet in the lid (soft closure, can be opened to an angle of 90° only), with black felt insert, stainless steel platter with space for an engraving (price and quantity upon request), height with open lid: 15.5 cm

item	l x w x h in cm	size inside in cm
4766	28.8x11.8x6	26x8.7

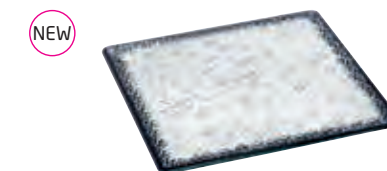

charger plate "Ombra"

glass, 6mm thick, clear, black decor, structured, dishwasher-safe

item	l x w in cm
5114.06	34x34

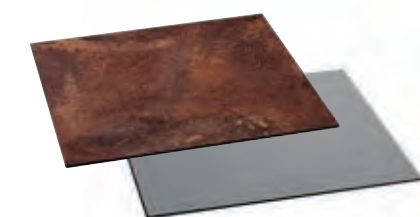

charger plate

laminated plastic, 8 mm thick, black intermediate ply, break-proof, scratch-proof, dishwasher-safe, antistatic, square, deburred edges, rounded corners

item	version	l x w in cm
8007.06	rusted look	34x34
8006.06	dark grey	34x34



charger plate

special hardened safety glass, 4 mm thick, rounded edges, polished rim, dishwasher-safe, rubber feet included (adhesive), underside scratch-proof

item	version	l x w in cm
1668.06	black glass	34x34
1670.10	white glass	30x18

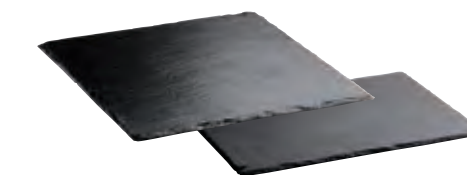

charger plate, slate

natural slate, approx. 5 mm thick, unsealed, not dishwasher-safe, with rubber feet

item	version	l x w in cm
2543.30	square	30x30
2544.30	rectangular	30x20

"Cuspis"



The cloches and porcelain coasters of the series "Cuspis" are inspired by the nuts of the oak tree. The ball-shaped handle at the tip of the cloches allows for an uncomplicated handling of these classy covers. The unglazed outside of the porcelain coasters with its distinctive texture is reminiscent of acorn caps. The coaster can be used on both sides.

If the item is used upside down as a large plate, the two rings on the plates' underside can be used to separate the prepared dish into different sections and the cloches of the "Cuspis" series may also be used with it (4940.10 on the inner ring, 4940.25 on the outer ring).

Design: Michael Schwarzmüller



4389.25PB + 4940.10



glass cloche "Cuspis"

borosilicate glass, transparent, handblown, star-shaped ball handle

item	for plate/bowl	Ø in cm	height in cm
4940.08	4389.09	8.5	12.5
4940.10	4389.11	10.5	14.5
4940.25	4389.25PB	25	32.5



plateau plate/small bowl "Cuspis"

china, white, inside and useable area (plateau Ø approx. 6 cm/8 cm) glazed, outside biscuit, also useable as a bowl

item	Ø in cm	height in cm	content in l
4389.09	9	3	0.1
4389.11	11.5	3.5	0.18



plateau plate/bowl "Cuspis"

china, white, inside and useable area glazed, outside biscuit, useable on both sides, for cloches items 4940.25 and 4940.10 (bottom side)

item	Ø in cm	height in cm	content in l
4389.25PB	25	2.8	0.8

Cloches





→ Wine cooler "Stablo" | p. 110



glass cloche

borosilicate glass, transparent, handblown, handmade, for coaster "Solid" item 4700.01

item	Ø in cm	height in cm
4982.09	9	approx. 14-16



coaster "Solid"

walnut, food-safe sealed, not dishwasher-safe, for glass cloche 4982.09

item	Ø / height in cm	Ø inner circle in cm
4700.01	15.3/2	9.3



coaster "Solid"

walnut, food-safe sealed, not dishwasher-safe, for glass cloche 4982

item	Ø / height in cm	Ø inner circle in cm
4700	22/2	13.3



coaster/glass insert

clear glass, 4 mm thick, round, edge polished and deburred, with 4 transparent silicone feet, for coaster "Solid" item 4700

item	Ø in cm	PU
5244	13	6 pcs



glass cloche

borosilicate glass, transparent, handblown, handmade, for coaster "Solid" items 4734...

item	Ø in cm	height in cm
4880.18	18.5	approx. 29-32
4880.22	22.5	approx. 35-38
4880.26	26	approx. 41-44
4880.30	30	approx. 48-51



coaster "Solid"

walnut, food-safe sealed, not dishwasher-safe, stackable, for glass cloche items 4848, 4850, 4851, 4852 and 4880... and glass inserts items 5244...

item	Ø / height in cm	for cloches / inlays
4734.01	23/3	Ø 18.5/16.7 cm
4734.02	27/3	Ø 22.5/20.7 cm
4734.03	30.5/3	Ø 26/24.2 cm
4734.04	34.5/3	Ø 30/28.2 cm



coaster/glass insert

clear glass, 4 mm thick, round, edge polished and deburred, with 4 transparent silicone feet

item	Ø in cm	for coaster "Solid" item
5244.17	16.7	4734.01
5244.21	20.7	4734.02
5244.24	24.2	4734.03
5244.28	28.2	4734.04



Please note:

The cloche 4848 can also be used as an elegant wine cooler and is therefore manufactured in stronger quality. The result is a slightly higher weight with significantly improved stability. The suitable stand "Mikado" is available on page 225.

→ Wine cooler stand "Mikado" | p. 225



glass cloche/wine cooler

clear glass, handblown, reinforced version, with round handle, for coaster "Solid" item 4734.02 (as cloche) and wine cooler stand item 2220.70 (as wine cooler)

item	Ø in cm	height in cm
4848	22.5	26

coaster/glass insert

clear glass, 4 mm thick, round, edge polished and deburred, with 4 transparent silicone feet

item	Ø in cm	for saucer "Solid" item
5244.21	20.7	4734.02

coaster "Solid"

walnut wood, food-safe sealed, not dishwasher-safe, stackable, for glass cloches item 4848, 4851 and 4880.22 as with glass insert plates trays item 5244.21

item	Ø / height in cm	for cloches / inlays
4734.02	27/3	Ø 22,5/20,7 cm



The cloches on this pages are handblown and, in contrast to our cloches made of borosilicate glass (page 193), are worked by hand from a solid glass drop. Therefore small air inclusions and minor streaks cannot be avoided completely. Each cloche is unique, the result is a harmonic enlivenment of the buffet for an attractive price.



glass cloche

clear glass, handblown, with round handle, for coaster "Solid" items 4734...

item	Ø in cm	height in cm
4850	18.5	31
4851	22.5	37
4852	26	43



coaster/glass insert

clear glass, 4 mm thick, round, edge polished and deburred, with 4 transparent silicone feet

item	Ø in cm	for coaster "Solid" item
5244.17	16.7	4734.01
5244.21	20.7	4734.02
5244.24	24.2	4734.03
5244.28	28.2	4734.04



coaster "Solid"

walnut, food-safe sealed, not dishwasher-safe, stackable, for glass cloche items 4848, 4850, 4851, 4852 and 4880... and glass inserts items 5244....

item	Ø / height in cm	for cloches / inlays
4734.01	23/3	Ø 18.5/16.7 cm
4734.02	27/3	Ø 22.5/20.7 cm
4734.03	30.5/3	Ø 26/24.2 cm
4734.04	34.5/3	Ø 30/28.2 cm



Example of application: Presentation of a premium beer type



charger plate, glass

special hardened safety glass, 4 mm thick, round, edge polished, dishwasher-safe, rubber feet included (adhesive), underside scratch-proof

item	version	Ø in cm
1669.33	black glass	33
1671.33	white glass	33



Please note:

These items are handblown and hand-crafted. Minor size tolerances are normal and inevitable!



pastry/cake stand
clear glass, with foot

item	Ø in cm	Ø stand in cm	height in cm
5349.21	21	10.5	9.5
5349.28	28	13	11.5
5349.33	33.5	13	11

glass cloche

clear glass, for pastry/cake stand items 5349...

item	Ø in cm	height in cm
5350.16	16	13
5350.23	23	16.5
5350.27	27.5	20.5



glass cloche

clear glass, handblown, with handle, for glass stands items 4854... (please order separately)

item	Ø in cm	height in cm
4853	10.5	11.5



glass stand

clear glass, handblown, with round foot (Ø 8 cm) and platform (Ø 11.5 cm), for glass cloche item 4853

item	height in cm
4854.01	13
4854.02	16.5
4854.03	23



Food: Pâtisserie Walter (www.patisserie.de)



Little somethings perfectly staged!

The thick bottom of the hand-blown bowl leads to a blow-up effect when used as a cloche!

glass bowl/cloche

clear glass, handblown, for ring "SelectionA." item 4681.S (please order separately)

item	Ø / height in cm	content in l	PU
5418	9	0.2	6 pcs



ring "SelectionA."

silicone, Ø 8.3 cm, for anti-slip stand of bowl item 5418

item	colour	PU
4681.S	black	6 pcs



wine glasses,
decanter,
bar & more



@trotterwine

The VISION of simplicity

No distinction is made between red wine or white wine glasses in this collection - the glasses are simply theme-based or character-based. The names of the glasses FRESH, STRAIGHT, INTENSE, BALANCED, RICH, NOSTALGIC and SIDE clearly explain what they are used for: You intuitively reach for the glass, which in the best way presents the flavours of the wine you particularly wish to emphasise. If you want a powerful wine to be more harmonious or a touch more lively and fresh, you pick the glass with the designation, that mirrors your requirement best.

VISION

"You have never seen wine like this!"

Silvio Nitzsche, WEIN | KULTUR | BAR Dresden



Follow us on YouTube:
"ZIEHER VISION video"





Filigree craftsmanship

You have never seen wine like this!

Silvio Nitzsche, WEIN | KULTUR | BAR Dresden



For further information about the VISION series, philosophy and a far-reaching analysis of sommelier Silvio Nitzsche, please visit: www.zieher.com/en/highlights/vision

VISION



Silvio Nitzsche

"Of course, there is life without wine, but who wants that?"

For more than 30 years, Silvio Nitzsche has looked after both the guests and the wine as a sommelier, amongst others in some of the best Michelin-starred restaurants.

Some of his high-profile positions have been:

- Sommelier at "Dieter Müller Restaurant" (19,5 GM, *** Michelin), Bergisch Gladbach / GER
- Sommelier at "Erna's Elderberry House", Oakhurst / CA, USA Assistant Restaurant Manager and Sommelier at "Speisemeisterei" restaurant (18 GM, ** Michelin), Stuttgart / GER
- Management of the wine retail and wholesale company KierdorfWein

In 2007, the sommelier found a new home in Dresden. Opening the WEIN | KULTUR | BAR he and his team managed to establish one of the best wine bars in Europe in the wine consciousness of many. He has succeeded in creating a place where wine is a given. It is not for nothing that he has already won the "Best Wine List of the Year" award six times.

In his professional life he has received numerous awards for his work and for his company. Silvio has been voted one of the ten best sommeliers in Germany by "Der Feinschmecker" magazine several times and was awarded the "Award of Honor" in 2019. He was recently named "Sommelier of the Year" by Falstaff magazine.

The WEIN | KULTUR | BAR is listed in Gault & Millau and is quoted by Falstaff BARGUIDE 2024 as Germany's best wine bar.

www.weinkulturbar.de



Filigree craftsmanship meets innovative design

"Zieher glasses are all about top quality craftsmanship, which is created in one of the most innovative and best glass-blowing workshops in the world. Each glass is unique and has been created from lead-free crystalline glass, using a traditional glass-blowing method.

As well as having a perfect, highly sophisticated and fascinating design, the glasses in the VISION range are guaranteed to provide maximum aroma and optimum development of the wine.

However, it is particularly the fascination of the light, the colours and the visual depth, that makes it impossible to tear your eyes away from the glass, because: You have never seen wine like this!"

Silvio Nitzsche



FRESH now with effervescent point!



Get to know VISION!

The glasses FRESH, STRAIGHT, INTENSE and BALANCED are also available in a single package.

The Zieher Food – VISION



→ Wine glass lid "Tesoro" | p. 206

The VISION series is predestined for wine and has been created to perfectly represent its different facets. In addition to this, the glasses offer an extraordinary platform for small delicacies or complimentary dishes from the chef. The harmonic wavy shape of the bottom creates an eye-catching ring when filled with spume or liquids. The depression in its centre provides space for amuse bouches or decorative highlights.

Please note

enclosed care instructions!
Further information | p. 208



FRESH

crystalline glass, transparent, handblown, including effervescent point

item	Ø / height in cm	content in ml	PU
5480.01	8/24	approx. 340	2 pcs
5480.01-1	8/24	approx. 340	1 pc

For extremely fresh white wines, Prosecco or any variety of sparkling wine, light rosé wines

The wide opening of this glass allows the carbon dioxide in sparkling wines to gently evaporate. This prevents the aroma perception of the nose from being broadsided by a concentration of carbon dioxide, which is often the case with classic sparkling wine glasses. The glass provides the palate with a centralised aroma concentration, which allows the wine to express its exquisitely lively, refreshing and light character. The development of the flavour-carrying, freshly acidic structures is encouraged, and individual features of the bouquet are brought into focus. The effervescent point at the bottom of the goblet creates a fine string of rising carbon dioxide bubbles in sparkling wine.

STRAIGHT

crystalline glass, transparent, handblown

item	Ø / height in cm	content in ml	PU
5480.02	9/27	approx. 540	2 pcs
5480.02-1	9/27	approx. 540	1 pc

For pure grape varieties and fruity / aromatic red and white wines

The characteristics of the wine are reflected harmoniously one-to-one in this glass. The authenticity of the aroma culture of a grape variety is made discernible and presented in an unpretentious way, which makes this glass particularly suitable for all types of authentic grape varieties such as Riesling or Sauvignon Blanc. Light, aromatic red wines are transformed into pure drinking enjoyment.

INTENSE

crystalline glass, transparent, handblown

item	Ø / height in cm	content in ml	PU
5480.03	10.5/28	approx. 640	2 pcs
5480.03-1	10.5/28	approx. 640	1 pc

For opulent, great growth, powerful white and red wines, rustic, acidic white and red wines, young and middle aged Bordeaux wines

The tapering neck of this glass intensifies the aroma molecules, which are positively hurled out of the glass. The acidity is harmoniously structured in the fruit bouquet and completes the opulent overall sensation of strength. The glass provides intensive oxidation, making it ideal for any wine that can be decanted or served in carafes.

BALANCED

crystalline glass, transparent, handblown

item	Ø / height in cm	content in ml	PU
5480.04	12/25	approx. 850	2 pcs
5480.04-1	12/25	approx. 850	1 pc

For white and red Burgundy, great Piedmontese wines, highly complex but sensitive white and red wines, extremely opulent rosé wines and old vintage champagne

A perfect glass for wine that is not for decanting due to its sensitive structure, but still requires a great deal of air. This crystal emanates pure consonance. Even with discordant wines, it succeeds in creating a concentrated and highly elegant impression. This glass turns wine into a complete aromatic experience, without overdoing it.

RICH

crystalline glass, transparent, handblown

item	Ø / height in cm	content in ml	PU
5480.05	7/23	approx. 280	2 pcs

For fortified, sweet and dessert wines and any type of distilled beverages

A glass for the majority of heavyweight or high-proof drinks. The small presentation surface ensures that the wine or brandy does not become overly concentrated, so that the heavyweight aromatic elements are released in a nuanced way. Due to the glass having a narrow opening, the nose cannot go in very far, which prevents the perceiving mucous membranes from receiving a barrage of alcohol.

NOSTALGIC

crystalline glass, transparent, handblown

item	Ø / height in cm	content in ml	PU
5480.06	10.5/16.5	approx. 250	2 pcs

For cocktails or as a food glass

The wide chalice is perfect for elegant presentations of creative cocktails, spectacular hors d'oeuvres or sophisticated sweets. Ideal in combination with SIDE for plain water, for easy service distinguishing both types of water.

SIDE

crystalline glass, transparent, handblown

item	Ø / height in cm	content in ml	PU
5480.07	9/10.5	approx. 480	2 pcs

For carbonated mineral water and soft drinks

Complementing the wine glass series, this glass is the tasteful companion for a stylish presentation of carbonated mineral water and soft drinks. The carbon dioxide is harmonised and the acids and mineral elements of fine sources are delivered to the tongue and the palate in a refreshing way, without being intrusive.



The product:

The “Tesoro” wine glass lid preserves the volatile aromas and fits on every VISION wine glass. At the same time it protects the wine from flying insects and other foreign bodies.

The lids are made of high-quality borosilicate glass, which originates from the laboratory sector and is known for excellent chemical resistance and high light transmission in combination with a flawless surface quality.

The break-proof glass can easily be cleaned in the dishwasher and is odourless - the basic requirement for preserving the aromas of the wine.

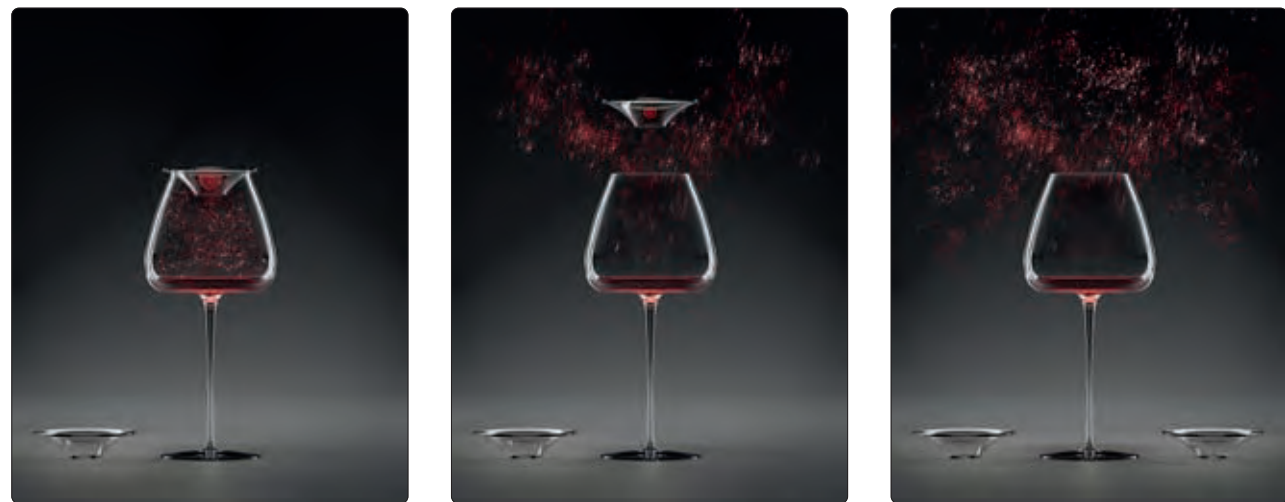

Putting the rule to the test:

Take two glasses of the same kind. Now fill both of them equally. “Seal” one of the glasses with “Tesoro” and leave the other one open. Wait for just five minutes and then smell both glasses.

Both wines will be identical in taste! This reflects the development the opened wine is nevertheless going through. Note the variety of aromas, which you can absorb and analyse in the glass previously closed with the lid. You will be astonished.

Tapas culture:

Tapas (lit.: small lids) meanwhile have become a gastronomic concept. According to the actual literal origin, you can arrange accompanying snacks and sweets on the “Tesoro” and serve them to your guests with the wine glass.



wine glass lid “Tesoro”
borosilicate glass, transparent, handblown

item	Ø in cm	height in cm	PU
5478	9	2.3	2 pcs. 📦
5478-06	9	2.3	6 pcs.

Covers fine wines, preserves volatile aromas and acts as a serving lid.

An aid to wine enjoyment!

“It’s not just a wine glass lid, it’s about capturing transience.

Hardly anything is as volatile as the wine aromas that escape from an open bottle or a filled wine glass. It happens automatically and naturally. It is irreversible and, in retrospect, often leaves a feeling of regret for not being able to capture the moment.

Sometimes it’s in fact the small and inconspicuous things that leave a particularly big and lasting impression - like the “Tesoro” wine glass lid. It creates wine experiences you have never before consciously and obviously perceived.”

Silvio Nitzsche, WEIN|KULTUR|BAR, Dresden



The function:

Inside a wine glass, a microcosm of different aroma molecules is created. The variety of primary, secondary and tertiary fragrances emanates from a wine glass in several stages and cannot be enjoyed in interplay.

The “Tesoro” lid preserves the volatile aromas within the glass. The wine does not develop more slowly, but the fragrance molecules, which normally vanish, can be perceived gradually or together - at your own discretion. Thus the little enjoyment helper enables a completely new wine experience.

VISION



Care instructions VISION:

To maintain the attractive appearance of the glasses for as long as possible, we recommend washing by hand. If you do use the dishwasher, we suggest the following:

- Select the shortest possible rinsing cycle at low temperatures, use a cleaning agent that is suitable for glasses, and ensure that the water hardness is between 4 and 6.
- Remove your glasses from the dishwasher as soon as the rinsing cycle is completed if possible.
- Polish your glasses with half-linen or microfibre towels for the best result. Cotton towels may leave small scratches and traces of lint.
- It is best to use 2 cloths for drying. This way you can polish the glass from the inside and outside at the same time. Please avoid to turn the base, as this may cause the stem to brake.

The premium polishing cloth made of microfibre is scratch- and lint-free, which makes it excellently suited for polishing wine glasses and decanters. The polishing cloth is washable at up to 90 degrees celsius and ensures streak-free results. Please follow the care instructions.



glasses polishing cloth

premium polishing cloth made from polyester, microfibre, white, suitable for washing machines

item	l x w in cm
5664	70x43.5

The VISION presentation case is a sturdy hard-shell case with a foam insert precisely fitting for all glasses of the VISION series and the ideal tool for presenting the glasses to interested parties on site.



VISION presentation case

hard shell cases with foam layer, incl. VISION glasses (5480.01 - .07), premium polishing cloth, cotton gloves and information flyer about VISION and decanters

item	l x w x h in cm
5661.02	65x34.5x18



Further information:
WWW.ZIEHER-VISION.COM

For series VISION, we recommend the CAMBRO - Camrack® Warewashing System

If you are interested or if there are any questions, please don't hesitate to contact your Cambro representative.



Camrack® 4-in-1 Warewashing System

- Efficient washing
- Optimum sanitary storage
- Inventory control
- Safe, sanitary transportation

The Camrack® Warewashing System will protect your valuable stemware and tumblers not only during washing, but also during stacking, storage and transportation. This helps to avoid costs related to damaged glasses. Detailed information about the Camrack® Warewashing System is available at www.cambro.com.

Camrack® Warewashing System

Cambro® offers a 4-in-1 system where glassware is washed, stored, identified and transported in one single unit. This multipurpose unit involves the Camdolly®, Camrack® compartment racks and the Camrack® cover.

Accessories - Dolly and Cover



item	l x w x h in cm	colour
CDR2020	54.3x54.3x20.3	soft grey (1.51)



item	l x w x h in cm	colour
DRC2020	50x50x2.4	grey (1.80)



Feedbacks to the wine glass series VISION



Andrea Zigrossi, Italy
[instagram.com/trotterwine](https://www.instagram.com/trotterwine)

"I can say that my first encounter with Zieher glasses was "love at first taste". Finding glasses that enhance the tasting experience to the maximum is not easy, and the VISION Series succeeds in full! Thanks to the unique design and the lightweight material, the wine is excellently expressed making the tasting flawless."

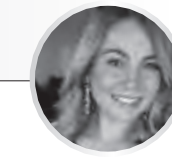

Annika Hohmann, Germany
[instagram.com/the_hunting_wine_girl](https://www.instagram.com/the_hunting_wine_girl)

"Special about the VISION series is that we are talking about character glasses. We approach the wine individually through the glass and thus receive a much more intense experience of pleasure. The glasses are not only eye-catching but also enrich our palate."



Thomas Dötzer, Germany
www.doetzers.de

"From the very beginning, we have been excited by the appearance and the design of the glasses. But after the first degustation, we have been enthusiastic! We did not want to stop tasting. The wine simply gains a different character. The BALANCED glass makes decanting superfluous and a Grappa out of the RICH glass is simply a great experience!"



Emanuele Trono, Italy
[Instagram.com/enoblogger](https://www.instagram.com/enoblogger)

"My experiences with the Zieher VISION series have been outstanding. The glasses praise the wine, they are extremely light, give expressiveness to the wine and are also a beautiful design object. They are a must-have for every wine lover and I also became Zieher-addicted."

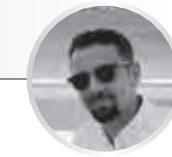

Ed Agg, Australia
[instagram.com/thecellarpost](https://www.instagram.com/thecellarpost)

"The Zieher VISION range is the marriage of exceptional design and an uncompromising approach to enhancing the wine experience. It's these characteristics that make the VISION range both a work of art, and the most precise, reliable, and exciting glassware one can own."



Walid Romaya, USA
[instagram.com/princeofwine](https://www.instagram.com/princeofwine)

"As a wine influencer, I have tasted thousands of wines in all glass shapes and sizes. The INTENSE wine glass is the perfect balance of beauty and functionality. It is a piece of art in your hand, that delivers and intensifies the wine aromas and characteristics through its unique and beautiful bulbous base. When using the glass for wine tastings in bars, people literally flooded me with comments about its beauty. Simply spectacular and one of the best wine glasses I have ever tasted with."



Rasmus Christensen, Denmark
[instagram.com/winewherever](https://www.instagram.com/winewherever)

"The VISION series have a remarkable ability to bundle the fragrance, while providing an elegant and aesthetic appearance."

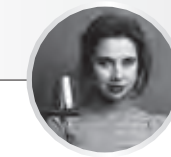

Elisa Dublyanska, Italy
[instagram.com/ilviaggioinuncalice](https://www.instagram.com/ilviaggioinuncalice)

"The INTENSE glasses from the VISION collection are my favourite! A perfect combination of quality, innovative design and elegance. They give a unique tasting experience."

#ziehermoment

Follow us on social media and stay tuned!



facebook.com/Zieher



[instagram.com/Zieher_Selection](https://www.instagram.com/Zieher_Selection)



youtube.com/user/ZieherGermany



linkedin.com/company/zieher-kg



xing.com/companies/zieherkg

Decanters

"Star"



"Star" - mini



"Doppio"



"Eddy"



"Star"





"Doppio" – how about a little extra?

In the "Doppio" decanter, wine is given a double stage that attracts attention and provides surprising effects.

The geometric silhouette and the reduced design directs the view to the inside, because the whole secret of this extraordinary design discloses in filled condition.

Attractive visual effects appear already during the pouring process when the wine is divided onto both levels of the "Doppio" decanter. It almost seems that the wine is levitating.

In addition to the natural flow of the wine, which pours over the inside of the decanter onto the two levels, the division into two levels also has a beneficial effect on the development of the wine. The splitting creates a significantly larger surface of the wine with a comparatively small space requirement on the table, which maximises the possible oxygen contact. The division also remains when pouring out, so that the cascaded flow creates a waterfall effect, which additionally increases aeration through swirling.

"Doppio" is elaborately handcrafted from high quality borosilicate glass, which is robust and easy to clean. The ideal charge of the decanter is 0.75 litre in order to generate maximum oxygen contact and the most beautiful optical effects.

Design: Itamar Harari



decanter/carafe "Doppio"

borosilicate glass, transparent, handblown

item	Ø in cm	height in cm	content (decanter) in l
4894	20	30	approx. 1.75

decanter/carafe "Doppio"

in black gift box

item	Ø in cm	height in cm	content (decanter) in l
4894.PB	20	30	approx. 1.75

→ Decanter dry racks
p. 222/223



Further information about "Doppio"



"Star" - mini

Uniqueness in practice

"Many decanters provide a fast but completely unbalanced development of wines because the wines develop only by a macro-oxidation on the surface. It's more balanced and harmonic to implement the necessary oxygen in a very soft and gentle way.

The filigree rays of the centric star animate the served wine to a very soft enhancement. During the slewing, the oxygen is mildly folded in and integrated into the wine. Thus the wine starts to develop on its own terms and not – as with other decanters – just on the surface.

The swirling of the wine is a fascinating view and helps in a three-dimensional development to harmonise the acid and to synchronise different levels of aroma.

By using borosilicate glass as raw material for this decanter, which sticks out by its extremely smooth surface, another highly pleasant effect is that the aromatic molecules aren't expelled from the wine but allowed to present themselves completely in the wine glass. The aerated wine becomes extremely balanced, carefully crafted and centered. An additional value which is simply priceless!"

Silvio Nitzsche, WEIN|KULTUR|BAR Dresden



Cocktail: Spanish Stargazer

→ VISION Nostalgic | p. 205

The small "Star" - mini is particularly suitable for the decantation of open wines or small bottles. The ideal charge to provide a maximum of oxygen is 0.375 ltr. The reduced size allows to decant white wines and still to temper them in wine coolers. Also for dessert wines, the staging of innovative high-end cocktails, flavoured spirits, to the point of exotic juices – this unique product is the perfect solution.



More information about "Star"



Please note:

The ideal charge to provide a maximum of oxygen is 0.375 ltr. ("Star" - mini).



decanter/carafe "Star" - mini

borosilicate glass, transparent, handblown

item	Ø in cm	height in cm	content (bowl) in l
4945	11.5	24	approx. 0.7

decanter/carafe "Star" - mini

in black gift box

item	Ø in cm	height in cm	content (bowl) in l
4945.PB	11.5	24	approx. 0.7



decanter/carafe "Star" - mini with VISION "Straight"

set consists of:

1 decanter/carafe "Star" - mini
borosilicate glass, Ø 11.5 cm, height 24 cm, content bowl approx. 0.7 l

2 wine glasses VISION "Straight"
crystalline glass, transparent, handblown, Ø 9 cm, height 27 cm, content 540 ml
1 set in black gift box

item	PU
4946.PB	1 set (3 parts)



decanter/carafe "Star"

borosilicate glass, transparent, handblown

item	Ø in cm	height in cm	content (bowl) in l
4947	15.5	32	approx. 1.8



pedestal/ring

silicone, Ø 13.4 cm, optionally available pedestal for positioning the decanter "Eddy" (item 4883) and "Star" (item 4947) at an angle

item	colour	PU
4682.S	black	3 pcs



decanter/carafe "Star" with ring

set consists of:

1 decanter/carafe "Star"
borosilicate glass, Ø 15.5 cm, height 32 cm, content bowl approx. 1.8 l

1 ring
silicone, black, Ø 13.4 cm
1 set in black gift box

item	PU
4948.PB	1 set (2 parts)



→ Decanter dry racks p. 222/223

"Star"

The art of decanting

The decanter "Star" synergises the aesthetics of a unique copy with the functionality of a professional tool for vinophile pleasure.

Based on products from glassblower Detlef Greiner-Perth and presented by Silvio Nitzsche, "Star" is possibly the most fascinating wine carafe in a long time, due to its exceptional design.

The individual star raises each carafe to an exceptional piece and forms a fascinating basis for discussions with interested guests. This artistically designed centerpiece becomes a unique element in a complex process due to numerous processing steps. This is pure luxury in our uniform world because not a single "Star" is like another.

Idea: Detlef Greiner-Perth



reddot winner 2020

Recessed grip at the bottom for better handling!



The big "Star" has a recessed grip in the bottom, which on the one hand improves the swirl during filling and slewing, on the other hand it ensures good handling and a secure hold when serving the wine.

The collar, which is included in the gift box, is made of matt black silicone and also allows an inclined positioning.



Follow us on YouTube: Making of "Star"



"Eddy" - mini

The small "Eddy" - mini is perfectly suitable for the decanting of wines by the glass and little bottles. Thereby the ideal charge to maximise the content of oxygen is 0.375 litre. The compact design is perfectly suitable to decant white wines first and then to temper in a wine cooler. By the extravagant character of this design item, even high-end cocktails and other exotic creations can be staged harmoniously.

The basic material for this development worker for wine is extremely robust, high-grade borosilicate glass. This type of glass, which stands out due to its dense structure, extraordinary transparency and hardness, is the precondition for the implementation of the introversive swirl elements. In an interplay with light and the contained wine, they create visually interesting colour reflections and graphic effects.



Further information about "Eddy"



decanter/carafe "Eddy" - mini
borosilicate glass, transparent, handblown

item	Ø in cm	height in cm	content (bowl) in l
4891	12	25	approx. 0.8

decanter/carafe "Eddy" - mini
in black gift box

item	Ø in cm	height in cm	content (bowl) in l
4891.PB	12	25	approx. 0.8



decanter/carafe "Eddy" - mini with VISION "Straight"

set consists of:
1 decanter/carafe "Eddy" - mini
 borosilicate glass, Ø 12 cm, height 25 cm, content bowl approx. 0.8 l
2 wine glasses VISION "Straight"
 crystalline glass, transparent, handblown, Ø 9 cm, height 27 cm, content 540 ml
 1 set in black gift box

item	PU
4892.PB	1 set (3 parts)

"Eddy" - the wine development worker



→ Illuminated ring | p. 220



decanter/carafe "Eddy" with ring

set consists of:
1 decanter made of borosilicate glass, transparent, handblown, approx. 2.3 l content
1 ring made of silicone, black,
 1 set in black gift box

item	Ø in cm	height in cm	PU
4884.PB	17	35	1 set (2 parts)



decanter/carafe "Eddy"

borosilicate glass, transparent, handblown

item	Ø in cm	height in cm	content in l
4883	17	33	approx. 2.3



pedestal/ring

silicone, Ø 13.4 cm, optionally available pedestal for positioning the decanter "Eddy" (item 4883) and "Star" (item 4947) at an angle

item	colour	PU
4682.S	black	3 pcs



Follow us on YouTube: Video "Eddy"



"The decanter "Eddy" defines the world of extreme wine instruments in a completely new way. Their functionality has seldom been united with an aesthetic language of design in such a spellbinding way. The matchlessly fast-paced development of structure, which all wines undergo in that respirator, is really fascinating! Once rotating in this texture stimulator, due to the thousand-fold swirls at the conical indentations, the wine goes through a process, whose behavior is equivalent to an oxidation reaction of several hours, within a few seconds."

Silvio Nitzsche - WEIN | KULTUR | BAR - Dresden

The volume of the big "Eddy" has been dimensioned in a way that, with a filling of up to 1.5 litre, the extension of the wines surface becomes as large as possible. Due to the flattened bottom, "Eddy" stands safely and straight, the ring, which is included in the gift box, is made of matt black silicone and also allows an inclined positioning.



→ Decanter dry racks p. 222/223

"Pebble"

"Pebble" is made of high-grade, lead free crystal glass. The unfilled decanter inspires by the brilliance of the glass alone and the resulting light reflections.

These products are hand-blown with perfect craftsmanship. The sensitivity and longstanding experience of the glass blowers become apparent in particular in the creation of the bottom, which is extensively dimensioned and separated into three convex segments.

While filling the decanter the wine flows, due to the shaping of the neck, along the complete inside area, which maximises the surface of the wine and thus contributes to the aeration. The three swales at the bottom serve to further swirl the poured wine, which results in a gentle but nevertheless very effective aeration. This effect can be intensified by warily swinging the filled decanter.

The diagonal cut of the neck and the accurate polishing of the raw edges minimise the formation of drops while pouring out.

Design: Itamar Harari



decanter/carafe "Pebble"

crystal glass, transparent, handblown

item	Ø in cm	height in cm	content in l
4890	20	30	approx. 1.8

decanter/carafe "Pebble"

in black gift box

item	Ø in cm	height in cm	content in l
4890.PB	20	30	approx. 1.8 

Decanter accessories



Spot on! – base ring with LED-light



This base ring for the "Eddy" (item 4883) and "Star" (item 4947) decanters offers the chance to stage served wine through light.

The rechargeable Zieher LED-light (item 8150) fits exactly into the cavity at the bottom part of the ring and thus puts the served wine inside the decanter into the limelight in a fascinating way. In the beginning, the illumination effect in the filled decanter can be very unobtrusive when serving strongly pigmented red wine. But at a decreasing level, the play of light and colours becomes more and more intense in an exciting way.

These accessories are also suitable to illuminate glass bowls and -platters. In combination with the ring, the LED-light and remote control still maintain their known options, such as adjustable brightness, 7 different colours and various colour-changing functions. Detailed information about the Zieher rechargeable LED-light can be found on page 53.

All components (ring, light, remote control and charger) are available either as single parts or as a set in a gift box.



pedestal/ring, illuminable

silicone, black, optionally available pedestal for positioning the decanter "Star" item 4947 and "Eddy" item 4883 at an angle, suitable for rechargeable LED-light item 8150

item	Ø in cm	height in cm
4679.S	15.2	5.5



basic ring with LED-light

set consists of:
1 ring made of silicone, black
1 rechargeable LED-light incl. charging device EU and remote control
 1 set in black gift box

item	PU
8153.01PB	1 set (4 parts)



Detailed description
rechargeable LED-light



Please note:

The chargers in the gift box are equipped with a EU plug, chargers with US resp. UK plugs are available upon request.

Carved in Stone

On hot days, decanting wine while keeping it at the optimal drinking temperature can be quite a challenge. The decanter cooler "On The Rocks" offers an innovative and highly aesthetic solution for this situation.

"On The Rocks" has been exclusively designed for Zieher decanters "Eddy" (item 4883) and "Star" (item 4947). The selected grey marble is captivating due to the diverse patterns of its marbling. Each piece is unique and offers the opportunity to decant and simultaneously chill white, rosé, and red wines in a stylish manner.

The top part of the cooler is stored in the freezer, while the matching base remains unchilled. It captures the condensation that forms on the frosted top part during use, ensuring that the table remains dry and free from unwanted water stains. The frozen shell ensures that the wine maintains the desired drinking temperature for longer on hot days. Two silicone rings, included in the set (8059.PB), dampen noise and protect the decanters when inserted into the cooler.

With "On The Rocks", chilled dishes can also be presented and served on ice in an exceptional way. From oysters or a small serving of caviar to a selection of delightful pralines, the possibilities are virtually limitless (page 185).

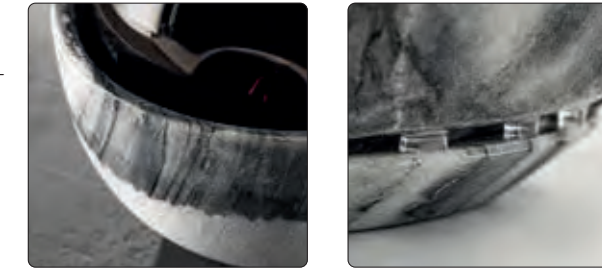

bowl "On The Rocks"

marble, grey patterned, polished, food-safe coating, not dishwasher-safe, for coaster "On The Rocks" item 8058

item	Ø / height in cm	content in l
8057	approx. 20.5/10	approx. 1.4



coaster "On The Rocks"

marble, grey patterned, polished, food-safe coating, not dishwasher-safe, for bowl "On The Rocks" item 8057

item	Ø in cm	height in cm
8058	approx. 14	approx. 2

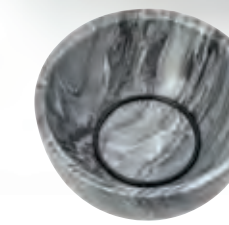

wine/decanter cooler "On The Rocks"

set consists of:
bowl and saucer made of marble, grey patterned, polished, food-safe sealed, not dishwasher-safe
2 silicone rings for decanter "Eddy" (4884.PB) and decanter "Star" (4948.PB)
 1 set in black gift box

item	Ø / height in cm	content in l	PU
8059.PB	approx. 20.5/11	approx. 1.4 L	1 set (4 parts)



Please note:

"On The Rocks" is suitable for Zieher decanters "Eddy" (4883) and "Star" (4947).

Marble is a natural product and the grey marbling can vary significantly, creating a lively and exceptional effect for this natural stone.

Certain foods, especially those containing fruit acids (citric acid), can potentially affect the surface with prolonged contact. Therefore we recommend avoiding direct contact with food. Please clean with a damp cloth and mild cleaning agents only. Not dishwasher-safe.



Creating a useful tool with a high demand on aesthetics – this was the idea during the development of "DryPod". The solid rack made of brushed stainless steel, PVD refined in either black or brass coloured, forms the basis for this shapely product. An accurately fitting drip tray, made of translucent resin, is placed inside the rack and harmonises with its anthracite colouration with both variants.

Primarily "DryPod" is a drying rack for decanters. The geometry was chosen in a way that all Zieher decanters can be placed safely, besides the big variations of "Eddy", "Star", "Doppio" a.s.o., it can also take hold of the smaller versions of some types as well as many other decanters in classical format. The drip tray securely collects dripping water and can be easily removed for cleaning.

Even after drying, all decanters are well stored in "DryPod". No matter if in a showcase or on the shelf, the decanter is stylishly presented by the precious display. Here, the downward-pointing opening helps prevent dirt from getting in easily.

Besides its actual determination, "DryPod" is tempting by its versatility. As an etagere on the laid table or in the hotel room, the item can be equipped with numerous other Zieher articles and thus presents food and delicacies in an impressive way.

Please find a selection of fitting combinations as well as further inspirations on pages 273 and 302.



→ "Star" | p. 215 → "Pebble" | p. 218 → "Doppio" | p. 212 → "Eddy" | p. 217

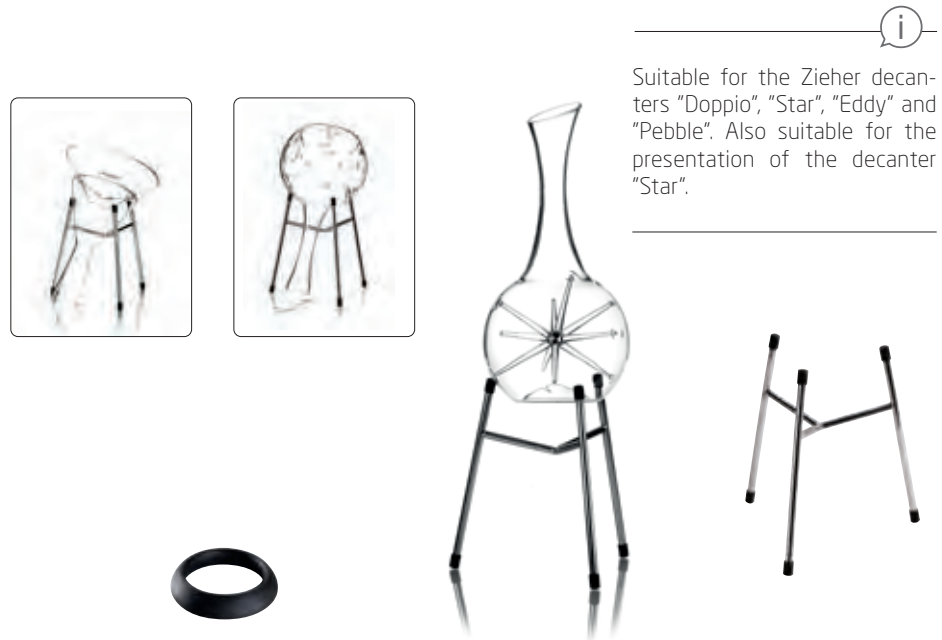

Suitable for the Zieher decanters "Doppio", "Star", "Eddy" and "Pebble". Also suitable for the presentation of the decanter "Star".

pedestal/ring
silicone, Ø 13.4 cm, optionally available pedestal for positioning the decanter "Eddy" (item 4883) and "Star" (item 4947) at an angle

item	colour	PU
4682.S	black	3 pcs

decanter dry rack "Stablo"
stainless steel 18/10, polished, 8 mm thick, with 6 anti-slip rubber caps, suitable for decanters "Eddy" (4883), "Star" (4947), "Pebble" (4890) and "Doppio" (4894), in black gift box

item	Ø top/bottom in cm	height in cm	PU
8014.20PB	15/23	20	1 pc



dry rack/display "DryPod" with drip tray
set consists of:
dry rack/display stainless steel 18/10, brushed, pvd-coated
drip tray made of resin, anthracite, matt, translucent
1 set in black gift box

item	Ø in cm	height in cm	colour
2231.PB	18	26	brass
2233.PB	18	26	black



decanter dry rack/display "DryPod"
massive stainless steel 18/10, brushed, pvd-coated, with 3 anti-slip rubber feet (not dishwasher-safe), suitable for all Zieher decanters

item	Ø in cm	height in cm	colour
2230	18	26	brass
2232	18	26	black



drip tray
resin, anthracite, matt, translucent, not dishwasher-safe, suitable for decanter dry rack "DryPod" items 2230 and 2232

item	Ø in cm	height in cm
7030	12.5	1



→ All information about "Stablo" | p. 110-111



Please note:

For one buffet stand "Stablo" XL ring item 8016.01 only one set of extensions is required.

Extension for buffet stand XL ring

801740: for a total height of 80 cm

801760: for a total height of 100 cm

801780: for a total height of 120 cm



wine cooler

borosilicate glass, transparent, handblown, handmade, reinforced version, for "Stablo" M, L items 8015.30 and 8015.40 (by positioning the cooler at an angle) and "Stablo" XL ring item 8016.01

item	Ø in cm	height in cm
4881.26	26	approx. 43

 Also available separately on request



buffet stand "Stablo" XL-ring

massive stainless steel 18/10, polished, 12 mm thick, with ring-opening (Ø 12 cm inside) for wine cooler items 4881.26, with 6 anti-slip rubber caps, 3 of which are separately packed (to clip onto the bottom part while not using the extensions items 8017... please order the extensions separately)

item	Ø upper/lower in cm	height in cm	PU
8016.01	22.5/37	40	3 pcs



extension "Stablo"

massive stainless steel 18/10, polished, 12 mm thick, with anti-slip rubber caps, for buffet stand "Stablo" item 8016.01 (not suitable for items 8014... and 8015...)

item	length in cm	PU
801740	40	1 set (3 parts)
801760	60	1 set (3 parts)
801780	80	1 set (3 parts)

"Mikado" – cool staging!

The bottle cooler "Mikado" is made of solid stainless steel and high gloss polished. Due to its weight and the generously dimensioned floor area, the solid frame has the required stability to offer the matching cooler made of hand-blown glass a secure hold.

Additional silicone rings on the upper side of the rods treat the glass body with care and avoid disturbing noise.

A very special highlight creates the optionally available waterproof LED-light, which can be placed right inside the cooler. Multiple colours and functions can be adjusted by a remote control, an optionally available supporting ring keeps the light in position. All information about the LED-light can be found on page 53.

The glass insert of the "Mikado" bottle cooler can also be used as cloche. The reinforced quality, which is indispensable for the use as a cooler, brings besides the slightly higher weight also an obviously improved stability. The integrated ball grip at the top provides an easy handling when used as a cloche (page 194).

Design: Itamar Harari



glass cloche/wine cooler

clear glass, handblown, reinforced version, with round handle, for coaster "Solid" item 4734.02 (as cloche) and wine cooler stand item 2220.70 (as wine cooler)

item	Ø in cm	height in cm
4848	22.5	26

→ Rechargeable LED-light item 8150 and suitable accessories | p. 53



<https://www.zieher.com/en/service/instruction-manuals/>



wine cooler stand "Mikado"

massive stainless steel 18/10, polished

item	Ø in cm	height in cm
2220.70	approx. 24	approx. 70



Positioning of ring and light in wine cooler 4881.26 or 4848



ring "SelectionA."

silicone, Ø 8.3 cm

item	colour	PU
4681.S	black	6 pcs





EDDY - DASH!



THE VIKING III



THE PILL



THE KNOBBED



THE VIKING II

For drinks with character

THE BAR COLLECTION by Zieher enriches the bar scene with new characters which are predestined for independent creations beyond the cocktail mainstream. Each jar playfully and humorously picks up on a different theme and thus exudes a good portion of humor in its own way.

Made of particularly break-proof and temperature-resistant borosilicate glass, all glasses not only offer an extravagant outer shell, but with a capacity of up to 500 ml, also provide plenty of space for extraordinary experiments and countless recipes.

Despite their differences, all glasses are easy to combine and create possibilities that go far beyond serving a drink. Besides the taste, a haptic and visual experience is generated as well, which fulfils the basis of modern cocktail staging.



"The Knobbed" plays with its content, because the attached knobs imitate the bubbles of carbonic acid in an amusing way. Interesting contradictions to the actual content can be taken to extremes here.



→ "Eddy - Dashi" | p. 230



cocktail glass "The Knobbed"
borosilicate glass, transparent, handblown

item	Ø / height in cm	content in l	PU
4972	8.5/12	0.5	6 pcs

"The Pill" allows for many associations: The risks and side effects of the drinks served in these glasses range from the feeling of well-being after consuming various healthy drinks to the intoxicating effects of high-proof cocktail creations.



Cocktail:
WONDER PILL



cocktail glass "The Pill"
borosilicate glass, upper part transparent, lower part satined, handblown

item	Ø / height in cm	content in l	PU
4970	8/14	0.47	6 pcs

"The Vikings" are vaguely reminiscent of the headgear of ancient Vikings. They offer a large, clear chalice on satined feet, in which strong cocktails can be staged transparently. The variant with two feet surprises with its tilted position, while the three-foot variant appears stable and yet almost floating.



→ Glass tray 5145 | p. 292



cocktail glass "The Viking II"
borosilicate glass, transparent, handblown, 2 satined feet

item	Ø / height in cm	content in l	PU
4974	8/11.5	0.4	6 pcs



cocktail glass "The Viking III"
borosilicate glass, transparent, handblown, 3 satined feet

item	Ø / height in cm	content in l	PU
4976	8.5/12	0.43	6 pcs



The dash bottle "Eddy - Dash!" for dosing bitter or sour ingredients is, alongside the glasses, an important part of THE BAR COLLECTION. A fitting squirt dispenser comes with every bottle. This vessel is formally based on the well-known "Eddy" wine decanters from Zieher and, in addition to being used as a dash bottle, also enables further uses. Thus for example, a "cocktail from the bottle" can be served in these vessels, the inwardly directed swirling bodies allow the ingredients to be mixed right before the drink is enjoyed.

The smallest "Eddy" can also be used in the restaurant. For this purpose, Zieher offers suitable cruets as well as matching bottle pourers with hygienic sealing caps, which allow the "Eddy - Dash!" to be used as an oil or vinegar bottle.



dash bottle "Eddy - Dash!" with drop pourer

borosilicate glass, transparent, handblown, incl. drop pourer item 1504

item	Ø in cm	height in cm	content in l
4893	9	14	0.35



freeflow pourer with flap

18/10 stainless steel, mirror polished finish, with natural cork and breather tube for smooth flow, suitable for dash bottle item 4893

item	Ø in cm	height in cm
1505	2.4	9



drop pourer

cork with plastic, for pouring tiny portions of liquid, suitable for dash bottle item 4893

item	Ø in cm	height in cm
1504	2.4	5.4



→ "Ménage-à-trois" | p. 285



→ Glass tray | p. 284

Miniatures



No sliding, no clattering – non-slip solutions from Zieher!



ring "SelectionA."
silicone, Ø 8.3 cm, for anti-slip placement of bowls item 5418, 4814.17, 4930 and 5478

item	colour	PU
4681.S	black	6 pcs



coaster
silicone, Ø 5 cm, 3 mm thick, temperature resistant (-40 °C to +230 °C), food-safe, with rim on one side, for anti-slip placement of miniatures

item	colour	PU
4661.05S	black	24 pcs
4661.05W	white	24 pcs



ring "SelectionA."
silicone, Ø 8.3 cm, for anti-slip placement of bowls item 5418, 4814.17 and 4930

item	colour	PU
4681.S	black	6 pcs



→ China series "DressCoat" | p. 182

Suitable inserts for ring 4681.S



small glass bowl
borosilicate glass, handblown, round

item	Ø / height in cm	content in l	PU
4930	7/5	approx. 0.14	24 pcs

glass bowl/cloche
clear glass, handblown, for ring "SelectionA." item 4681... (please order separately)

item	Ø/height in cm	content in l	PU
5418	9/6	0.2	6 pcs

glass bowl
dark grey laquered, round, handblown, ground edge, for ring "SelectionA." item 4681.S (please order separately)

item	Ø in cm	height in cm	content in l
4814.17	17	5.5	0.3

wine glass lid "Tesoro"
borosilicate glass, transparent, handblown

item	Ø in cm	height in cm	PU
5478	9	2.3	2 pcs.
5478-06	9	2.3	6 pcs.



→ Display + test tubes | p. 238



holder for the test tubes
silicone, Ø 4,6 cm 2,7 cm high, with grooves on the inside for easy insertion of glass tubes, for test tube item 4032.G

item	colour	PU
4680.S	black	6 pcs

The coasters made of food-safe silicone are shapely accessories with a highly practical benefit. Clattering and wildly sliding miniatures on plates and trays are therefore a thing of the past.

The skid-proof discs with their delicately structured, matt surface facilitate the service work and ensure undisturbed enjoyment for the guest. The coasters are available in two colours; the white ones can be integrated discreetly, whereas the black ones can be used deliberately as contrasting, decorative elements.

A ring and a test tube holder made of black silicone provide a stable base for numerous small bowls and miniatures.



→ "Flex-Tree" | p. 100

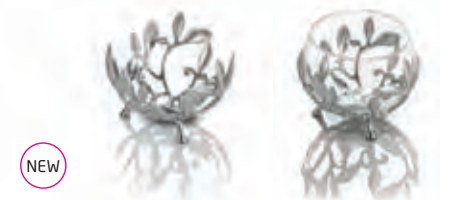

NEW

small bowl/basket "Leaf"
pewter, smooth outside, round, food-safe, not dishwasher-safe, with supporting feet, for small glass bowl item 4930 (please order separately)

item	Ø / height in cm	PU
2358	8/5	2 pcs



bowl/basket "Reef"
pewter, smooth outside, round, food-safe, not dishwasher-safe, with supporting feet, for small glass bowl item 4930 (please order separately)

item	Ø in cm	height in cm	PU
2318	8	5	2 pcs

"Reef" & "Leaf"



→ item 2311 | p. 72



glass bowl

dark grey, round, handblown, ground edge, handwash recommended

item	Ø / height in cm	content in l
4814.17	17/5.5	0.3



glass bowl

glass, 6 mm thick, dark grey, organically shaped

item	Ø / height in cm	content in l	PU
5166	13/6.5	approx. 0.3	2 pcs



small glass bowl

borosilicate glass, handblown, round

item	Ø / height in cm	content in l	PU
4930	7/5	0.14	24 pcs



bowl/basket "Reef"

pewter, smooth outside, round, food-safe, not dishwasher-safe, with supporting feet, for glass bowl item 4814.17 (please order separately)

item	Ø in cm	height in cm
2320	16	5.5



bowl/basket "Leaf"

pewter, smooth outside, round, food-safe, not dishwasher-safe, with supporting feet, for small glass bowl item 5166 (please order separately)

item	Ø in cm	height in cm
2350	13	8



bowl/basket "Reef"

pewter, smooth outside, round, food-safe, not dishwasher-safe, with supporting feet, for small glass bowl item 5166 (please order separately)

item	Ø in cm	height in cm
2310	13	8



small bowl/basket "Leaf"

pewter, smooth outside, round, food-safe, not dishwasher-safe, with supporting feet, for small glass bowl item 4930 (please order separately)

item	Ø / height in cm	PU
2358	8/5	2 pcs



bowl/basket "Reef"

pewter, smooth outside, round, food-safe, not dishwasher-safe, with supporting feet, for small glass bowl item 4930 (please order separately)

item	Ø / height in cm	PU
2318	8/5	2 pcs

Showpieces of table culture

Large numbers of single parts are cast from premium pewter and subsequently assembled in high-grade craftsmanship to give shape to these items. The inimitable pieces of art created that way are unique items, which inspire by the polished surface of the organic structures and the rounded tails of the meshwork.

The small presentation baskets can be equipped with miniatures made of clear or coloured glass and give your food a stunning stage.

Borosilicate glass in its most beautiful shape

The primary design element of the series "Cuspis" is a glass ball studded with fine spikes. The cloches with fitting porcelain plateau plates/bowls are available in three sizes, the inspiration for their shaping was derived from the nut of the oak tree. The unglazed outside of the porcelain bowls is reminiscent of acorn caps.

The bowls can be used on both sides. When used as a plateau plate, the dish moves closer to the guest, while the filigree glass cloche protects the presented delicacies and puts them in the limelight at the same time. Used as a bowl, it offers space for gravies, sauces and more.



Design: Michael Schwarz Müller



plateau plate/small bowl "Cuspis"

china, white, inside and useable area (plateau Ø approx. 6 cm/8 cm) glazed, outside biscuit, also useable as a bowl

item	Ø in cm	height in cm	content in l
4389.09	9	3	0.1
4389.11	11.5	3.5	0.18



glass cloche "Cuspis"

borosilicate glass, transparent, handblown, star-shaped ball handle

item	for plate/bowl	Ø in cm	height in cm
4940.08	4389.09	8.5	12.5
4940.10	4389.11	10.5	14.5



→ Big cloche "Cuspis" 4940.25 | p. 170



small glass bowl

borosilicate glass, inside with satin finish, handblown, double-walled

item	Ø / height in cm	content in l	PU
4963.01	6/8.5	approx. 0.05	6 pcs
4963.02	6.5/9.5	approx. 0.08	6 pcs



small glass bowl "Halfmoon"

borosilicate glass, inside with satin finish, handblown, double-walled

item	Ø / height in cm	content in l	PU
4964	12/7.5	approx. 0.35	6 pcs



small glass bowl "Halfmoon"

borosilicate glass, transparent, hand-blown, double-walled

item	Ø / height in cm	content in l	PU
4954.01	6/7.5	approx. 0.08	6 pcs
4954.02	8/9	approx. 0.17	6 pcs
4954.03	9/9.5	approx. 0.21	6 pcs



glass miniature

borosilicate glass, transparent, handblown, double-walled

item	Ø / height in cm	content in l	PU
4903	5.5/8.5	approx. 0.1	6 pcs



Handblown, double-walled glasses made of borosilicate glass combine spectacular optics and extraordinary technical features.

The vacuum between the two glasses prevents the formation of condensate on the outside of the glass when the ambient temperature is warm and the drinks are cold. The isolation effect keeps cold and warm liquids cold or warm for a longer time. Borosilicate glass by Zieher stands out due to its hardness and high temperature resistance.



glass bowl

borosilicate glass, transparent, handblown, double-walled

item	Ø / height in cm	content in l	PU
4956.01	9/4	approx. 0.07	6 pcs
4956.02	11/5.5	approx. 0.15	6 pcs
4956.03	13/6.5	approx. 0.25	4 pcs
4956.04	15/7	approx. 0.3	4 pcs

glass miniature

borosilicate glass, transparent, handblown, double-walled

item	Ø / height	content in l	PU
4901.01	6/5	approx. 0.08	6 pcs
4901.02	8.8/7.5	approx. 0.21	6 pcs



glass miniature

borosilicate glass, transparent, handblown, double-walled, with reinforced rim

item	Ø / height in cm	content in l	PU
4901.03	6/7.5	approx. 0.08	6 pcs



glass tumbler

borosilicate glass, transparent, handblown, double-walled

item	Ø / height in cm	content in l	PU
4907	8/10	approx. 0.28	6 pcs

Please note:

Since all glasses of this series are hand-blown, deviations from the declared content may occur.





→ Food displays | p. 280



test tube

test tube with flanged rim and round bottom, for holder for test tube item 4680.S and cork item 1501

item	Ø / height in cm	content in l	PU
4032.G	2/15	0.04	24 pcs

cork

for test tube item 4032.G

item	Ø in cm	length in cm	PU
1501	2/1.7	2.6	24 pcs

holder for test tubes

silicone, Ø 4.6 cm, 2.7 cm high, with grooves on the inside for easy insertion of glass tubes, for test tube item 4032.G

item	colour	PU
4680.S	black	6 pcs



coaster/glass insert

clear glass, 4 mm thick, round, edge polished and deburred, with 4 transparent silicone feet, for coaster "Solid" item 4700

item	Ø in cm	PU
5244	13	6 pcs



glass bowl

borosilicate glass, flat

item	Ø / height in cm	content in l	PU
4910	10.5/2.5	0.18	12 pcs

NEW

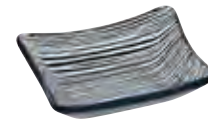

small glass bowl "Linea"

glass, 4 mm thick, clear, black line decor, rectangular, structured, dishwasher-safe

item	l x w in cm	PU
5032.09	9x7	12 pcs

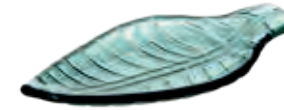

glass miniature plate

glass, 4 mm thick, green, structured, leaf shape

item	l x w in cm	PU
5037	14x7.5	12 pcs



small glass bowl

glass, deep black

item	l x w in cm	PU
5039.01	10x8.5	12 pcs



glass miniature plate

glass, deep black, flat

item	l x w in cm	PU
5034.01	10x10	12 pcs

Miniatures made of glass



→ Black china plates | p. 247
→ Etageres "Flex-Tree" | p. 100



small glass bowl

glass, 4 mm thick, structured, dark grey, round, with slight corners

item	Ø in cm	height in cm	PU
5173	8	3	12 pcs



small glass bowl/spoon rest

glass, 4 mm thick, structured, dark grey, organically shaped, slightly oval form

item	l x w in cm	PU
5172	11x7.5	12 pcs



small glass bowl

clear glass, structured

item	l x w in cm	PU
5039	10x8.5	12 pcs



small glass bowl

clear glass, structured, rectangular, flat

item	l x w x h in cm	PU
5099	11.5x5.5x1.5	12 pcs



Design: Wilma Greim

Like the shell hides the pearl, the porcelain bowl "Cave" conceals precious delicacies within its hard shell. At first sight, this porcelain piece only partly reveals its interior.

"Cave" consists of intricately worked hard porcelain and captures by its soft shaping and the velvety haptics of the unglazed outside. "Cave" is predestined for use at cocktail and hors d'oeuvres receptions or at the flying buffet. The miniature bowl can be carried comfortably and perfectly fits in the palm of the hand.



@Heike Witzgall | Photography for Franco Körperich, Switzerland



glass miniature, 2 parts
glass, satined, wavy rim

item	Ø / height in cm	content in l (bottom part)	PU
5445	5.5/7.5	approx. 0.05	6 pcs



glass miniature

clear glass, wavy rim, base: 0.07 l content, top part: 0.04 l content, for bridge "Modul" items 4584 and 4724

item	version	Ø / height in cm	PU
5423.01	base	6.5/5.5	12 pcs
5423.02	top	6.3/4.5	12 pcs



glass bowl "Gelo"

glass, inside structured, outside satined, round

item	Ø / height in cm	content in l	PU
5185.09	9/5	0.12	6 pcs
5185.14	14/4.5	0.35	12 pcs



glass pillow "Donna"

glass, satined, in black gift box

item	l x w x h in cm
5446.01PB	16.5x11x3

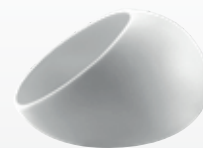

bowl "Cave"

biscuit china, white, inside glazed, opening: Ø approx. 8 cm, in black gift box

item	Ø in cm	height in cm
4375.01PB	approx. 11	7

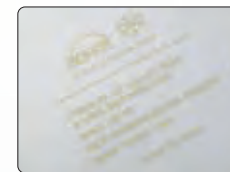

cooling pack

nylon, black/white, non-toxic cooling gel

item	l x w in cm
5663.20	20x20

Stay cool!

Serving chilled food is primarily a technical challenge with certain dishes or intermediate courses. With the two-coloured cooling pads, this necessity can be met in a sophisticated way, also in terms of visual appearance. The wrapper made of black respectively white nylon fabric appears classy and unobtrusive. The pads are filled with gel which remains shapeable, even when frozen and thus allows an adjustment to the tableware used.



→ Glass bowls "Cave" | p. 184



small bowl
china, square, 4.9 cm long, 4.9 cm wide, 7 cm high, 0.11 l content

item	l x w x h in cm	content in l	PU
3855.01	4.9x4.9x7	0.11	4 pcs



small bowl
china, square, 4.9 cm long, 4.9 cm wide, 4.5 cm high, 0.05 l content

item	colour	PU
3845	white	4 pcs
3845.01	black matt	4 pcs



miniature glass bottle
clear glass, round, with glass lid (round), with notched stopper for pouring with closed lid, height incl. lid

item	Ø in cm	height in cm	content in l
5741	4.3	5.5	approx. 0.03



glass bottle/creamer
clear glass, square, with glass stopper (round), with notched stopper for pouring with closed lid, height incl. stopper

item	l x w x h in cm	content in l	PU
5740	5x5x12.5	0.12	3 pcs



glass bottle
clear glass, square, with swing top (plastic and stainless steel), height incl. swing top

item	l x w x h in cm	content in l	PU
5295.01	5.4x5.4x12.5	0.1	12 pcs
5295.02	6.7x6.7x14.5	0.2	12 pcs



cork
plastic, ecru, for glass bottles items 5296.01 and 5296.02

item	Ø in mm	height in mm	PU
5297.01	2	2.2	24 pcs
5297.02	2.6	2.8	24 pcs



glass bottle
clear glass, square, suitable cork item 5297.01 and 5297.02 (please order separately)

item	l x w x h in cm	content in l	PU
5296.01	3.9x3.9x8.5	0.04	12 pcs
5296.02	4.9x4.9x11	0.1	12 pcs



small glass bowl
clear glass, square, delivery without lid item 5254.01 (please order separately)

item	l x w x h in cm	content in l	PU
5254	4.9x4.9x4.5	0.05	4 pcs



small glass creamer
clear glass, square, delivery without lid item 5254.01 (please order separately)

item	l x w x h in cm	content in l	PU
5255	4.9x4.9x4.5	0.05	4 pcs



glass miniature
clear glass, lid for small glass bowl item 5254 and glass creamer item 5255

item	l x w in cm	PU
5254.01	4.9x4.9	12 pcs

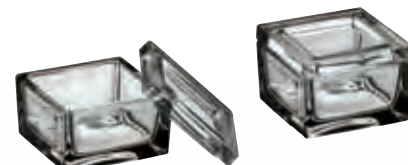

small bowl
clear glass, square, delivery without lid item 5338.01 (please order separately)

item	l x w x h in cm	content in l	PU
5338	7x7x3.9	0.1	12 pcs



glass miniature
clear glass, square, lid for small glass bowl item 5338

item	l x w in cm	PU
5338.01	7x7	12 pcs



small bowl
china, white, square

item	l x w x h in cm	content in l	PU
3853	7x7x2	0.05	12 pcs



→ Stainless steel cruet stand 2056.01 | p. 286



small bowl
china, white, square

item	l x w x h in cm	content in l	PU
3854	7x7x4.5	0.13	4 pcs



ashtray for cigars

optical glass, transparent, also usable as a rest for tongs or spoons, in black gift box

item	l x w x h in cm	PU
5210	15x9x3	6 pcs



glass bowl "Unique"

glass, white marbled, outside satined, round

item	Ø / height in cm	PU
5180.10	10/6	6 pcs



glass

clear glass

item	Ø / height in cm	content in l	PU
5380	7.5/10.5	0.32	6 pcs



→ "Unique" | p. 166

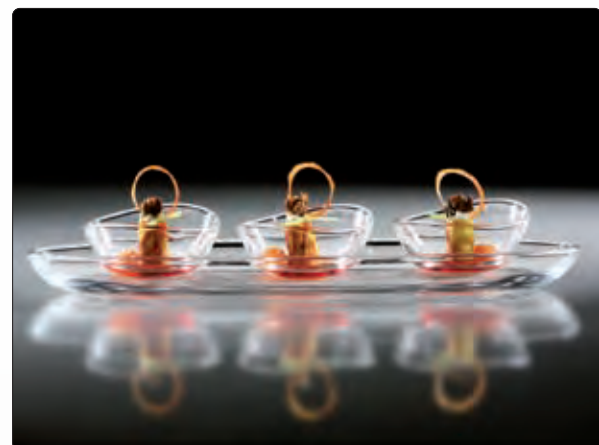

small butter & lard pot

clear glass, round

item	Ø in cm	height in cm	PU
5424	9	9.5	6 pcs



glass bowl

clear glass, oval

item	Ø / height in cm	content in l	PU
5330.08	7.5/3.5	0.08	6 pcs



glass miniature

clear glass, for bridges "Modul" items 4584 and 4724

item	Ø / height in cm	content in l	PU
5257	7/10	0.08	12 pcs



glass miniature

clear glass, for bridges "Modul" items 4584 and 4724

item	Ø / height in cm	content in l	PU
5405	5/8.6	0.1	6 pcs



glass bowl

clear glass, square

item	l x w x h in cm	content in l	PU
5308.08	8x8x4.5	0.14	6 pcs
5308.11	11x11x6	0.3	6 pcs



→ Melamine tray 4593 | p. 290



small glass creamer

clear glass, handblown

item	Ø / height in cm	content in l	PU
5416	4.7/9.8	approx. 0.1	6 pcs



glass bowl

clear glass, oval

item	l x w x h in cm	content in l	PU
5444	12.5x7x4	0.08	6 pcs



→ Stainless steel cruet stands | p. 282/283



small bowl
china, white

item	Ø / height in cm	content in l	PU
4498	8/6	0.17	6 pcs



small bowl "Catering"
china, white

item	Ø / height in cm	content in l	PU
4499	8/5.5	0.2	6 pcs



→ Trays "Modul" | p. 150



→ Melamine tray 4593 | p. 290



miniature
china, white, stackable

item	Ø / height in cm	content in l	PU
4490	5.1/7	0.1	6 pcs



bowl "Modul"

china, white, square, deep, for base trays "Modul" made of walnut and melamine

item	l x w in cm	content in l	PU
4381	11x11	0.07	12 pcs



plate "Modul"

china, white, rectangular, flat, for base trays "Modul" made of walnut and melamine

item	l x w in cm	PU
4383	22x11	12 pcs



plate

china, round, flat, Ø 17 cm

item	colour	PU
4606.17	white, glossy	4 pcs
4607.17	black, matt	4 pcs



bowl
china, white, oval

item	l x w x h in cm	content in l	PU
4081.12	12.5x7.5x4	0.1	12 pcs



plateau plate "DressCoat"

china, white, useable area (plateau): Ø 7.5 cm, also useable as a bowl

item	Ø / height in cm	content in l	PU
4386.01	9/4.5	0.1	12 pcs



small creamer
china, white

item	l x w x h in cm	content in l	PU
4093	8.2x5.8x4.2	0.07	12 pcs



amuse gueule/tapas spoon
china, white

item	l x w x h in cm	PU
4260.01	13x4x3	12 pcs



miniature plate

china, round, flat, Ø 10.5 cm

item	colour	PU
4606.10	white, glossy	12 pcs
4607.10	black, matt	12 pcs



→ Spoon rests | p. 142

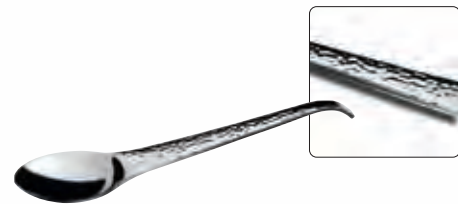

party spoon

stainless steel 18/10, 4.3 mm thick, heavy quality, 21 cm long

item	version
1938.01	hammered



bowl "Artisan"

stainless steel 18/10, inside polished, outside matt finish, round, hammered rim with golden adornment (brass)

item	Ø in cm	height in cm	content in l
2371.07	7.5	3.5	approx. 0.1
2371.11	11	5.5	approx. 0.3



tray

stainless steel 18/10, polished, for e.g. Darbo portion jam (28 g and 40 g), portion ketchup or mustard

item	version	l x w in cm
2191.03	3 holes (Ø 4.5 cm)	19.5x7.5
2191.04	4 holes (Ø 4.5 cm)	24x7.5



skewer

stainless steel 18/10, polished, 24 cm long

item	version	PU
1939.01	Moon	12 pcs

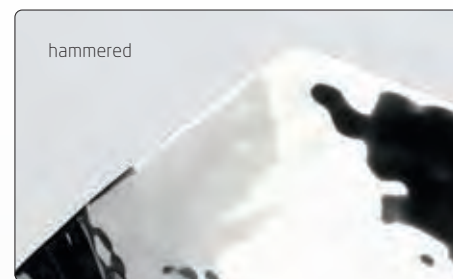

bowl

massive stainless steel 18/10, triangular, hammered, polished

item	Ø in cm	height in cm	content in l
2180.09	9	4	0.08
2180.13	13	6	0.28



amuse-gueule stand with foot

massive stainless steel 18/10, polished

item	l x w x h in cm
2204.08	11.5x9.5x8.5
2204.11	11.5x9.5x11.5

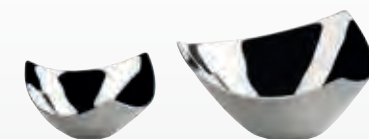
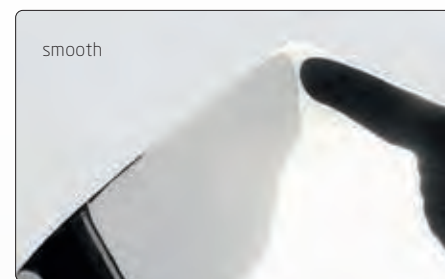

bowl

massive stainless steel 18/10, triangular, smooth finish, polished

item	Ø in cm	height in cm	content in l
2182.09	9	4	0.08
2182.13	13	6	0.28



→ More sizes | p. 83



etagere

massive stainless steel 18/10, triangular, smooth finish, polished, not demountable

item	Ø in cm	height in cm
2187	13	16.5

ice cream cup with foot

massive stainless steel 18/10, hammered, polished

item	l x w x h in cm	content in l
2207.11	11.5x10x11	0.15
2207.15	13.5x11x15	0.25



Please note:

Positioning of plateau plates with the same height is only possible to a limited extend.



miniature plate with rod

massive stainless steel 18/10, hammered, polished, plate approx. 9x8 cm, for slate platters 8054 and 8056

item	height in cm
2203.08	8
2203.13	13
2203.18	18
2203.23	23

→ Suitable inserts | p. 104



skewer

stainless steel 18/10, polished, 24 cm long

item	version	PU
1939.01	Moon	12 pcs



holder coil shape

massive stainless steel 18/10, hammered, polished, for inserts made of china and glass, suitable for slate platters items 8054 and 8056

item	Ø in cm	total height in cm
2167.15	5.5	20
2167.20	5.5	25
2167.25	5.5	30
2167.30	5.5	35



Slate is a unique and exceptional natural product. The surfaces of our slate platters have the typical slaty cleavages, therefore every piece is unique. Small deviations in structure, thickness and weight of the plates cannot be avoided because of the nature of the product. There may be single inclusions of other minerals and fossils. These extraordinary features give slate its precious and vivid appearance. Please note: Specific groceries, especially those that contain fruit acid (citric acid), may damage the surface in case of longer contact. Therefore we recommend avoiding direct contact with edibles.

These slate plates are unsealed. In order to give them an evenly dark grey colour and to freshen up the surface, we recommend rubbing the plates with some vegetable oil from time to time.



platter, slate

natural slate, not sealed, rectangular, with 3 holes (Ø 5 mm), with 4 feet of felt (not dishwasher-safe), for holder coil shape items 2167.. or skewer item 1939.01 or miniature plates items 2203... (please order separately)

item	l x w x h in cm
8054	30x10x2.5

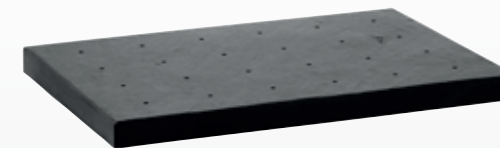

platter, slate

natural slate, not sealed, rectangular, with 24 holes (Ø 5 mm), with 4 feet of felt (not dishwasher-safe), for holder coil shape items 2167.. or skewer item 1939.01 or miniature plates items 2203... (please order separately)

item	l x w x h in cm
8056	45x31x3



Item 8051: Drilled holes Ø 3 mm: suitable for usual skewers made of wood



skewer plate, slate

natural slate, not sealed, rectangular, double, with 35 holes (Ø 3 mm), with 6 feet of felt (not dishwasher-safe)

item	l x w x h in cm
8051	35x25x2.6



→ Suitable melamine trays | p. 143



Please note:

Items made of melamine are not to be used for cooking in microwave and combi steam oven!

Cleaning in the dishwasher is possible up to a maximum water temperature of 70 degrees.



cutlery/napkin box

melamine, black, stackable, surface matt, food-safe, with 4 rubber feet, not suitable for microwave and combi steam oven, for cocktail napkins folded to 1/8

item	l x w x h in cm	content in l	PU
4591	16x6x4.5	0.26	2 pcs

insert/box

melamine, black, surface matt, stackable, food-safe, not suitable for microwave and combi steam oven, up to 4 pieces fit into item 4578

item	l x w x h in cm	PU
4580	29.5x9x3.3	3 pcs

bowl/box

melamine, black, surface matt, food-safe, not suitable for microwave and combi steam oven

item	l x w x h in cm	content in l	PU
4598.09	9x6.3x4.5	0.25	6 pcs
4598.13	12.8x9x4.5	0.35	4 pcs

bowl/box

melamine, black, surface matt, food-safe, not suitable for microwave and combi steam oven

item	l x w x h in cm	content in l	PU
4599.13	12.8x12.8x4.5	0.51	4 pcs

Cruet stands,
trays,
etageres



"Bento Box" – flexible mobility



Please note:

Items made of melamine are not to be used for cooking in microwave and combi steam oven!

Cleaning in the dishwasher is possible up to a maximum water temperature of 70 degrees.



Serving guests at the pool, beach or on the terrace is often associated with longer walking distances for service staff. The "Bento Box" from Zieher has been designed especially for these requirements – all components are stackable. This way, a space-saving storage and a comfortable, non-slip transport, even with several dishes at the same time, is guaranteed.

The versatility of the individual components also becomes evident in the cover. This lid can also be used as a tray, whose lightly textured inside has an anti-slip effect.

All information about the "Bento Box" can be found on page 141.

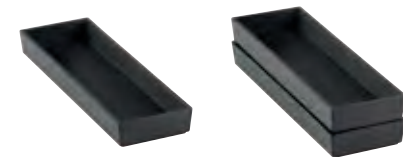

insert/box

melamine, black, surface matt, stackable, food-safe, not suitable for microwave and combi steam oven, up to 4 pieces fit into item 4578

item	l x w x h in cm	PU
4580	29.5x9x3.3	3 pcs



Bento Box

melamine, black, surface matt, stackable, food-safe, not suitable for microwave and combi steam oven, partition for cutlery/napkin/inserts (28 cm x 7.5 cm) or for platters (28 cm x 28 cm)

item	l x w x h in cm
4578	39x30.5x8.5



lid/tray

melamine, black, surface matt, stackable, food-safe, not suitable for microwave and combi steam oven, with ventilation slots, suitable for item 4578, also usable as a tray

item	l x w x h in cm
4579	39.5x31.5x4



The room service tray as well as the bed tray stand out due to the precious walnut wood, which is incorporated into these products with high-quality craftsmanship. The recessed longside enables comfortable dining directly off the tray.

The retractable feet of the bed tray have been constructed in a very stable way and are securely kept in position by integrated magnets when folded in. The height of the erected tray has been chosen in a way that, even with soft mattresses, a comfortable sitting beneath the tray is guaranteed. So start off the day with a boundlessly relaxing breakfast in bed!



bed tray "Solid"

walnut, food-safe sealed, not dishwasher-safe, stackable, with feet, 2 handles, recessed on one side of the rim

item	l x w x h in cm (closed)	l x w x h in cm (set up)
4773	60x40x6.5	approx. 74x40x31



Please note:

All items made of walnut are not dishwasher-safe! Do not immerse in water!

→ Stand for roomservice tray 4735 | p. 299



Information icon (i in a circle) Rubber feet at the bottom which are slightly offset towards the middle enable the transport in a tray trolley in 1/1 EN-format 60 cm x 40 cm.



room service tray "Solid"

walnut, food-safe sealed, not dishwasher-safe, stackable, recessed on one side of the rim, with 2 handles, with 4 rubber feet, suitable for tray stand "Solid" item 4748

item	l x w x h in cm
4735	60x40x5.4

“Solid”



This service tray with integrated separations is perfectly suitable for the service of small dishes at the pool, the beach or in the room. The major compartment has been designed for plates with a max. diameter of up to 29 cm, the lateral separation offers sufficient space for cutlery and napkin. Also insertion bowls with a max. width of 7.5 cm will find space and thus can be used for dips, salad and other side dishes. You will find a selection of suitable inserts on page 289. The trays are equipped with integrated grip holes and are stackable. Finger joints at the corners, non-skid rubber feet and a food-safe sealing of the solid walnut wood fulfill the high-quality standards, which are valid for all items of the “Solid” range.



serving tray “Solid”

walnut, food-safe sealed, not dishwasher-safe, stackable, 2 compartments: 30 cm x 30 cm and 30 cm x 8 cm (for cutlery or china/glass bowls), with 4 rubber feet

item	l x w x h in cm
4769	41.7x32.5x6.7



→ Serving tray 4707 | p. 257



→ Boxes made of walnut and other items for the hotel room | from p. 297



serving tray “Solid”

walnut, food-safe sealed, not dishwasher-safe, with 4 rubber feet

item	l x w x h in cm	l x w in cm (inside)
4713	34x34x3	32x32

“Solid”



4707 + 1668.03



serving tray “Solid”

walnut, flat, food-safe sealed, not dishwasher-safe, with 2 recessed grips, with 4 rubber feet

item	l x w x h in cm	l x w (inside) in cm
4707	53x37x4	50.2x34.2



serving tray “Solid”

walnut, deep, food-safe sealed, not dishwasher-safe, 2 recessed grips, with 4 rubber feet

item	l x w x h in cm	l x w (inside) in cm
4740	53x37x10	50.2x34.2



glass platter

special hardened safety glass, 4 mm thick, rectangular, rounded edges, polished rim, dishwasher-safe, rubber feet included (adhesive), underside scratch-proof, for serving tray “Solid” items 4707 and 4740

item	version	l x w in cm
1668.03	black glass	50x34



→ Suitable displays and various accessories | p. 128

"Solid" – Enjoyment in a pentagon



These classy service platters take effect by their exceptional shape and the stylish combination of oiled walnut wood and slate-grey ceramics.

Available in two different sizes for just one or more persons, single courses right up to mixed arrangements - so-called "sharing plates" - can be staged appealingly. For bigger buffet setups, several plates can be arranged to save space and thus provide an extraordinary structuring of the buffet areas. The pentagonal design allows numerous arrangements and enables beautiful presentation areas on the buffet.

The projecting handle permits an easy removal of the insert and thus allows an uncomplicated cleaning of the thin but very robust ceramic.

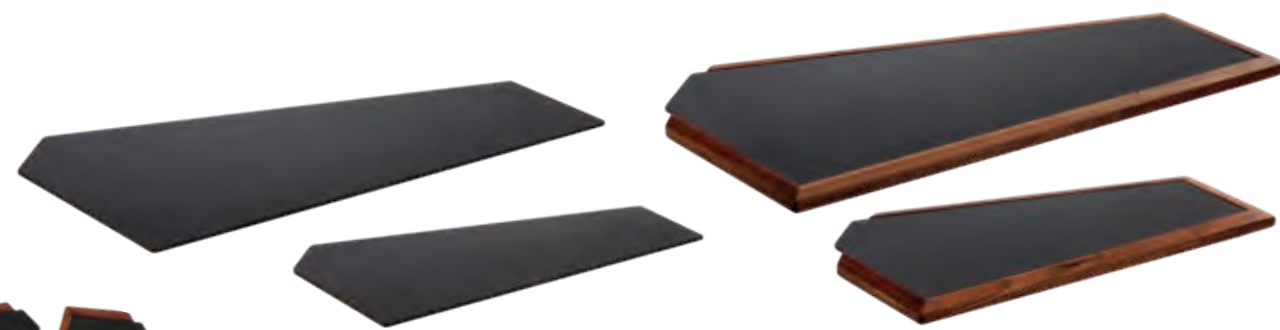
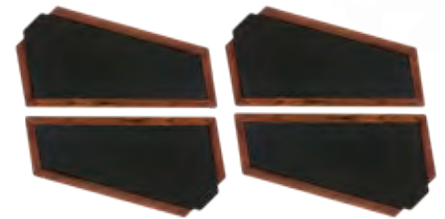

insert/platter

coloured ceramic, 6 mm thick, black, dishwasher-safe

item	l x w in cm
4780.46S	39x19.5
4780.67S	59x29

serving tray "Solid"

walnut, oiled, not dishwasher-safe, with changeable insert made of black coloured ceramic

item	l x w in cm
4780.46	46.5x23
4780.67	67.5x33

Serving platters made of walnut

"Connect!"



"Connect!" convinces as an extremely versatile tool such as a snack board, serving or cutting board, or as a presentation platter created by the combination of several elements.

The integrated tenon in the shape of a dovetail serves as a decorative handle with an artisanal touch. Suitable cutouts at the underside allow an easy combination of different elements. Skid-proof positioning feet ensure a firm stand, the slanted outer edges facilitate handling. The solid walnut wood is sealed with high-quality oils, which makes it easy to freshen up the surface from traces of everyday wear and tear.



cutting/snack board "Connect!"

walnut, oiled, not dishwasher-safe, pluggable, with handle, with 4 rubber feet

item	l x w x h in cm	length incl. handle
4775.44PB	40x16x2.3	44.5



cutting/snack board "Connect!"

walnut, oiled, not dishwasher-safe, pluggable, with handle, with 4 rubber feet

item	l x w x h in cm	length incl. handle
4774.31PB	26.5x20x2.3	31



Please note the care instructions: not dishwasher-safe, do not immerse in water!

“Solid”



The bread baskets made of solid walnut wood surprise with their exceptional design and their highly sophisticated handcraft. Designing these bowls, the Milanese designer Itamar Harari did not only think of serving bread, but also of the typical Italian Grissini. Recesses at both ends are especially suitable for those. A selection of fruit in the hotel room also receives much attention if stylishly presented in these extraordinary bowls made of beautiful wood.

Design: Itamar Harari



glass cloche

borosilicate glass, clear, handblown, handmade, for saucer “Solid” item 4700...

item	Ø in cm	height in cm
4982.09	9	approx. 14-16
4982	13	approx. 20-23



coaster/glass insert

clear glass, 4 mm thick, round, edge polished and deburred, with 4 transparent silicone feet, for coaster “Solid” item 4700

item	Ø in cm	PU
5244	13	6 pcs



coaster “Solid”

walnut, food-safe sealed, not dishwasher-safe, for glass cloche items 4982... and glass insert items 5244...

item	Ø / height in cm	Ø inner circle in cm
4700.01	15.3/2	9.3
4700	22/2	13.3



glass cloche

borosilicate glass, transparent, handblown, handmade, for coaster “Solid” items 4734...

item	Ø in cm	height in cm
4880.18	18.5	approx. 29-32
4880.22	22.5	approx. 35-38
4880.26	26	approx. 41-44
4880.30	30	approx. 48-51



coaster/glass insert

clear glass, 4 mm thick, round, edge polished and deburred, with 4 transparent silicone feet

item	Ø in cm	for coaster “Solid” item
5244.17	16.7	4734.01
5244.21	20.7	4734.02
5244.24	24.2	4734.03
5244.28	28.2	4734.04



coaster “Solid”

walnut, food-safe sealed, not dishwasher-safe, stackable, for glass cloche items 4848, 4850, 4851, 4852 and 4880... and glass inserts items 5244...

item	Ø / height in cm	for cloches / inlays
4734.01	23/3	Ø 18.5/16.7 cm
4734.02	27/3	Ø 22.5/20.7 cm
4734.03	30.5/3	Ø 26/24.2 cm
4734.04	34.5/3	Ø 30/28.2 cm

“Solid”



glass cloche/wine cooler

clear glass, handblown, reinforced version, with round handle, for coaster “Solid” item 4734.02 (as cloche) and wine cooler stand item 2220.70 (as wine cooler)

item	Ø in cm	height in cm
4848	22.5	26



glass cloche

clear glass, handblown, with round handle, for coaster “Solid” items 4734...

item	Ø in cm	height in cm
4850	18.5	31
4851	22.5	37
4852	26	43



bread basket “Solid”

walnut, food-safe sealed, not dishwasher-safe, boat-shaped

item	l x w x h in cm
4770.24	24.5x12x5



card holder

walnut, varnished, slot 2 mm wide

item	l x w x h in cm	PU
4726	8x3x3	4 pcs





Solid wood from the walnut tree, which is one of the most precious and most beautiful types of wood, forms the basis for this series. The high-quality workmanship in combination with the food-safe sealing guarantees long durability, even in daily use. Please note the enclosed care instructions: The products are not dishwasher-safe, do not immerse in water!



Item 4720: Stackable in all commercial transport boxes in format 60 cm x 40 cm



cutlery/napkin box "Solid"

walnut, food-safe sealed, not dishwasher-safe, with rubber feet in the lid (soft closure, can be opened to an angle of 90° only), with black felt insert, stainless steel platter with space for an engraving (price and quantity upon request), height with open lid: 15.5 cm

item	l x w x h in cm	size inside in cm
4766	28.8x11.8x6	26x8.7

cutlery box "Solid"

walnut, food-safe sealed, not dishwasher-safe, with acrylic glass lid, with 4 rubber feet, for cutlery with a length of up to 24.3 cm

item	l x w x h in cm
4720	26.5x16.2x8



→ Suitable inserts (4.9 x 4.9 cm) | p. 288



glass insert/coaster

clear glass, with 4 transparent rubber feet, for tray "Solid" item 4708

item	l x w x h in cm	PU
4708.G	20.7x5.1x0.4	2 pcs



tray "Solid"

walnut, food-safe sealed, not dishwasher-safe, with 4 rubber feet, for china/glass bowls 4.9 cm long and 4.9 cm wide

item	l x w x h in cm
4719	15.2x15.2x2.5



tray "Solid"

walnut wood, sealed food safe, not dishwasher-safe, for glass insert item 4708.G (please order separately)

item	l x w x h in cm	l x w (inside) in cm
4708	25.8x10.2x2	20.8x5.2



box "Solid"

walnut, food-safe sealed, not dishwasher-safe, with 4 rubber feet, 2 compartments: 10.4 cm x 5.2 cm and 10.4 cm x 16.6 cm, for china/glass bowls 4.9 cm long and 4.9 cm wide

item	l x w x h in cm
4703	24.4x12.4x4



“Solid”



Food & Design: Marco D'Andrea
www.marcodandrea.de
Instagram: marco.dandrea.pastry

Finest creations of the pâtisserie have to be presented in a worthy frame!



Marco D'Andrea:

“The round deepenings in this presenting box are specifically matched, that even if the box is inclined, the truffles will not roll out. Chocolates/truffles with a diameter ranging from 22 to 28 mm fit easily into the deepenings. The dark wood of the walnut tree gives the box a fine and modern look.

The tinted glass reveals the secrets hidden inside the box only once it is given a very close look. The glass can be inserted vertically into the back part of the box or can be slid in under the box. Once closed, anything inside the box can be stored hygienically. The narrow, sidelong compartment in each box can be used individually. Besides placing a tong or other serving cutlery, it can also be used for the presentation of more chocolates or petit fours.”

The idea and design for these presentation boxes “Solid” for truffles and filled chocolates are from Marco D'Andrea, “Junger Wilder 2012” and proclaimed “Pâtissier of the year 2014” during the “Leaders of the Year Award” convention (powered by ROLLING PIN). His first cookbook “Modern TeaTime” was published by Südwest Verlag in autumn 2021.

Further awards:

“Pâtissier of the year 2019” – Rolling Pin

“Pâtissier of the year 2020” – Gault Millau

“Pâtisserie team of the year 2020” – Schlemmer Atlas



Please note:

The maximum filling height of the side compartment is 26 mm (when lid is closed).



chocolate/ice cube tongs

massive stainless steel 18/10, hammered, polished

item	length in cm
2138	19

chocolate/truffle box “Solid”

walnut, food-safe sealed, not dishwasher-safe, with tinted glass lid (can be used as rear wall or to slide in on the bottom side), square, 2 compartments: 1st compartment with 24 cavities for chocolates, 2nd compartment 21.3 cm x 6 cm

item	l x w x h in cm
4737	23.8x23.8x6

chocolate/truffle box “Solid”

walnut, food-safe sealed, not dishwasher-safe, with tinted glass lid (can be used as rear wall or to slide in on the bottom side), rectangular, 2 compartments: 1st compartment with 48 cavities for chocolates, 2nd compartment 21.3 cm x 6 cm

item	l x w x h in cm
4738	36.8x23.8x6



Delicacies in delicate settings!

Due to the comprehensive range of accessories, the “Solid” presentation box offers multiple application possibilities. The box, regularly fitted with a wooden sliding lid, can be equipped with several optionally available inserts made of top-quality solid surface material. Apart from an insert with round cavities for nine truffles/chocolates and a flat plate that can be used for layered chocolates, various little somethings or amuse bouches, there is also an insert available for commercial coffee capsules. The insert for cigars can hold up to four cigars and a separate compartment aside offers additional space for matches, cigar cutters, etc. The lid made of tinted glass, which is also available, sets the scene for what is being presented.



1

storage/presentation box “Solid”

walnut, food-safe sealed, not dishwasher-safe, with sliding lid made of wood, also useable with glass lid item 4762.18G (please order separately)

item	l x w x h in cm	size inside in cm
4762.18	18x18x6	approx. 16x16x4.2

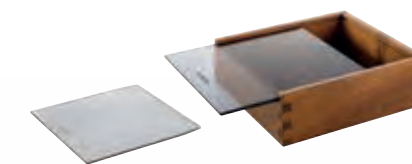

2

glass lid

hardened glass, grey tinted, with recess, for storage/presentation box “Solid” item 4762.18

item	l x w in cm
4762.18G	17.3x16.7



3

insert for cigars

solid surface material, black, for 4 cigars (grooves 1.9 cm wide), storage area for accessories (14.8 cm x 4.8 cm), for storage/presentation box “Solid” item 4762.18

item	l x w x h in cm
4763.02S	15.8x15.8x1



4

insert/platter

solid surface material, white, usable area: 14.8 cm x 14.8 cm, for storage/presentation box “Solid” item 4762.18

item	l x w x h in cm
4763.04W	15.8x15.8x1



1+2+5

1+2+6

5

insert for chocolates

solid surface material, with 9 cavities (Ø 2.2 cm), for storage/presentation box “Solid” item 4762.18

item	colour	l x w x h in cm
4763.01S	black	15.8x15.8x1
4763.01W	white	15.8x15.8x1

6

insert for coffee capsules

solid surface material, black, with 6 cavities (Ø 3.8 cm), storage area for accessories (14.8 cm x 4.8 cm), for storage/presentation box “Solid” item 4762.18

item	l x w x h in cm
4763.03S	15.8x15.8x1



Massive brass, produced in traditional sand casting, creates unique sculptural items, which enthrall especially by their contrast between matt golden surfaces and dark patination.

An interesting add-on to the "Fakir" bowls are round glass platters of the Zieher product range. These can be laid on easily and thus generate the option to use the impressive objects on both sides.

→ "Stompl" | p. 16

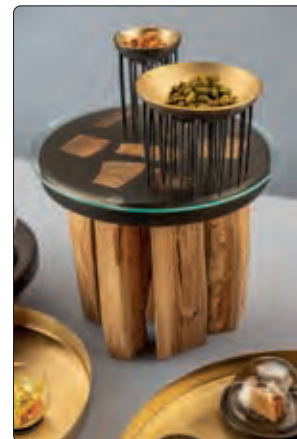

Please note:

Brass items are only suitable for cold/dry food. Do not clean in the dishwasher.



coaster/glass insert

clear glass, 4 mm thick, edges polished and deburred, with 4 transparent rubber feet

item	Ø in cm	PU
5244	13	6 pcs
5244.17	16.7	1 pc
5244.21	20.7	1 pc
5244.24	24.2	1 pc
5244.28	28.2	1 pc



bowl/display "Fakir"

brass, inside golden (transparent coating, food-safe), outside dark patinated, not dishwasher-safe

item	Ø in cm	height in cm
2380.07	7.5	11
2380.12	12.5	10
2380.15	15	8.5
2380.18	18	9.5

The service trays "Orbis" are made of solid brass and furnished with a matt surface structure. The modern appearance of these products results from the matt-golden tint and the reduced creation. The trays are available in two sizes and predestined for the use in a bar, on the buffet or the service in a restaurant.

All trays are food-safe sealed, nevertheless the direct contact with food should be avoided. Primarily, the varnishing prevents from too rapid formation of patina, which is inevitable for brass. In the long term, this patina is actually desired as it is exactly this matured colour, occurring in the course of time and use, which exudes a very special charm. By and by, these trays become more and more beautiful, each piece evolves into a unique copy.



patina



Please note:

Brass items are only suitable for cold/dry food. Do not clean in the dishwasher.



serving tray "Orbis"

brass (transparent coating, food-safe), not dishwasher-safe

item	Ø in cm	height in cm
2378.30	30	3
2378.40	40	3

→ "Bosque" | p. 156



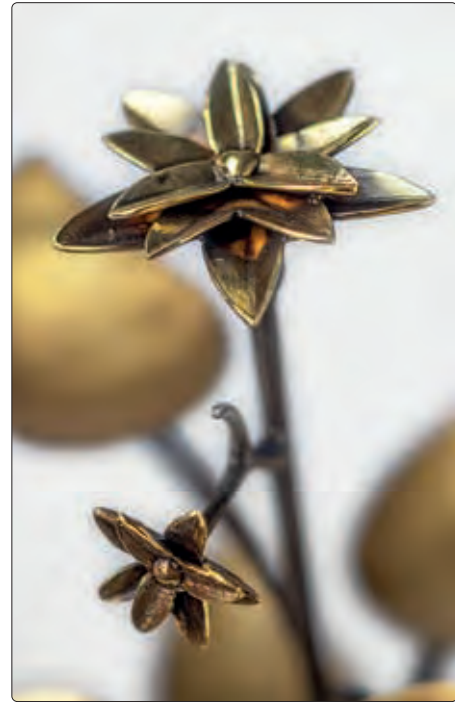

Please note:

All items of the "Fleur Déco" series are food-safe, allowing for the direct placement of cold and dry foods on the etagere. For other purposes Zieher offers a wide selection of bowls as well as matching plates and dishes. Do not clean in the dishwasher.

The "Fleur Déco" series embodies the true essence of luxury combined with elegance, while simultaneously paying homage to the art of artisanal craftsmanship.

It is the perfect choice for discerning hosts who value exceptional quality and design and who place a high emphasis on both the taste and presentation of their culinary creations.

"Fleur Déco" is entirely crafted from brass and includes a three-tiered etagere for plates and platters, a serving platter and a floral-designed buffet tree. You can find all the information about the series on pages 96 to 99.



coaster/glass insert
clear glass, 4 mm thick, round, edge polished and deburred, with 4 transparent silicone feet

item	Ø in cm	PU
5244.21	20.7	1 pc



coup plate "Bolla"
glass, structured, round

item	Ø in cm	PU
5186.22	21.5	6 pcs



plate "Bosque"
stoneware, green, glossy glazed (reactive glaze), flat, organically shaped

item	l x w in cm	PU
4544.20	20 x 17	6 pcs



plate "Sombre"
china, matt black, round, flat, organic shape

item	Ø in cm	PU
3967.20S	20	12 pcs



etagere "Fleur Déco"
brass, golden/antique (transparent coating, food-safe), Ø bottom plate 22 cm, with 10 miniature plates (approx. 13 cm x 8 cm), not dishwasher-safe

item	Ø in cm	height in cm
2388.10	40	approx. 47.5

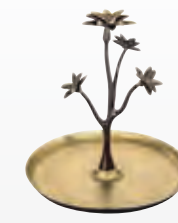

serving tray/platter "Fleur Déco"
brass, golden/antique (transparent coating, food-safe), Ø bottom plate 22 cm, not dishwasher-safe

item	Ø in cm	height in cm
2389	22	approx. 24



etagere "Fleur Déco"
brass, golden/antique (transparent coating, food-safe), with 3 levels (Ø inside: 23 cm), not dishwasher-safe

item	Ø in cm	height in cm
2387	36	approx. 55

"Table-Tree"



Tempting variety on the buffet

For the presentation of filigree delicacies in the smallest of spaces, the new "Table-Trees" offer numerous possibilities for a stylish staging.

A selection of fruit, chocolates or patisserie can be presented on the six organically shaped petals of the "Table-Tree" Flower. The "Table-Tree" Pin offers the possibility of presenting finger food or small snacks on six skewers at different heights. Each delicacy is held securely by an artfully shaped spiral that prevents from slipping.

The 30 cm high "Table-Trees" are made entirely of stainless steel by hand and polished to a high gloss. The solid base forms the basis of these filigree products and ensures a secure stand.



Anti-slip-pads for "Flex-Tree"



coaster

silicone, Ø 5 cm, 3 mm thick, temperature resistant (-40 °C to +230 °C), food-safe, with rim on one side, for anti-slip placement of miniatures

item	colour	PU
4661.05S	black	24 pcs
4661.05W	white	24 pcs

A tree to dream of!

On 13 resp. 25 levels, these trees offer the possibility to present and showcase finger food, petit-fours and other delicacies.

The "Flex-Tree" enthuses by its versatility! It can be equipped with various miniatures. You can find a small selection and all information about these etageres on page 100.

The leaves shape of the "Flower-Tree" is based on the already existing plateau plates and "Flower-Tower" etageres (page 103 and 104). Especially on the buffet, this opens up the option to arrange installations diversified but yet harmonious and variable.

"Flex-Tree" & "Flower-Tree"



etagere "Table-Tree" Flower

massive stainless steel 18/10, smooth finish, polished, Ø 29 cm, with miniature plates (approx. 9 cm x 7.5 cm)

item	Ø in cm	height in cm	number of levels
2208.06	29	30	6



etagere "Table-Tree" Pin

massive stainless steel 18/10, smooth finish, polished, Ø15 cm, with skewers and stoppers

item	Ø in cm	height in cm	number of levels
2210.06	15	30	6



etagere "Flex-Tree"

massive stainless steel 18/10, smooth finish, polished, Ø 24 cm, with round discs (Ø 5.5 cm)

item	height	number of levels
2209.13	53	13
2209.25	72	25

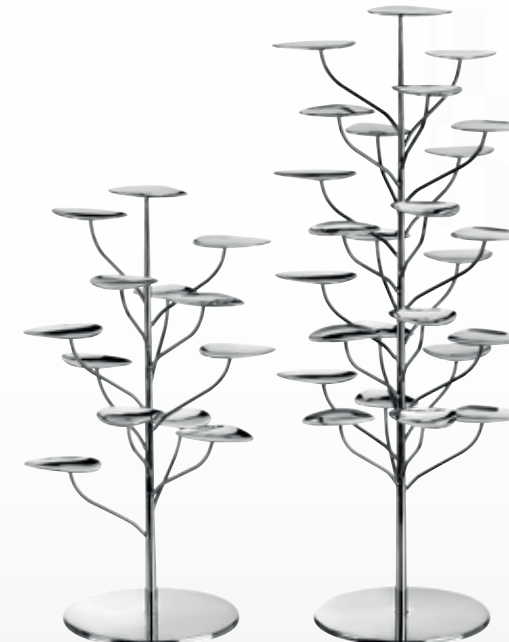

etagere "Flower-Tree"

massive stainless steel 18/10, smooth finish, polished, Ø 29 cm, with miniature plates (approx. 9 cm x 7.5 cm)

item	height in cm	number of levels
2208.13	51.5	13
2208.25	71	25



"Flower Tower"



Floral shapes in a steely gloss

Two etageres as well as plateau plates in different heights (page 250) allow a visually harmonious yet flexible and diversified presentation of appetizers, finger-foods or desserts. The ice cream/sorbet cups and petit-fours stands in various sizes make a nice complement and individually stage petit fours and more.

The formal base for all products is a slightly arched and kidney-shaped miniature plate. On three levels, the buffet etagere combines seven small plates each to a presentation platform of floral appearance and offers space to present up to 21 delicacies in a compact and stylish way.

The table etagere consists of one level only and is therefore perfectly suitable for the restaurant service to present intermediate courses, antipasti or dessert variations. This product is the ideal choice, even as a stylish storage dish for different types of fruit or accessories of daily use.

Design: Itamar Harari



etagere with 3 tiers
massive stainless steel 18/10, hammered finish, polished, 21 miniature plates (approx. 9 cm x 8 cm)

item	Ø in cm	height in cm
2201	25	44.5

etagere with 1 tier
massive stainless steel 18/10, hammered, polished, 7 miniature plates (approx. 9 cm x 8 cm)

item	Ø in cm	height in cm
2202	25	9

ice cream cup with foot
massive stainless steel 18/10, hammered, polished

item	l x w x h in cm	content in l
220711	11.5x10x11	0.15
220715	13.5x11x15	0.25

amuse gueule stand with foot
massive stainless steel 18/10, polished

item	l x w x h in cm
2204.08	11.5x9.5x8.5
2204.11	11.5x9.5x11.5



→ "Gelo" | p. 160



→ Cloches 4982 + 4982.09 | p. 260
→ China plates 4607.10 + 4607.17 | p. 247



→ Glass bowl 4814.17 | p. 232
→ Cloche 4940.08 | p. 235



→ "DressCoat" 4388 | p. 182



→ China plate 4607.17 | p. 247
→ Cloche 4940.08 | p. 235

"DryPod"

Primarily, "DryPod" is a dry rack for decanters.

The solid structure made of brushed stainless steel, refined in either black or brass colour, forms the basis for this shapely product.

Also besides its actual determination, "DryPod" is tempting by its versatility. As an etagere on the laid table or in the hotel room, the rack can be equipped with numerous other Zieher articles and thus presents food and delicacies in an impressive way.

Please find all information about "DryPod" on pages 222/223.



decanter dry rack/display "DryPod"

massive stainless steel 18/10, brushed, pvd-coated, with 3 anti-slip rubber feet (not dishwasher-safe), suitable for all Zieher decanters

item	Ø in cm	height in cm	colour
2230	18	26	brass
2232	18	26	black



drip tray

resin, anthracite, matt, translucent, not dishwasher-safe, suitable for decanter dry rack "DryPod" items 2230 and 2232

item	Ø in cm	height in cm
7030	12.5	1

Fig. from bottom



→ "Sombre" | p. 162



→ Toast stand | p. 120



Elegantly served and presented in style – classic plate etageres, newly inspired!

Shapely and individual stands by Zieher are suitable for numerous applications. The classic plate etageres are available with three levels and in two sizes. The classic mini format etageres effectively present petit fours, chocolates or other delicacies (page 274). The larger version is ideal for scones and jam during Five o’Clock Tea, but also a choice of cold cuts, cheese or fruit can be staged elaborately on the set table.



Tilttable handle



miniature plate

china, round, flat, Ø 10.5 cm

item	colour	PU
4606.10	white, glossy	12 pcs
4607.10	black, matt	12 pcs



etagere

massive stainless steel 18/10, hammered, polished, with 3 insertion levels (Ø inside: 6.5 cm) for plates/bowls with max. Ø 11 cm

item	l x w x h in cm	levels
210703	12.5x11.5x23	3



etagere

massive stainless steel 18/10, hammered finish, polished, with 3 insertion levels (Ø inside: 10.8 cm) for plates/bowls with max. Ø 17.5 cm

item	l x w x h in cm	levels
2105.03	20.5x18x37.5	3



plate

china, round, flat, Ø 17 cm

item	colour	PU
4606.17	white, glossy	4 pcs
4607.17	black, matt	4 pcs



tray

massive stainless steel 18/10, square, hammered, polished, with feet

item	l x w x h in cm
2101.17	17.5x17.5x2.3



glass plate "Unique"

glass, white marbled, bottom satined, round

item	Ø in cm	PU
5178.16	16.5	6 pcs

tray
massive stainless steel 18/10, rectangular, hammered, polished, with feet, for etagere item 2110

item	l x w x h in cm
2110.01	30x8x3

etagere

massive stainless steel 18/10, hammered, polished, including 3 removable trays item 2110.01 (30 cm long, 8 cm wide, 3 cm high)

item	l x w x h in cm (etagere only)
2110	11.5x11.5x39 (height without handle)

"Five o'Clock Tea"



→ Etageres "Stablo" | p. 110

The etagere with three tiers, made of hammered and highly polished stainless steel, forms an extravagant basis for many sorts of plates and platters. Black silicone rings keep inserted porcelain in position and prevent annoying noises.

A very special aesthetic setup can be arranged by using a combination of several etageres along with the biggest plates of the "DressCoat" series. In connection with the almost invisible tier stand, the plateau plates appear amazingly airy and playful by their floating look-and-feel. Even in the hotel room, the etageres can be positioned in an eye-catching way. Equipped with "DressCoat" or other tableware, small snacks, a selection of fruit or a sweet welcoming treat can be staged in an appealing way. All information about this etagere are available on page 94.



anti-slip rings

Please note:



We recommend the use of large plates on the lower level only.

Etagere "DressCoat"



etagere "DressCoat"
massive stainless steel 18/10, hammered, polished, 3-armed

item	Ø in cm	height in cm
2212.30	36	30

glass plate "Unique"
glass, white marbled, bottom satined, round

item	Ø in cm	PU
5178.21	21	6 pcs
5178.28	28	6 pcs

plateau plate "DressCoat"

white china, useable area (plateau): Ø 19.5 cm, also useable as a bowl

item	Ø / height in cm	content in l	PU
4388	22/6.5	0.9	3 pcs



→ Triangular bowls | p. 248



etagere

massive stainless steel 18/10, triangular, smooth finish, polished, not demountable

item	Ø in cm	height in cm
2187	13	16.5



etagere/pastry stand

massive stainless steel 18/10, smooth finish, polished, 4-armed (6 cm distance between the trays), not demountable

item	Ø trays in cm	height in cm
2189	2x14/2x18	25





i Anti-slip sleeves provide a safe positioning of buffet platters.



i The "Falcon" etagere - as most stainless steel items - can be refined by using the PVD process. Prices, minimum order quantities and delivery times upon request.



buffet platter, black glass

special hardened safety glass, 4 mm thick, black, rounded edges, polished rim, dishwasher-safe, rubber feet included (adhesive), underside scratch-proof

item	version	l x w in cm
1658.08	rectangular	80x21
1668.22	rectangular	91x21
1668.24	rectangular	102x21



buffet platter, laminated plastic

laminated plastic, 8 mm thick, dark grey, black intermediate ply, break-proof, scratch-proof, dishwasher-safe, antistatic, deburred edges, rounded corners

item	version	l x w in cm
8006.08	rectangular	80x21
8006.14	rectangular	91x21
8006.15	rectangular	102x21



coup plate "Catering"

china, white, round, flat

item	Ø in cm	PU
3954.21	21	12 pcs

etagere "Falcon"

massive stainless steel 18/10, highly polished, dishwasher-safe, food-safe, anti-slip silicone sleeves for use with buffet platters included

item	l x w x h in cm
8086	24x20x45



Really detached!

This etagere, inspired by the elegance of a falcon, is giving wings to the creativity at the buffet and on the table. A single one can bear up to three plates on its wings or, when used as a duo, also fitting buffet platters or a combination of both can be installed. Anti-slip supports can be plugged on if needed and thus provide a safe positioning of the platters. As a high-tea stand, the etagere carries plain white coup plates, which fit exactly into the slots of the wings.

The mirror polished, solid stainless steel (3 mm) punctuates the precious impression of the dynamic shape, incorporated handrails facilitate the service.



→ Stainless steel etageres | p. 275



test tube
test tube with flanged rim and round bottom, for holder for test tube item 4680.S and cork item 1501

item	Ø / height in cm	content in l	PU
4032.G	2/15	0.04	24 pcs



toast rack
massive stainless steel 18/10, hammered, polished, for 4 slices of toast

item	l x w x h in cm
2190	20x8.5x15



tray
stainless steel 18/10, polished, for e.g. Darbo portion jam (28 g and 40 g), portion ketchup or mustard

item	version	l x w in cm
2191.03	3 holes (Ø 4.5 cm)	19.5x7.5
2191.04	4 holes (Ø 4.5 cm)	24x7.5



Also suitable for tealights

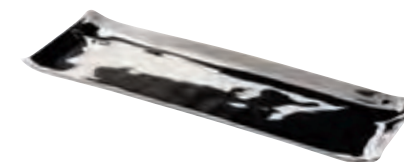

pastry tray
massive stainless steel 18/10, rectangular, hammered, polished

item	l x w in cm
2136	30x12.5



tray
stainless steel 18/10, satiné, also suitable for Darbo portion jam, for inserts up to 4 cm x 4 cm

item	l x w x h in cm
2057	18.3x4.8x2



glass tray
clear glass, 4 deepenings (Ø 4.6 cm), for inserts and portion jam up to Ø 4.4 cm (e.g. Darbo portion jam, 28 g and 40 g)

item	l x w x h in cm	PU
5428.04	23.5x6.2x3	6 pcs



food display
massive stainless steel 18/10, hammered, polished

item	version	l x w x h in cm
2194.03	3 holes (Ø 2.0 cm)	20x5.5x7.5
2194.06	6 holes (Ø 2.0 cm)	21x9.5x11.5

glass cone
clear glass, for food display items 2194...

item	Ø / height in cm	content in l	PU
5415	3.5/8	0.03	12 pcs

holder for test tubes
silicone, Ø 4.6 cm, 2.7 cm high, with grooves on the inside for easy insertion of glass tubes, for test tube item 4032.G

item	colour	PU
4680.S	black	6 pcs

cork
for test tube item 4032.G

item	Ø in cm	length in cm	PU
1501	2/1.7	2.6	24 pcs



3468.02 + 5317



3468.02 + 4498



3468.02 + 4954.02



3466.02 + 5405



small bowl "Catering"
china, white

item	Ø / height in cm	content in l	PU
4499	8/5.5	0.2	6 pcs



cruet stand
stainless steel 18/10, polished, heavy quality, for inserts with a maximum Ø of 8.2 cm

item	version	l x w x h in cm
3468.02	hammered	18.5x8.7x22



cruet stand
stainless steel 18/10, polished, heavy quality, for inserts with a maximum Ø of 5.1 cm

item	version	l x w x h in cm
3466.02	hammered	16x11.5x21



vinegar/oil bottle
clear glass, with glass stopper

item	Ø / height in cm	content in l	PU
5317	8/15.5	0.23	2 pcs



small bowl
china, white

item	Ø / height in cm	content in l	PU
4498	8/6	0.17	6 pcs



small glass bowl "Halfmoon"
borosilicate glass, transparent, handblown, double-walled

item	Ø / height in cm	content in l	PU
4954.02	8/9	approx. 0.17	6 pcs



miniature
china, white, stackable

item	Ø / height in cm	content in l	PU
4490	5.1/7	0.1	6 pcs



glass miniature
clear glass

item	Ø / height in cm	content in l	PU
5405	5/8.6	0.1	6 pcs



glass miniature
borosilicate glass, transparent, handblown, double-walled, with reinforced rim

item	Ø / height in cm	content in l	PU
4901.03	6/7.5	approx. 0.08	6 pcs



dash bottle "Eddy - Dash!" with drop pourer
borosilicate glass, transparent, handblown, incl. drop pourer item 1504

item	Ø in cm	height in cm	content in l
4893	9	14	0.35



glass tray
glass, deep black, with 3 round sockets (bottom area: Ø 6 cm)

item	l x w in cm
5145	32x12



drop pourer
cork with plastic, for pouring tiny portions of liquid, suitable for dash bottle item 4893

item	Ø in cm	height in cm
1504	2.4	5.4



small glass bowl "Halfmoon"
borosilicate glass, transparent, handblown, double-walled

item	Ø / height in cm	content in l	PU
4954.02	8/9	approx. 0.17	6 pcs



small bowl "Catering"
china, white

item	Ø / height in cm	content in l	PU
4499	8/5.5	0.2	6 pcs



miniature glass bottle
clear glass, round, with glass lid (round), with notched stopper for pouring with closed lid, height incl. lid

item	Ø in cm	height in cm	content in l
5741	4.3	5.5	approx. 0.03



glass bottle/creamer
clear glass, square, with glass stopper (round), with notched stopper for pouring with closed lid, height incl. stopper

item	l x w x h in cm	content in l	PU
5740	5x5x12.5	0.12	3 pcs



freeflow pourer with flap
18/10 stainless steel, mirror polished finish, with natural cork and breather tube for smooth flow, suitable for dash bottle item 4893

item	Ø in cm	height in cm
1505	2.4	9



glass tumbler
borosilicate glass, transparent, handblown, double-walled

item	Ø / height in cm	content in l	PU
4907	8/10	approx. 0.28	6 pcs



small bowl
china, white

item	Ø / height in cm	content in l	PU
4498	8/6	0.17	6 pcs



"Ménage-à-trois"
stainless steel 18/10, for 3 bowls (Ø inside: 8.4 cm each)

item	Ø in cm	height in cm
2058	16.5	18

Cruet stands and trays ...

... made of stainless steel ...

... or wooden bread boxes ...



Please note:
The numeration 1-25 refers to the items on pages 286-289.

2 cruet stand for inserts up to 5 cm x 5 cm
stainless steel 18/10, satined

item	l x w x h in cm
2056	11.4x11.4x16



3 cruet stand for inserts up to 7 cm x 7 cm
stainless steel 18/10, satined

item	l x w x h in cm
2056.01	15.4x15.4x22.5

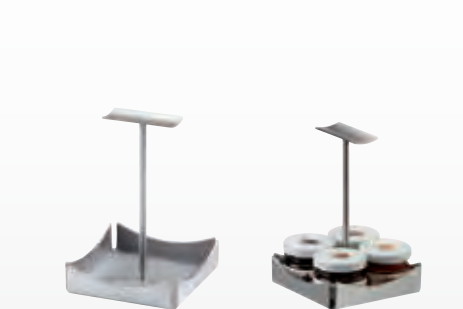

1 cruet stand for inserts up to 4 cm x 4 cm
stainless steel 18/10, satined, also suitable for Darbo-portion jam

item	l x w x h in cm
2056.02	9.4x9.4x13.6



3 cruet stand for inserts up to 7 cm x 7 cm
stainless steel 18/10, satined

item	l x w x h in cm
2056.01	15.4x15.4x22.5



4 tray for inserts up to 4 cm x 4 cm
stainless steel 18/10, satined, also suitable for Darbo portion jam

item	l x w x h in cm
2057	18.3x4.8x2

Cruet stands and trays in many different sizes and variations as well as a number of suitable inserts are summarised on pages 288 to 289. The inserts and the compartments of the trays come in three different sizes (4 cm x 4 cm, 5 cm x 5 cm and 7 cm x 7 cm) and will therefore fit for every occasion.



6 tray "Solid" for inserts up to 5 x 5 cm
walnut, food-safe sealed, not dishwasher-safe, with 4 rubber feet

item	l x w x h in cm
4703	24.4x12.4x4

7 glass insert/coaster
clear glass, with 4 transparent rubber feet, for tray "Solid" item 4708

item	l x w x h in cm	PU
4708.G	20.7x5.1x0.4	2 pcs



5 box "Solid" for inserts up to 5 x 5 cm
walnut, food-safe sealed, not dishwasher-safe, with 4 rubber feet, 2 compartments: 10.4 cm x 5.2 cm and 10.4 cm x 16.6 cm

item	l x w x h in cm
4703	24.4x12.4x4



6 tray "Solid" for inserts up to 5 x 5 cm
walnut, food-safe sealed, not dishwasher-safe, with 4 rubber feet

item	l x w x h in cm
4719	15.2x15.2x2.5



8 tray "Solid" for inserts up to 5 x 5 cm
walnut, food-safe sealed, not dishwasher-safe, with 4 rubber feet

item	l x w x h in cm	l x w (inside) in cm
4708	25.8x10.2x2	20.8x5.2

... with suitable inserts made of glass and china ...

... for every purpose!

Inserts up to 4x4 cm



9 glass bottle
clear glass, square, suitable cork item 5297.01 (please order separately)

item	l x w x h in cm	content in l	PU
5296.01	3.9x3.9x8.5	0.04	12 pcs



10 cork
plastic, ecru, for glass bottle item 5296.01

item	Ø in cm	height in cm	PU
5297.01	2	2.2	24 pcs

Inserts up to 5x5 cm



12 glass bottle
clear glass, square, suitable cork items 5297.02 (please order separately)

item	l x w x h in cm	content in l	PU
5296.02	4.9x4.9x11	0.1	12 pcs



13 cork
plastic, ecru, for glass bottle item 5296.02

item	Ø in cm	height in cm	PU
5297.02	2.6	2.8	24 pcs



2+14+20

Inserts up to 7x7 cm

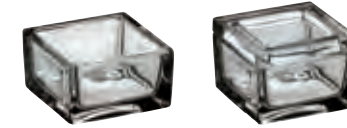

21 small bowl
clear glass, square, delivery without lid item 5338.01 (please order separately)

item	l x w x h in cm	content in l	PU
5338	7x7x3.9	0.1	12 pcs



22 glass miniature
clear glass, square, lid for small glass bowl item 5338

item	l x w in cm	PU
5338.01	7x7	12 pcs



1+11



11 salt & pepper mill set
acrylic glass, square, with ceramic grinder, without filling, 5-years guarantee

item	l x w x h in cm	PU
2779	3.7x3.7x9	1 set (2 parts)



14 glass bottle
clear glass, square, with swing top (plastic and stainless steel), height incl. swing top, **only for cruet stand item 2056!**

item	l x w x h in cm	content in l	PU
5295.01	5.4x5.4x12.5	0.1	12 pcs



15 glass bottle/creamer
clear glass, square, with glass stopper (round), with notched stopper for pouring with closed lid, height incl. stopper

item	l x w x h in cm	content in l	PU
5740	5x5x12.5	0.12	3 pcs

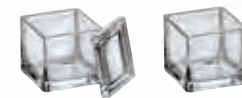

16 small glass bowl
clear glass, square, delivery without lid item 5254.01 (please order separately)

item	l x w x h in cm	content in l	PU
5254	4.9x4.9x4.5	0.05	4 pcs



19 small bowl
china, black, matt

item	l x w x h in cm	content in l	PU
3855.01	4.9x4.9x7	0.11	4 pcs



17 small glass creamer
clear glass, square, delivery without lid item 5254.01 (please order separately)

item	l x w x h in cm	content in l	PU
5255	4.9x4.9x4.5	0.05	4 pcs



20 small bowl
china, square, 4.9 cm long, 4.9 cm wide, 4.5 cm high, 0.05 l content

item	colour	PU
3845	white	4 pcs
3845.01	black matt	4 pcs



23 glass bottle
clear glass, square, with swing top (plastic and stainless steel), height incl. swing top

item	l x w x h in cm	content in l	PU
5295.02	6.7x6.7x14.5	0.2	12 pcs



24 small bowl
china, white, square

item	l x w x h in cm	content in l	PU
3854	7x7x4.5	0.13	4 pcs



25 small bowl
china, white, square

item	l x w x h in cm	content in l	PU
3853	7x7x2	0.05	12 pcs



4+11+24

1+9+10

Please note:

The numeration 1–25 refers to the items on pages 286–289.



→ More items made of melamine and numerous variations | p. 138-146

Please note:
 Items made of melamine are not to be used for cooking in microwave and combi steam oven!
 Cleaning in the dishwasher is possible up to a maximum water temperature of 70 degrees.



→ More trays and boxes made of melamine | p. 140-145

... for item 4590

... for item 4593



spoon rest "Modul"
 melamine, black, surface matt, food-safe, not suitable for microwave and combi steam oven, with 4 rubber feet (black)

item	l x w x h in cm	PU
4585	20x5x4	2 pcs



tray
 melamine, black, surface matt, food-safe, not suitable for microwave and combi steam oven

item	l x w x h in cm	PU
4586	25.2x13.2x1.8	2 pcs

2/8 GN tray
 melamine, black, surface matt, food-safe, not suitable for microwave and combi steam oven, with 3 oval sockets (diagonal), for small bowls items 4081.12 (china) and 5444 (glass)

item	l x w x h in cm	PU
4593	32.5x13.2x1.8	2 pcs



Suitable for items with bottom diameter smaller than 5.5 cm or 8.2 cm

2/8 GN tray
 melamine, black, surface matt, food-safe, not suitable for microwave and combi steam oven, with 3 round sockets (Ø 5.5 cm / 8.2 cm)

item	l x w x h in cm	PU
4590	32.5x13.2x1.8	2 pcs



glass bottle
 clear glass, with swing top (PVC lid), height incl. swing top

item	Ø / height in cm	content in l	PU
5290.02	5.5/19	0.2	12 pcs



glass
 clear glass

item	Ø / height in cm	content in l	PU
5380	7.5/10.5	0.32	6 pcs



miniature
 china, white, stackable

item	Ø / height in cm	content in l	PU
4490	5.1/7	0.1	6 pcs



small bowl "Catering"
 china, white

item	Ø / height in cm	content in l	PU
4499	8/5.5	0.2	6 pcs

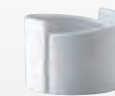

small bowl
 china, white

item	Ø / height in cm	content in l	PU
4498	8/6	0.17	6 pcs



glass miniature
 borosilicate glass, transparent, handblown, double-walled

item	Ø / height in cm	content in l	PU
4903	5.5/8.5	approx. 0.1	6 pcs



small glass bowl "Halfmoon"
 borosilicate glass, transparent, handblown, double-walled

item	Ø / height in cm	content in l	PU
4954.02	8/9	approx. 0.17	6 pcs



glass tumbler
 borosilicate glass, transparent, handblown, double-walled

item	Ø / height in cm	content in l	PU
4907	8/10	approx. 0.28	6 pcs



glass bowl
 clear glass, oval

item	l x w x h in cm	content in l	PU
5444	12.5x7x4	0.08	6 pcs



bowl
 china, white, oval

item	l x w x h in cm	content in l	PU
4081.12	12.5x7x5x4	0.1	12 pcs

Glass trays with suitable inserts



glass tray

glass, deep black, with 3 round sockets (bottom area: Ø 6 cm)

item	l x w in cm
5145	32x12



small glass bowl "Halfmoon"

borosilicate glass, transparent, hand-blown, double-walled

item	Ø / height in cm	content in l	PU
4954.01	6/7.5	approx. 0.08	6 pcs



cocktail glass "The Pill"

borosilicate glass, upper part transparent, lower part satined, handblown

item	Ø / height in cm	content in l	PU
4970	8/14	0.47	6 pcs



glass bowl

borosilicate glass, transparent, handblown, double-walled

item	Ø / height in cm	content in l	PU
4956.01	9/4	0.07	6 pcs



cocktail glass "The Viking III"

borosilicate glass, transparent, handblown, 3 satined feet

item	Ø / height in cm	content in l	PU
4976	8.5/12	0.43	6 pcs



dash bottle "Eddy - Dash!" with drop pourer

borosilicate glass, transparent, handblown, incl. drop pourer item 1504

item	Ø in cm	height in cm	content in l
4893	9	14	0.35



drop pourer

cork with plastic, for pouring tiny portions of liquid, suitable for dash bottle item 4893

item	Ø in cm	height in cm
1504	2.4	5.4



freeflow pourer with flap

18/10 stainless steel, mirror polished finish, with natural cork and breather tube for smooth flow, suitable for dash bottle item 4893

item	Ø in cm	height in cm
1505	2.4	9



glass

clear glass

item	Ø / height in cm	content in l	PU
5380	7.5/10.5	0.32	6 pcs

Candle holders
Wind lights



"Reef"



Please note:
For tealights or candles up to a height of 10 cm and a diameter of 7 cm.



The wind light fascinates with the reflections of light and the dancing shadows. A removable cylinder made of heat resistant glass protects the flame from wind and thus allows the usage in the garden and on the terrace.

Since medieval times, pewter has been used for table top items and has been the most important raw material for a very long time. The popularity of pewter first started decreasing in the 18th and 19th century by the progressing development of glass and the increasing popularity of porcelain. Since then, the usage of pewter has focused mainly to decorative elements. Up-to-date pewter is 100 % lead-free and therefore uncritical when used for food.



candle holder/wind light "Reef"

pewter, surface smooth, food-safe, not dishwasher-safe, with feet, for glass insert item 4991.02 and candles up to Ø 7 cm

item	Ø in cm	height in cm
2315.01	10	15,5

wind light

borosilicate glass, satined inside, open at the top and at the bottom, for candle holder/wind light "Reef" item 2315.01

item	Ø in cm	height in cm	PU
4991.02	9	14,5	6 pcs

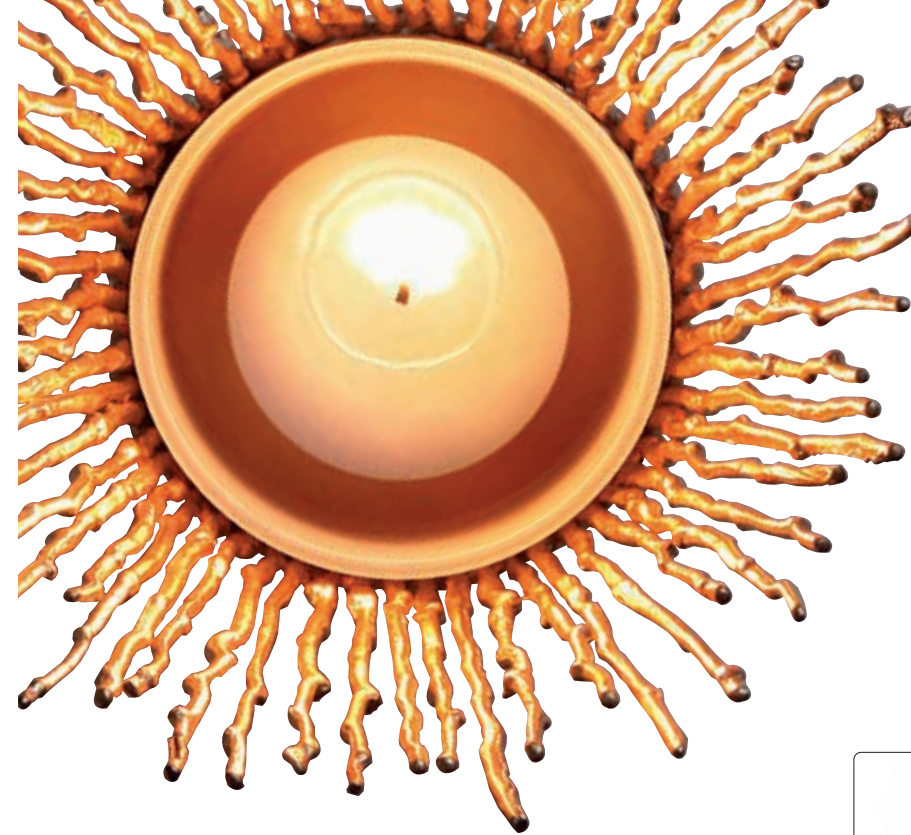

"Somnia"

With candlelight, this extraordinary lighting object creates fascinating effects and provides for a cosy and comfortable ambience.

The filigree rods are made of brass and manufactured piece by piece in traditional sand casting. Afterwards they are soldered onto a solid baseplate with an elevated rim. This baseplate avoids the leakage of wax and protects the table surface from the heat.

Additionally, it forms the frame for a removable cylinder made of heat resistant glass, which by way of its satined surface, intensifies the mood of the light and protects the flame from wind at the same time.

Please note:
For tealights or candles up to a height of 10 cm and a diameter of 7 cm.

candle holder/wind light "Somnia"

brass, golden, matt, not dishwasher-safe, for glass insert item 4991.02 (please order separately) and candles up to Ø 7 cm

item	Ø stand in cm	Ø top in cm	height in cm
2383.01	11	approx. 16,5	approx. 19,5

wind light

borosilicate glass, satined inside, open at the top and at the bottom, for candle holder/wind light "Somnia" item 2383.01

item	Ø in cm	height in cm	PU
4991.02	9	14,5	6 pcs

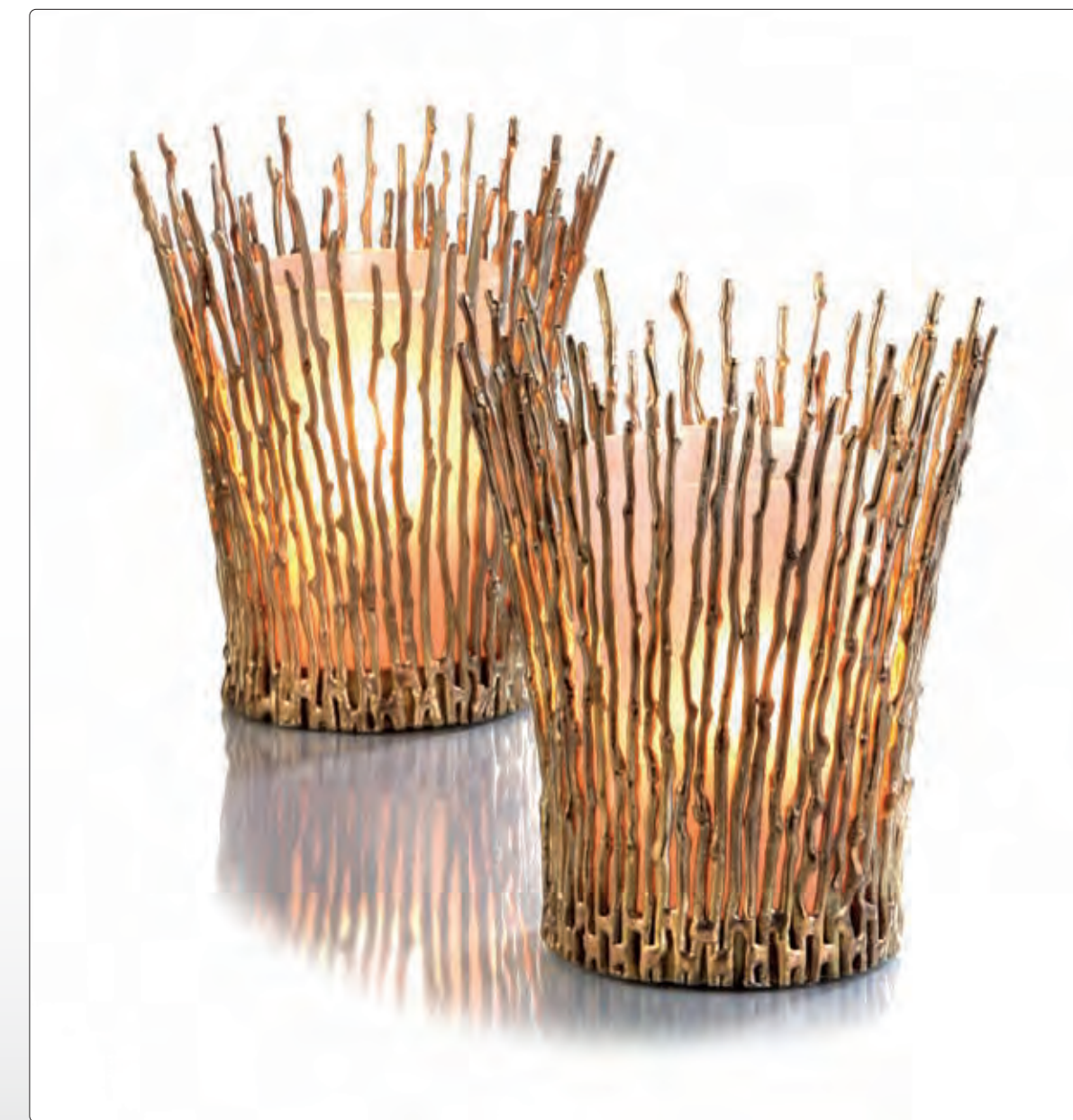



insert for cigars

solid surface material, black, for 4 cigars (grooves 1.9 cm wide), storage area for accessories (14.8 cm x 4.8 cm), for storage/presentation box "Solid" item 4762.18

item	l x w x h in cm
4763.02S	15.8x15.8x1



Improved recessed grip

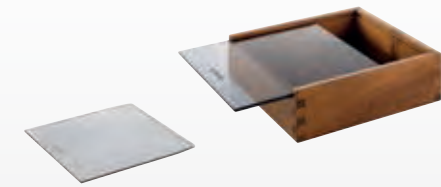

glass lid

hardened glass, grey tinted, with recess, for storage/presentation box "Solid" item 4762.18

item	l x w in cm
4762.18G	17.3x16.7

storage/presentation box "Solid"

walnut, food-safe sealed, not dishwasher-safe, with sliding lid made of wood, also useable with glass lid item 4762.18G (please order separately)

item	l x w x h in cm	size inside in cm
4762.18	18x18x6	approx. 16x16x4.2



wind light

borosilicate glass, satined inside, open at the top and at the bottom, for tealight holder "Solid" item 4700.01

item	Ø in cm	height in cm	PU
4991.02	9	14.5	6 pcs



ashtray for cigars

optical glass, transparent, also useable as a rest for tongs or spoons, in black gift box

item	l x w x h in cm
5210	15x9x3



coaster "Solid"

walnut, food-safe sealed, not dishwasher-safe

item	Ø / height in cm	Ø inner circle in cm
4700.01	15.3/2	9.3



Room service
Guest room



"Solid"

This service tray with integrated separations is perfectly suitable for the service of small dishes at the pool, the beach or in the room. The major compartment has been designed for plates with a max. diameter of up to 29 cm, the lateral separation offers sufficient space for cutlery and napkin. Also insertion bowls with a max. width of 7.5 cm will find space and thus can be used for dips, salad and other side dishes. You will find a selection of suitable inserts on page 289.

The trays are equipped with integrated grip holes and are stackable. Finger joints at the corners, non-skid rubber feet and a food-safe sealing of the solid walnut wood fulfill the high-quality standards, which are valid for all items of the "Solid" range.



stackable



serving tray "Solid"

walnut, food-safe sealed, not dishwasher-safe, stackable, 2 compartments: 30 cm x 30 cm and 30 cm x 8 cm (for cutlery or china/glass bowls), with 4 rubber feet

item	l x w x h in cm
4769	41.7x32.5x6.7

Please note:



The trays 4707 and 4769 are not suitable for the tray stand item 4748 (p. 299).



4707 + 1668.03



glass platter

special hardened safety glass, 4 mm thick, rectangular, rounded edges, polished rim, dishwasher-safe, rubber feet included (adhesive), underside scratch-proof, for serving tray "Solid" items 4707 and 4740

item	version	l x w in cm
1668.03	black glass	50x34



serving tray "Solid"

walnut, flat, food-safe sealed, not dishwasher-safe, with 2 recessed grips, with 4 rubber feet

item	l x w x h in cm	l x w (inside) in cm
4707	53x37x4	50.2x34.2



4748+4735

The room service tray (4735) as well as the "Solid" bed tray (4773) stand out due to the recessed longside, which enables comfortable dining directly off the tray. The retractable feet of the bed tray have been constructed in a very stable way and are securely kept in position by integrated magnets when folded in. The height of the erected tray has been chosen in a way that, even with soft mattresses, a comfortable seating beneath the tray is guaranteed.

The tray stand always provides the appropriate possibility to set up the "Solid" room service tray (4735) in the hotel room, but also in the restaurant. Rubber feet on the top prevent the shifting of platters and trays, felt gliders at the base protect the parquet flooring and ensure safe standing.

All information can be found on page 137.



tray stand/side table "Solid"

walnut, with black nylon ribbons, anti-slip rubber feet on top and felt gliders at the bottom, for trays and buffet platters in sizes starting from 55 cm x 36 cm, 102 cm high (folded up), 87 cm high (opened)

item	l x w x h in cm (opened)
4748	54.5x36x87



The rubber feet at the base are set back from the rim to enable the transport on a tray trolley in 1/1 EN-format (60 cm x 40 cm).



room service tray "Solid"

walnut, food-safe sealed, not dishwasher-safe, stackable, recessed on one side of the rim, with 2 handles, with 4 rubber feet, suitable for tray stand "Solid" item 4748

item	l x w x h in cm
4735	60x40x5.4



Breakfast in bed – Inroom dining!



bed tray "Solid"

walnut, food-safe sealed, not dishwasher-safe, stackable, with feet, 2 handles, recessed on one side of the rim

item	l x w x h in cm (closed)	l x w x h in cm (set up)
4773	60x40x6.5	approx. 74x40x31





cutlery/napkin box “Solid”

walnut, food-safe sealed, not dishwasher-safe, with rubber feet in the lid (soft closure, can be opened to an angle of 90° only), with black felt insert, stainless steel platter with space for an engraving (price and quantity upon request), height with open lid: 15.5 cm

item	l x w x h in cm	size inside in cm
4766	28.8x11.8x6	26x8.7



serving tray “Solid”

walnut, food-safe sealed, not dishwasher-safe, with 4 rubber feet

item	l x w x h in cm	l x w in cm (inside)
4713	34x34x3	32x32

Improved recessed grip



1 storage/presentation box “Solid”

walnut, food-safe sealed, not dishwasher-safe, with sliding lid made of wood, also useable with glass lid item 4762.18G (please order separately)

item	l x w x h in cm	size inside in cm
4762.18	18x18x6	approx. 16x16x4.2

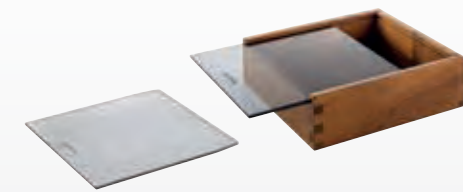

2 glass lid

hardened glass, grey tinted, with recess, for storage/presentation box “Solid” item 4762.18

item	l x w in cm
4762.18G	17.3x16.7

Delicacies in delicate setting!

Due to the comprehensive range of accessories, the “Solid” presentation box offers multiple application possibilities. The box, regularly fitted with a wooden sliding lid, can be equipped with several optionally available inserts made of top-quality solid surface material. The also available lid made of brown-tinted glass puts the presented goods in the limelight.

Apart from an insert with round cavities for nine truffles/chocolates and a flat plate which can be used for layered chocolates, various little somethings or amuse bouches, there is also an insert available for commercial coffee capsules. The insert for cigars can hold up to four cigars and a separate compartment aside offers additional space for matches, cigar cutters, etc.

The glass lid made of grey-tinted glass, which is also available, impressively sets the scene for what is being presented.



Please note:

Wooden items are not dishwasher-safe, do not immerse in water!



1+2+3

1+2+5



1+2



1+2+4



1+2+5



1+2+6



3 insert for chocolates

solid surface material, with 9 cavities (Ø 2.2 cm), for storage/presentation box “Solid” item 4762.18

item	colour	l x w x h in cm
4763.01S	black	15.8x15.8x1
4763.01W	white	15.8x15.8x1

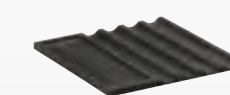

4 insert for cigars

solid surface material, black, for 4 cigars (grooves 1.9 cm wide), storage area for accessories (14.8 cm x 4.8 cm), for storage/presentation box “Solid” item 4762.18

item	l x w x h in cm
4763.02S	15.8x15.8x1



5 insert for coffee capsules

solid surface material, black, with 6 cavities (Ø 3.8 cm), storage area for accessories (14.8 cm x 4.8 cm), for storage/presentation box “Solid” item 4762.18

item	l x w x h in cm
4763.03S	15.8x15.8x1



6 insert/platter

solid surface material, white, usable area: 14.8 cm x 14.8 cm, for storage/presentation box “Solid” item 4762.18

item	l x w x h in cm
4763.04W	15.8x15.8x1



Hotel cosmetic: PAM Berlin Slipper & Hotel Supplies – www.pam-berlin.de

"DryPod"



Primarily, "DryPod" is a dry rack for decanters. The solid structure made of brushed stainless steel, refined in either black or brass colour, forms the basis for this shapely product. Also besides its actual determination, "DryPod" is tempting by its versatility. As an etagere on the laid table or in the hotel room, the rack can be equipped with numerous other Zieher articles and thus presents food and delicacies in an impressive way. Please find all information about "DryPod" on page 222/223.



decanter dry rack/display "DryPod"
massive stainless steel 18/10, brushed, pvd-coated, with 3 anti-slip rubber feet (not dishwasher-safe), suitable for all Zieher decanters

item	Ø in cm	height in cm	colour
2230	18	26	brass
2232	18	26	black

dry rack/display "DryPod" with drip tray

set consists of:
dry rack/display stainless steel 18/10, brushed, pvd-coated
drip tray made of resin, anthracite, matt, translucent
1 set in black gift box

item	Ø in cm	height in cm	colour
2231.PB	18	26	brass
2233.PB	18	26	black



drip tray
resin, anthracite, matt, translucent, not dishwasher-safe, suitable for decanter dry rack "DryPod" items 2230 and 2232

item	Ø in cm	height in cm
7030	12.5	1

→ "Sombre" | p. 156



→ Glass cloche 4982 + 4982.09 | p. 192
→ Miniature plate 4607.10 + 4607.17 | p. 247



→ Glass bowl 4814.17 | p. 232
→ Cloche 4940.08 | p. 190



→ "DressCoat" 4388 | p. 182



→ Miniature plate 4607.17 | p. 247
→ Cloche 4940.08 | p. 190

"Fleur Déco" NEW

A Tribute to the Beauty of Nature

"Fleur Déco" is entirely made of brass and includes a three-tiered etagere for plates and platters, a serving platter and a buffet tree with a floral design.

Each component of these unique pieces is cast from brass and meticulously finished to achieve the perfect balance between golden and dark patinated areas. Each blossom, each branch is carefully assembled with loving craftsmanship to create a harmonious and floral appearance that seamlessly blends natural beauty with functionality.

You can find all the information about the series on pages 96 to 99.



serving tray/platter "Fleur Déco"
brass, golden/antique (transparent coating, food-safe), Ø bottom plate 22 cm, not dishwasher-safe

item	Ø in cm	height in cm
2389	22	approx. 24



etagere "Fleur Déco"
brass, golden/antique (transparent coating, food-safe), Ø bottom plate 22 cm, with 10 miniature plates (approx. 13 cm x 8 cm), not dishwasher-safe

item	Ø in cm	height in cm
2388.10	40	approx. 47.5



etagere "Fleur Déco"
brass, golden/antique (transparent coating, food-safe), with 3 levels (Ø inside: 23 cm), not dishwasher-safe

item	Ø in cm	height in cm
2387	36	approx. 55



Please note:

All items in the "Fleur Déco" series are food-safe, allowing for the direct placement of cold and dry foods on the étagères. For other purposes Zieher offers a wide selection of bowls as well as matching plates and dishes. Do not clean in the dishwasher.



The etagere with three tiers, made of hammered and highly polished stainless steel, forms an extravagant basis for many sorts of plates and platters. Even in the hotel room, the etageres can be positioned in an eye-catching way. Equipped with "DressCoat" or other tableware, small snacks, a selection of fruit or a sweet welcoming treat can be staged in an appealing way. All information about this etagere are available on page 94.

 We recommend the use of large plates on the lower level only.



etagere "DressCoat"
massive stainless steel 18/10, hammered, polished, 3-armed

item	Ø in cm	height in cm
2212.30	36	30



plateau plate "DressCoat"
white china, useable area (plateau): Ø 19.5 cm, also useable as a bowl

item	Ø / height in cm	content in l	PU
4388	22/6.5	0.9	3 pcs



glass plate "Unique"
glass, white marbled, bottom satined, round

item	Ø in cm	PU
5178.21	21	6 pcs
5178.28	28	6 pcs



porcelain pillow "Donna"
white, not dishwasher-safe

item	l x w x h in cm
4461.02	33x22x7



glass pillow "Donna"
glass, satined, in black gift box

item	l x w x h in cm
5446.01PB	16.5x11x3

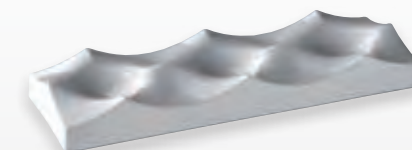

platter "Collina"
china, white, not dishwasher-safe, with 3 deepenings, with 4 rubber feet (enclosed in the pack)

item	l x w x h in cm
4504	36.5x12.5x4.5

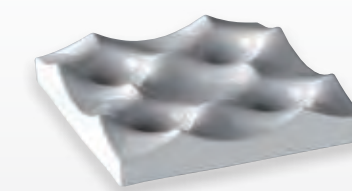

platter "Collina"
china, white, not dishwasher-safe, with 4 deepenings, with 4 rubber feet (enclosed in the pack)

item	l x w x h in cm
4503	24.5x24.5x4.5



Extraordinary storage places for extravagant guestrooms

The organic forms of these extraordinary objects offer an ideal presentation area for high-end dishes or to keep various items of everyday life.



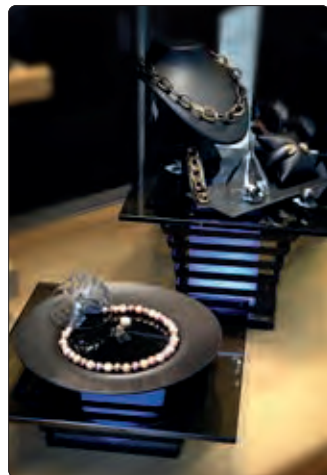

Discover our exclusive product variety in the current Zieher catalogues

Our catalogues are available as download and interactive online version with the option to start an inquiry with just a few clicks or partially printed issue. It's your choice!



The buffet systems by Zieher were developed to put the most exquisite products into the limelight in a very effective and diversified way.

The section "displays" shows that they are not limited to the use with food.

High-class jewellery and watches, as well as other kinds of luxury goods find a representative stage with the Zieher display systems.

The discreet and classy design does not push for attention, but offers a unique and distinctive means of presentation that puts the product at the centre of attention.

Contact: display@zieher.com



Photo: www.juwelier-hohenberger.de



Catalogue download (PDF)
ZIEHER Professional 2024



All catalogues:
An overview of all current catalogues, sales brochures and the option to download PDF files can be found here.
You can also use the interactive online catalogues directly if you wish



Catalogue download (PDF)
FOR WINE LOVERS 2024

WWW.ZIEHER.COM

quick-finder – list of ascending order

item	description	page
1501	cork	154, 238, 280
1504	drop pourer	230, 284, 292
1505	freeflow pourer with flap	230, 284, 292
1668.01	buffet platter, black glass	60
1668.03	buffet platter, black glass	60, 130, 257, 298
1668.04	buffet platter, black glass	60
1668.05	buffet platter, black glass	60
1668.06	buffet platter, black glass	60, 189
1668.08	buffet platter, black glass	60, 113, 114, 117, 278
1668.15	buffet platter Curve 90°	60
1668.20	buffet platter, black glass	60, 122
1668.22	buffet platter, black glass	60, 114, 278
1668.24	buffet platter, black glass	60, 114, 278
1669.33	charger plate, black glass	16, 18, 60, 189, 195
1670.01	buffet platter, white glass	61
1670.04	buffet platter, white glass	61
1670.09	buffet platter, white glass	61
1670.10	buffet platter, white glass	61, 177, 189
1670.12	buffet platter, white glass	61, 116
1670.14	buffet platter Curve 45°	61
1670.15	buffet platter Curve 90°	61
1670.20	buffet platter, white glass	61, 122
1671.33	charger plate	16, 18, 61, 78, 189, 195
1671.53	buffet platter, white glass	61
1938.01	party spoon	152, 248
1939.01	skewer	104, 153, 248, 250
2056	cruet stand for inserts up to 5 cm x 5 cm	286
2056.01	cruet stand for inserts up to 7 cm x 7 cm	286
2056.02	cruet stand for inserts up to 4 cm x 4 cm	286
2057	tray	281, 286
2058	"Ménage-à-trois"	285
2101.17	tray	119, 275
2105.03	etagere	119, 275
2107.03	etagere	118, 274
2109	bowl "Loop"	81
2110	etagere	118, 274
2110.01	tray	118, 274
2115	tongs holder	121
2119	buffet etagere	116
2119.01	tray	116
2120.15	bowl "Medusa"	79
2120.25	bowl "Medusa"	79
2120.38	bowl "Medusa"	79
2136	pastry tray	120, 281
2138	chocolate/ice cube tongs	121, 264
2139	serving tongs	121
2140	serving tongs	121
2141.01	buffet stand	82
2141.02	buffet stand	82
2141.03	buffet stand	82
2154	spoon rest	121
2167.15	holder coil shape	104, 250
2167.20	holder coil shape	104, 250
2167.25	holder coil shape	104, 250
2167.30	holder coil shape	104, 250



2169	bowl "Wings"	80
2171	bowl "Sixth Sense"	81
2171.01	bowl "Sixth Sense"	81
2171.02	bowl "Sixth Sense"	81
2174	bowl	82
2177.10	buffet stand "Skyline"	34
2177.22	buffet stand "Skyline"	34
2177.34	buffet stand "Skyline"	34
2177.58	buffet stand "Skyline"	34
2178.23	fruit/bread basket "Skyline"	35
2179.10	fruit/bread basket "Skyline"	35
2179.34	fruit/bread basket "Skyline"	35
2180.09	bowl	83, 248
2180.13	bowl	83, 248
2180.22	bowl	83
2180.30	bowl	83
2180.40	bowl	83
2181.17	bowl	82
2181.21	bowl	82
2181.24	bowl	82
2182.09	bowl	83, 249
2182.13	bowl	83, 249
2182.22	bowl	83
2182.30	bowl	83
2182.30	bowl	83
2183	bowl	82
2187	etagere	83, 249, 276
2189	etagere/pastry stand	276
2190	toast rack	120, 281
2191.03	tray	248, 281
2191.04	tray	248, 281
2193	buffet etagere	117
2193.01	tray	112, 117
2194.03	food display	280
2194.06	food display	280
2201	etagere with 3 tiers (each 7 miniature plates)	103, 272
2202	etagere with 1 tier (7 miniature plates)	103, 272
2203.08	miniature plate with rod	104, 250
2203.13	miniature plate with rod	104, 250
2203.18	miniature plate with rod	104, 250
2203.23	miniature plate with rod	104, 250
2204.08	amuse gueule stand with foot	103, 249, 272
2204.11	amuse gueule stand with foot	103, 249, 272
2206.50	bowl flat	80
2206.60	bowl flat	80
2207.11	ice cream cup with foot	103, 249, 272
2207.15	ice cream cup with foot	103, 249, 272
2208.06	etagere "Table-Tree" Flower	102, 270
2208.13	etagere "Flower-Tree"	101, 271
2208.25	etagere "Flower-Tree"	101, 271
2209.13	etagere "Flex-Tree"	100, 271
2209.25	etagere "Flex-Tree"	100, 271
2210.06	etagere "Table-Tree" Pin	102, 270
2212.30	etagere "DressCoat"	94, 277, 304
2220.70	wine cooler stand "Mikado"	108, 225
2230	decanter dry rack/display "DryPod"	223, 273, 302
2231.PB	decanter dry rack/display "DryPod" with drip tray	223, 302



2232	decanter dry rack/display "DryPod"	223, 273, 302
2233.PB	decanter dry rack/display "DryPod" with drip tray	223, 302
2260.16	bowl "Shine"	86, 132
2260.20	bowl "Shine"	86
2260.24	bowl "Shine"	86
2310	bowl/basket "Reef"	72, 234
2311	bowl/basket "Reef"	72
2313.01	bowl/basket "Reef"	71
2313.02	bowl/basket "Reef"	71
2314.02	bowl/basket "Reef"	71
2314.03	bowl/basket "Reef"	71
2315.01	candle holder/wind light "Reef"	71, 294
2317	napkin ring "Reef"	188
2318	small bowl/basket "Reef"	72, 232, 234
2320	bowl/basket "Reef"	72, 234
2322	bowl/basket "Reef"	72
2332	bowl/basket "Reef"	70
2335	bowl/basket "Reef"	70
2336	bowl/basket "Reef"	70
2337	bowl/basket "Reef"	70
2340.15	bowl "Splash"	74, 234
2340.22	bowl "Splash"	74
2340.28	bowl "Splash"	74
2340.38	bowl "Splash"	74
2350	bowl/basket "Leaf"	73, 234
2353.02	bowl/basket "Leaf"	73
2358	small bowl/basket "Leaf"	73, 232, 234
2370.23	tray "Artisan"	85
2370.28	tray "Artisan"	85
2370.33	tray "Artisan"	85
2371.07	bowl "Artisan"	85, 248
2371.11	bowl "Artisan"	85, 248
2371.14	bowl "Artisan"	85
2372	bread/pastry bowl "Artisan"	84
2373	bread/pastry bowl "Artisan"	84
2374.24	tray "Artisan"	85
2376	etagere "Artisan"	84
2378.30	serving tray "Orbis"	75, 267
2378.40	serving tray "Orbis"	75, 267
2380.07	bowl/display "Fakir"	76, 266
2380.12	bowl/display "Fakir"	76, 266
2380.15	bowl/display "Fakir"	76, 266
2380.18	bowl/display "Fakir"	76, 266
2381.38	bowl "Roots"	76
2382.38	bowl "Matrix"	76
2383.01	candle holder/wind light "Somnia"	28, 295
2385.01	display for bowls "Somnia"	29
2385.02	display for bowls "Somnia"	29
2386.10	buffet display "Somnia"	29
2386.20	buffet display "Somnia"	29
2387	etagere "Fleur Déco"	98, 269, 303
2388.10	etagere "Fleur Déco"	99, 269, 303
2389	serving tray/platter "Fleur Déco"	99, 269, 303
2543.30	charger plate, slate	62, 177, 189
2544.30	charger plate, slate	62, 177, 189
2550	sushi plate	177

2779	salt & pepper mill set	288
3461	card holder	120
3466.02	cruet stand	283
3468.02	cruet stand	282
3845	small bowl	154, 242, 288
3845.01	small bowl	242, 288
3853	small bowl	154, 242, 289
3854	small bowl	242, 289
3855.01	small bowl	242, 288
3954.21	coup plate "Catering"	114, 186, 278
3967.20S	plate "Sombre"	162, 268
3967.25S	plate "Sombre"	162
3967.30S	plate "Sombre"	162
3968.20S	plate "Sombre"	162
3969.15S	bowl "Sombre"	162
4032.G	test tube	154, 238, 280
4081.12	bowl	146, 246, 291
4093	small creamer	246
4260.01	amuse gueule/tapas spoon	153, 247
4281.02	bowl "Catering de Luxe"	186
4281.03	bowl "Catering de Luxe"	186
4281.04	bowl "Catering de Luxe"	186
4281.04	bowl "Catering de Luxe"	186
4375.01PB	bowl "Cave"	184, 241
4381	bowl "Modul"	152, 180, 247
4383	plate "Modul"	152, 180, 247
4385.22	plate "Modul"	152, 180
4385.27	plate "Modul"	152, 180
4386.01	plateau plate "DressCoat"	100, 182, 246
4387	plateau plate "DressCoat"	182
4388	plateau plate "DressCoat"	94, 182, 277, 304
4389.09	plateau plate/small bowl "Cuspis"	170, 190, 235
4389.11	plateau plate/small bowl "Cuspis"	170, 190, 235
4389.25PB	plateau plate/bowl "Cuspis"	170, 190
4461.02	porcelain pillow "Donna"	181, 305
4490	miniature	104, 246, 283, 291
4498	small bowl	246, 282, 285, 291
4499	small bowl "Catering"	246, 282, 285, 291
4503	platter "Collina"	179, 305
4504	platter "Collina"	179, 305
4507.01PB	plate/platter "Pulsar"	168
4507.02PB	plate/platter "Pulsar"	168
4544.20	plate "Bosque"	156, 268
4544.28	plate "Bosque"	156
4544.34	plate "Bosque"	156
4545.10	bowl "Bosque"	157
4545.16	bowl "Bosque"	157
4545.21	bowl "Bosque"	157
4545.24	bowl "Bosque"	157
4563	china ball "oro79"	187
4564.26	plate "oro79"	187
4565.35	plate "oro79"	187
4578	Bento Box	140, 254
4579	lid/tray	140, 254
4580	insert/box	140, 142, 252, 254
4581	base tray "Modul"	25, 143, 150
4582	base tray "Modul"	112, 143, 150



4583	base tray "Modul"	143, 150
4584	bridge "Modul"	146, 150
4585	spoon rest "Modul"	146, 150, 153, 290
4586	tray	143, 290
4587	GN tray	143, 290
4588	GN tray	143, 290
4589	GN tray	143, 290
4590	2/8 GN tray	146, 290
4591	cutlery/napkin box	138, 143, 153, 252
4593	2/8 GN tray	146, 290
4594	cutlery box	138, 142
4597.01	chiller base/tray	54
4597.02	chiller base/tray	54
4598.09	bowl/box	142, 252
4598.13	bowl/box	142, 252
4599.13	bowl/box	142, 252
4606.10	miniature plate	100, 247, 274
4606.17	plate	247, 275
4607.10	miniature plate	100, 247, 274
4607.17	plate	247, 275
4661.05S	coaster	100, 233, 271
4661.05W	coaster	100, 233, 271
4679.5	pedestal/ring, illuminable	91, 220
4680.S	holder for test tubes	154, 233, 238, 280
4681.S	ring "SelectionA."	91, 110, 197, 225, 232, 233
4682.S	ring "SelectionA."	91, 215, 217, 222
4685	protecting cap	29
4700	coaster "Solid"	192, 260
4700.01	saucer "Solid"	192, 260, 296
4703	box "Solid" for inserts up to 5 x 5 cm	263, 287
4707	serving tray "Solid"	130, 257, 298
4708	tray "Solid"	263, 287
4708.G	glass insert/coaster	263, 287
4713	serving tray "Solid"	136, 256, 300
4718	tray stand "Solid"	128
4719	tray "Solid" for inserts up to 5 cm x 5 cm	263, 287
4720	cutlery box "Solid"	138, 147, 262
4721	base tray "Modul"	148
4722	base tray "Modul"	112, 148
4723	base tray "Modul"	148
4724	bridge "Modul"	148
4725	spoon rest "Modul"	148
4726	card holder	120, 135, 260
4730	bridge "Solid"	132
4731	bridge "Solid"	132
4732.PB	cutting board "Solid"	132
4733	bread cutting board "Solid"	132
4733.R	replacement grate "Solid"	132
4734.01	coaster "Solid"	125, 193, 195, 261
4734.02	coaster "Solid"	125, 193, 194, 195, 261
4734.03	coaster "Solid"	125, 193, 195, 261
4734.04	coaster "Solid"	125, 193, 195, 261
4735	room service tray "Solid"	137, 255, 299
4737	chocolate/truffle box "Solid"	264



4738	chocolate/truffle box "Solid"	264
4740	serving tray "Solid"	131, 257
4741	grate insert "Solid"	131
4742	tray insert "Solid"	130
4743	tray insert "Solid"	130
4744	cutlery insert "Solid"	131
4745	tray insert "Solid"	131
4746	tray stand "Solid"	128
4747	connector piece "Solid"	128
4748	tray stand/side table "Solid"	137, 299
4762.18	storage/presentation box "Solid"	265, 296, 300
4762.18G	glass lid	265, 296, 300
4763.01S	insert for chocolates	265, 301
4763.01W	insert for chocolates	265, 301
4763.02S	insert for cigars	265, 296, 301
4763.03S	insert for coffee capsules	265, 301
4763.04W	insert/platter	265, 301
4766	cutlery/napkin box "Solid"	188, 262, 300
4767.12	buffet display "Solid"	40, 134, 148
4767.24	buffet display "Solid"	40, 134, 148
4768.08	buffet display/basket "Mercato"	126
4768.12	buffet display/basket "Mercato"	126
4768.16	buffet display/basket "Mercato"	126
4769	serving tray "Solid"	136, 147, 256, 298
4770.24	bread basket "Solid"	135, 260
4773	bed tray "Solid"	136, 255, 299
4774.31PB	cutting/snack board "Connect!"	134, 259
4775.44PB	cutting/snack board "Connect!"	134, 259
4776	cutting board "Solid"	122, 132
4777	stacking ring "Solid"	122
4778	bowl "Solid"	122
4780.46	serving tray "Solid"	135, 258
4780.46S	insert/platter	135, 258
4780.67	serving tray "Solid"	135, 258
4780.67S	insert/platter	135, 258
4810.01	bowl	93
4810.02	bowl	93
4813.28	glass bowl "Duplex"	90
4813.35	glass bowl "Duplex"	90
4813.46	glass bowl "Duplex"	90
4814.17	glass bowl	29, 72, 91, 232, 234
4814.23	glass bowl	29, 72, 91
4814.30	glass bowl	29, 72, 91
4814.40	glass bowl	29, 91
4815.18	glass bowl "Cave"	90, 184
4815.24	glass bowl "Cave"	90, 184
4848	glass cloche/wine cooler	108, 124, 194,

quick-finder – list of ascending order

item	description	page
5184.25	glass plate "Gelo"	160
5184.30	glass plate "Gelo"	160
5185.09	glass bowl "Gelo"	160, 240
5185.14	glass bowl "Gelo"	160, 240
5185.21	glass bowl "Gelo"	160
5185.27	glass bowl "Gelo"	160
5186.14	coup plate "Bolla"	164
5186.18	coup plate "Bolla"	164
5186.22	coup plate "Bolla"	164, 268
5186.26	coup plate "Bolla"	164
5210	ashtray for cigars	120, 244, 296
5241	buffet platter Curve 90"	63
5243	buffet platter, clear glass	63, 112, 117
5243.M	buffet platter, satined glass	63, 112, 117
5244	coaster/glass insert	76, 192, 238, 260, 266
5244.17	coaster/glass insert	76, 125, 193, 195, 261, 266
5244.21	coaster/glass insert	76, 125, 193, 194, 195, 261, 266, 268
5244.24	coaster/glass insert	76, 125, 193, 195, 261, 266
5244.28	coaster/glass insert	16, 18, 76, 125, 193, 195, 261, 266
5254	small glass bowl	154, 242, 288
5254.01	glass miniature	242, 288
5255	small glass creamer	242, 288
5257	glass miniature	154, 245
5290.01	glass bottle	243
5290.02	glass bottle	243, 291
5295.01	glass bottle	243, 288
5295.02	glass bottle	243, 289
5296.01	glass bottle	243, 288
5296.02	glass bottle	243, 288
5297.01	cork	243, 288
5297.02	cork	243, 288
5308.08	glass bowl	245
5308.11	glass bowl	245
5317	vinegar/oil bottle	282
5330.08	glass bowl	244
5338	small bowl	242, 289
5338.01	glass miniature	242, 289
5349.21	pastry/cake stand	124, 196
5349.28	pastry/cake stand	124, 196
5349.33	pastry/cake stand	124, 196
5350.16	glass cloche	124, 196
5350.23	glass cloche	124, 196
5350.27	glass cloche	124, 196
5380	glass	179, 245, 291, 292
5405	glass miniature	104, 154, 245, 283
5415	glass cone	106, 238, 280
5416	small glass creamer	245
5418	small glass bowl/cloche	179, 197, 232
5423.01	glass miniature	154, 240
5423.02	glass miniature	154, 240
5424	small butter & lard pot	244
5428.04	glass tray	244, 281
5444	glass bowl	146, 245, 291
5445	glass miniature, 2 parts	240

item	description	page
5446.01PB	glass pillow "Donna"	181, 240, 305
5478	wine glass lid "Tesoro"	206, 232
5478-06	wine glass lid "Tesoro"	206, 232
5480.01	FRESH	204
5480.01-1	FRESH	204
5480.02	STRAIGHT	204
5480.02-1	STRAIGHT	204
5480.03	INTENSE	204
5480.03-1	INTENSE	204
5480.04	BALANCED	204
5480.04-1	BALANCED	204
5480.05	RICH	205
5480.06	NOSTALGIC	205
5480.07	SIDE	205
5660	hook-and-loop strap	107
5661.02	VISION presentation case	208
5662	hand pump	46
5663.20	cooling pack	54, 184, 241
5664	glasses polishing cloth	208
5667.01	transport trolley	36
5667.02	transport trolley	36
5700	glass plate	87, 175
5701	glass bowl	87, 175
5702	glass plate	87, 175
5703	buffet bowl	87
5704	buffet bowl	89
5740	glass bottle/creamer	243, 284, 288
5741	miniature glass bottle	243, 284
7002.12	buffet display "Neo"	50
7002.24	buffet display "Neo"	50
7002.36	buffet display "Neo"	50
7005.16	buffet display/icebox "Neo"	50
7030	drip tray	223, 273, 302
7106.46	bowl "Capiz"	78
7109.46	bowl "Capiz"	78
7112.36	bowl "Capiz"	78
8004.01	buffet platter, clear glass	63
8004.02	buffet platter, clear glass	63
8004.03	buffet platter, clear glass	63
8004.04	buffet platter, clear glass	63
8004.05	buffet platter, clear glass	63
8004.06	buffet platter, clear glass	63
8005.01	buffet platter, slate	62
8005.04	buffet platter, slate	62
8005.21	buffet platter, slate	62
8006.01	buffet platter, laminated plastic	58
8006.02	buffet platter, laminated plastic	58
8006.04	buffet platter, laminated plastic	58
8006.06	buffet platter, laminated plastic	58, 189
8006.08	buffet platter, laminated plastic	58, 112, 114, 117, 278
8006.11	buffet platter, laminated plastic	58
8006.13	buffet platter, laminated plastic	58
8006.14	buffet platter, laminated plastic	58, 114, 278
8006.15	buffet platter, laminated plastic	58, 114, 278

item	description	page
8007.01	buffet platter "Industry 2.0"	59
8007.02	buffet platter "Industry 2.0"	59
8007.04	buffet platter "Industry 2.0"	59
8007.06	buffet platter "Industry 2.0"	59, 189
8007.08	buffet platter "Industry 2.0"	59, 112, 117
8007.11	buffet platter "Industry 2.0"	59
8007.13	buffet platter "Industry 2.0"	59
8010.01	buffet platter, laminated plastic	22, 58
8010.02	buffet platter, laminated plastic	22, 58
8010.03	buffet platter, laminated plastic	22, 58
8013	buffet etagere "Stablo"	113
8014.13	buffet stand "Stablo"	111
8014.20	buffet stand "Stablo"	111
8014.20PB	decanter dry rack "Stablo"	222
8015.20	buffet stand "Stablo" S, M, L	111
8015.30	buffet stand "Stablo" S, M, L	111
8015.40	buffet stand "Stablo" S, M, L	111
8016.01	buffet stand "Stablo" XL-ring	110, 224
8017.40	extension "Stablo"	110, 224
8017.60	extension "Stablo"	110, 224
8017.80	extension "Stablo"	110, 224
8018.01	fingerfood tree	107
8018.T	transport bag	107
8019.01	spring clip support	106
8019.02	ring support	106
8019.03	ring support	106
8019.04	ring support	106
8019.05	spiral support	106
8051	skewer plate, slate	105, 251
8054	platter, slate	105, 251
8056	platter, slate	105, 251
8057	bowl "On The Rocks"	185, 221
8058	coaster "On The Rocks"	185, 221
8059.PB	wine/decanter cooler "On The Rocks"	185, 221
8081.13	buffet stand "Squareline"	39
8081.25	buffet stand "Squareline"	39
8082.13	buffet stand "Squareline"	39
8082.25	buffet stand "Squareline"	39
8083.01	acrylic connector "Squareline"	39
8083.02	acrylic connector "Squareline"	39
8084.13	buffet stand "Squareline"	39
8084.25	buffet stand "Squareline"	39
8086	etagere "Falcon"	114, 278
8120.01	acrylic glass tube	38, 52
8120.02	acrylic glass tube	38, 52
8120.03	acrylic glass tube	52
8122.10	acrylic glass tube	34, 52
8122.22	acrylic glass tube	34, 52
8122.34	acrylic glass tube	34, 52
8122.58	acrylic glass tube	34, 52
8150	rechargeable LED-light	53
8151	remote control	53
8152.EU	charging device for rechargeable LED-light	53
8152.UK	charging device for rechargeable LED-light	53

item	description	page
8152.US	charging device for rechargeable LED-light	53
8153.01PB	base ring with LED-light	220
8200.12D	buffet display "Konkret!"	47
8200.12L	buffet display "Konkret!"	47
8200.24D	buffet display "Konkret!"	47
8200.24L	buffet display "Konkret!"	47
8200.36D	buffet display "Konkret!"	47
8200.36L	buffet display "Konkret!"	47
8206.08	buffet display "V12"	44
8206.16	buffet display "V12"	44
8206.24	buffet display "V12"	44
8210.04D	buffet display "Konkret!"	47
8210.04L	buffet display "Konkret!"	47
8210.08D	buffet display "Konkret!"	47
8210.08L	buffet display "Konkret!"	47
8210.12D	buffet display "Konkret!"	47
8210.12L	buffet display "Konkret!"	47
8210.16D	buffet display "Konkret!"	47
8210.16L	buffet display "Konkret!"	47
8210.20D	buffet display "Konkret!"	47
8210.20L	buffet display "Konkret!"	47
8212.D	XXL bowl "Konkret!"	46
8213	rack for XXL bowls	46, 89
8221.08	buffet display "Luxor"	42
8221.16	buffet display "Luxor"	42
8221.24	buffet display "Luxor"	42
8230.08	buffet display "Classy"	49
8230.16	buffet display "Classy"	49
8230.24	buffet display "Classy"	49
8231	buffet display "Classy"	48
8232.24	buffet display "Textura"	26
8232.30	buffet display "Textura"	26
8240.08	buffet display "Stompl!"	16
8240.16	buffet display "Stompl!"	16
8240.24	buffet display "Stompl!"	16
8242.08	buffet display "Sagano"	18
8242.16	buffet display "Sagano"	18
8242.24	buffet display "Sagano"	18
8250.15	buffet display "Époques"	14
8251.30	buffet display "Époques"	15
8252.50	buffet display "Époques"	15
8253.30	buffet display "Époques"	14
8305.10	buffet stand "Skyline"	34
8305.22	buffet stand "Skyline"	34
8305.34	buffet stand "Skyline"	34
8305.58	buffet stand "Skyline"	34
8310.22	buffet stand "Curve"	32
8310.46	buffet stand "Curve"	32
8320.15	buffet stand "Crossline"	31, 89
8320.15R	buffet stand "Crossline" - rust	30
8320.31	buffet stand "Crossline"	31, 89
8320.31R	buffet stand "Crossline" - rust	30
8325.23	buffet stand "Crossline"	31, 88
8325.23R	buffet stand "Crossline" - rust	30
8400.16	LED display "Glow" S	22
8400.24	LED display "Glow" M	22
8400.32	LED display "Glow" L	22
8405.16	LED frame "Glow"	22

quick-finder – list of ascending order

item	description	page
8405.24	LED frame "Glow"	22
8410.16	connecting board "Glow" L	22
8410.24	connecting board "Glow" M	22
8412	cable holder	25
8414	spacer/buffer	22
8416	power supply for LED displays and -frames "Glow"	24
8416.EU	plug for power supply 8416	24
8416.UK	plug for power supply 8416	24
8416.US	plug for power supply 8416	24
8418.01	connecting cable "Glow"	24
8418.02	connecting cable "Glow"	24
8430.05	buffet display "Scala"	10
8432.10	buffet display "Scala"	10
8434.10	buffet display "Scala"	10
8436.15	buffet display "Scala"	10
8438.20	buffet display "Scala"	11

FOR WINE LOVERS



item	description	page
2231.PB	decanter dry rack/display "DryPod" with drip tray	223
2233.PB	decanter dry rack/display "DryPod" with drip tray	223
4884.PB	decanter/carafe "Eddy" with ring	217
4890.PB	decanter/carafe "Pebble"	218
4891.PB	decanter/carafe "Eddy" - mini	216
4892.PB	decanter "Eddy" - mini with Vision "Straight"	216
4894.PB	decanter/carafe "Doppio"	212
4945.PB	decanter/carafe "Star" - mini	214
4946.PB	decanter/carafe "Star" - mini with Vision "Straight"	214
4948.PB	decanter/carafe "Star" with base	215
5478	wine glass lid "Tesoro"	206
5480.01	FRESH	204
5480.01-1	FRESH	204
5480.02	STRAIGHT	204
5480.02-1	STRAIGHT	204
5480.03	INTENSE	204
5480.03-1	INTENSE	204
5480.04	BALANCED	204
5480.04-1	BALANCED	204
5480.05	RICH	205
5480.06	NOSTALGIC	205
5480.07	SIDE	205
5661.02	VISION presentation case	208
5664	glasses polishing cloth	208
8014.20PB	decanter dry rack "Stablo"	222
8059.PB	wine/decanter cooler "On The Rocks"	221
8153.01PB	base ring with LED-light	220



notes

item	page	notes

item	page	notes

quick-finder – A to Z glossary

A	
acrylic adapter SQUARELINE	39
acrylic tubes	34, 38, 52
amuse gueule/tapas spoon	152, 153, 247
anti-slip pads	100, 233
ART DE BUFFET	80-83
ARTISAN	84, 85
ashtray	296
B	
BALANCED	204
BAR COLLECTION	226-230
base station for rechargeable LED-light	53
base trays MODUL	143, 148, 150
basic ring with LED-light for decanters	220
basket MERCATO	126
baskets/bowls, pewter	70-74, 234
bed tray SOLID, walnut	136, 255, 299
BENTO BOX, melamine	140, 254
black glass	60, 65
BOLLA	164
borosilicate glass	104, 106, 110, 192, 206, 212-217, 224, 228-238
BOSQUE	156, 157
bottles, glass	243
bowls, brass	73, 76, 77, 266
bowls, ceramics	157
bowls, china	162, 170, 180-187
bowls, glass	29, 31, 87-93, 158-161, 164-166, 172-175, 184, 245
bowls, shell	78
bowls, stainless steel	80-86
bowls, walnut	122, 134, 135
bowl, XXL	46, 87-89
bowls/baskets, pewter	70-74, 232, 234
boxes, glass	288, 289
boxes, melamine	138-143, 252-254
boxes, walnut	134, 138, 147, 188, 252, 253, 287
bread basket/box, walnut	40, 122, 126-131, 135, 260
bread basket/pastry bowl, stainless steel	84
bread cutting board, walnut	122, 132, 134, 259
buffer/spacer for GLOW	22
buffet bowls	68-93
buffet bowls, brass	73, 76, 77, 266
buffet bowls, ceramics	157
buffet bowls, glass	29, 31, 87-93, 158-161, 164-166, 172-175, 184, 245
buffet bowls, pewter	70-74
buffet bowls, shell	78
buffet bowls, stainless steel	79-86
buffet bowls, walnut	122, 134, 135
buffet display, aluminium	8-11
buffet display, bamboo	22
buffet display, brass	28, 29, 96-99
buffet display, carbon	44
buffet display, illuminated	20-27, 34-39, 48-52
buffet display, polyethylen	26

buffet display, resin	16-19, 42, 48-51
buffet display, shell	42
buffet display, stainless steel	34-39, 108-119
buffet display, stone look	46-49
buffet display, wood	12-19, 40, 122-138
buffet displays/riser	7-52, 98-119, 122-137
buffet etageres	84, 94, 128-133
buffet platters, glass	60-64, 113-117
buffet platters, laminated plastic	58, 59
buffet platters, overview	56
buffet platters, slate	62
buffet sign	120
buffet steps	64
buffet systems	8-52, 106-115, 122-138
buffet systems/overview ZIEHER SYSTEM	41
buffet trays	25, 64, 65, 75, 85, 125-150
butter/lard pot	244

C	
cable GLOW	24
cable holder GLOW	25
cake-/pastry stand	124, 196
candle holder/windlights	294-296
CAPIZ	78
carafes/decanter	210-218
card holders	120, 135, 260
CAVE	184, 241
ceramic insert	135, 258
ceramic series BOSQUE	157
champagne/wine cooler	46, 78, 89, 108-111, 185, 224, 225, 260, 261
charger plates	189
CHILLER BASE	54
china ball ORO79	187
china bowls	162, 170, 180-187
china creamer	242, 246
china miniatures	235, 242, 246, 247
china plates	152, 156, 162, 168, 170, 180-182, 186, 187
china platters	168, 179-182, 187
china spoon	247
chocolate/icecube tongs	121
chocolate insert SOLID	256, 301
chocolate truffle box SOLID	264
cigars insert SOLID	265, 301
CLASSY	48, 49
cloches	122-125, 170, 190-197, 235
cocktail glass	226-231
coffee cups	237
collina	179, 305
CONNECT!	134, 259
connecting cable GLOW	24
cooling pack for CHILLER BASE	54, 184, 241
cooling platters CHILLER BASE	54
connection board GLOW	22
cork	154, 230, 238
coup plates	164, 166
creamer, glass	242, 243, 282
creamer, china	242, 246

CROSSLINE	30, 31
cruet stands, stainless steel	282-286
cups, doublewalled	236, 237
CURVE	32
CUSPIS	170, 190, 235
cutlery insert SOLID, walnut	131
cutlery/napkin box	138, 142, 143, 147
cutting boards, walnut	122, 128, 132, 134, 251, 259

D	
dash bottle EDDY dash!	230, 284, 292
decanter cooler ON THE ROCKS	185, 221
decanter pedestal for illumination	220
decanter/carafes	210-218
DONNA	181, 240, 305
DOPPIO	212
double-walled bowls	46, 78, 86, 236, 237
double-walled glasses	236, 237
DRESSCOAT	94, 182, 277, 304
drip tray DRYPOD	223, 273, 302
drop pourer	230, 284, 292
dry rack for decanters	222, 223
DRYPOD	223, 273, 302
DUPLEX	90

E	
EDDY - EDDY mini	216, 217
EDDY dash!	230, 284, 292
ÉPOQUES	12-15
etageres for the buffet	84, 94-119, 128-133
etageres for the table	268-278
etageres DRESSCOAT	94
etagere FALCON	114, 278
Étagere FLEUR DÉCO	96-99, 268, 269, 303
etagere FLOWER TOWER - TABLE TREE	102, 103
etageres FLOWER TREE - FLEX TREE	100, 101, 271
extension STABLO	110, 224

F	
FAKIR	76, 266
FALCON	114, 278
FINGERFOOD TREE	107
FLEUR DÉCO	96-99, 268, 269, 303
FLEX TREE	100, 271
FLOWER TOWER etagere	103, 272
FLOWER TREE	101, 271
food display, stainless steel	280
FRESH	204
fruit/bread basket REEF	70-72
fruit/bread basket SKYLINE	35
fruit/bread basket SOLID	122, 134, 135, 287
fruit/bread basket, stainless steel	35, 80-86

G	
GELO	160
glass bottles	243
glass bowls	29, 31, 87-93, 158-161, 164-166, 172-175, 184, 245
glass cloches	122-125, 170, 260-263
glass platters	60-64, 113-117, 158, 172-178

glass, double-walled	236, 237
glass miniatures	232-245
glass insert	76, 125, 189, 192-195, 260
glass plates	158-166, 174-176, 189
glass polishing cloth	208
glass saucer	76, 125, 192-195, 260-263
glass series VISION	200-209
glass steps	64
glass trays	130, 143
glass wind lamp	294-296
GLOW	20-25
GN trays	130, 143
grey glass	64, 87-91, 113, 174-176, 178

H	
HALFMOON	236
handpump	46
holder for table numbers	120, 135, 260
holder for test tubes	280
hook and loop strap for FINGERFOOD TREE	107

I	
ice bucket NEO	50
ice cube/chocolate tongs	121
icecream cup	103, 272
INDUSTRY 2.0 buffet platters	59
insert for chocolates SOLID	265, 301
insert for cigars SOLID	265, 301
insert for coffee capsules SOLID	265, 301
insert for serving tray SOLID, walnut	130, 131, 135
INTENSE	204

J	
jam trays	244, 248, 281
juice glass	205, 228, 229, 237, 245

K	
KNOBBED	228
KONKRETI	46, 47

L	
laminated plastic platters	22, 58, 59
lard pot	244
LEAF	73, 234
LED display and frame GLOW	22
LED-light, rechargeable	53
LED pedestal for decanters	220
lid TESORO	206, 232
LIGHTNING BUFFET	52
LINEA	172
LOOP	81
LUXOR	42

M	
marble cooler ON THE ROCKS	185, 221
MATRIX	76
MEDUSA	79
melamine BENTO BOX	140, 254
melamine boxes	138-143, 252-254

melamine bridge	146, 150
melamine cutlery/napkin box	138, 142, 153, 252
melamine spoon rest	146, 150
melamine trays	140-146, 150, 254, 290
MÉNAGE À TROIS	285
MERCATO	126
MIKADO	108, 225
miniatures, melamine	252
miniatures	231-252
miniatures, china	235, 241, 242, 246, 247
miniatures, glass	232-245
miniatures, stainless steel	248-250
MODUL	148-154, 180

N	
napkin ring	188
napkin/cutlery box	138, 142, 143, 147
NEO	50
nosing lid TESORO	206, 232
NOSTALGIC	205

O	
OMBRA	58
ON THE ROCKS	185, 221
ORBIS	75, 267
ORO 79	187

P	
party spoons	152, 153, 147
pastry/bread bowl, stainless steel	84
pastry/cake stand	124, 196, 197
PEBBLE	218
pedestal/ring, for illumination	220
pepper mill	288
petit four stand	94-107, 197, 249-252, 266-272
pewter	70-74, 188, 232, 234
PILL	229
plateau plate CUSPIS, china	170
plateau plate DRESSCOAT, china	94, 182, 277, 304
plates, ceramic	157
plates, china	152, 156, 162, 168, 170, 180-182, 186, 187
plates, glass	158-166, 174-176, 189
plate/saucer, wood	125, 192-195, 260, 261
platters, china	168, 179-182, 187

platters, glass	60-64, 113-117, 174-180
platters, laminated plastic	58, 59
platters, slate	62, 105, 250, 251
polishing cloth	208
power supply for GLOW	24
presentation box SOLID	262-264
presentation case VISION	208
protecting cap for SOMNIA displays	29
PULSAR	168
pump for meltwater	46

R	
rack for XXL-bowl KONKRETI	46, 89
rechargeable LED-light	53
REEF	70-72, 234, 294
remote control for rechargeable LED-light	53
RICH	205
ring, silicone	91, 110, 197, 217, 220-225
riser/buffet displays	7-52, 98-119, 122-137
roomservice tray SOLID, walnut	136, 255, 299
ROOTS	76

S	
SAGANO	18
salt/pepper mills	288
saucer, glass	76, 125, 192-195, 261-263
saucer, silicone	100, 233, 271
saucer, wood	125, 192-195, 260, 261
SCALA	8-11
serving etageres	268-272
serving tongs	121
serving tray with ceramic insert	135, 258
serving trays, brass	75, 99, 267, 269
serving trays, melamine	140-146, 150, 254, 290
serving trays, wood	130-137, 147, 148, 255-259, 287
shell displays LUXOR	42
shell series CAPIZ	78
SHINE	86
SIDE	205
side table/tray stand SOLID	137, 299
silicone holder for test tubes	154, 233, 280
silicone pads/coasters	100, 233, 271
silicone rings	91, 110, 197, 217, 220-225

T	
TABLE TREE Flower & Pin	102, 270
TESORO	206, 232
test tube	238, 280
TEXTURA	26
THE BAR COLLECTION	226-230
thermo bowls SHINE	86
thermo glass	236, 237
toast stand, stainless steel	120, 281
tongs holder, stainless steel	121

SIXTH SENSE	81
skewer platters	105, 107, 243, 250
skewers, stainless steel	104, 153, 242, 248, 250
SKYLINE	33-36
slate platters	62, 105, 250, 251
SOLID	40, 122-138, 255-265, 287, 296-300
SOMBRE	162
SOMNIA	28, 29, 295
spacer/buffer for GLOW	22
spiral support for miniatures	104, 250
SPLASH	74
spoon rest, melamine	150
spoon rest, wood	148
spoon rests	121, 146, 148
SQUARELINE	37-39
STABLO	109-113
stacking bowl SOLID	122
stacking ring SOLID	122
stainless steel bowls	79-86, 248, 249
stainless steel cruet stands	282-286
stainless steel skewers	104, 153, 248-250
stainless steel tongs	121
stainless steel trays	85, 112, 117-120, 248, 274-281

stainless steel, hammered	79-85, 116-121, 248, 249
stand for trays SOLID	128, 299
STAR - STAR mini	214, 215
steps, glass	64
STOMPI	16
storage/transportation trolley	36
STRAIGHT	204
strap for FINGERFOOD TREE	107
supports for FINGERFOOD TREE	106
sushi platters	172-178, 187

stainless steel, china	152, 156, 162, 168, 170, 180-182, 186, 187
stainless steel, glass	158-166, 174-176, 189
stainless steel, stainless steel	125, 192-195, 260, 261
stainless steel, wood	125, 192-195, 260, 261
stainless steel, glass	158-166, 174-176, 189
stainless steel, glass	158-166, 174-176, 189
stainless steel, wood	125, 192-195, 260, 261
stainless steel, glass	158-166, 174-176, 189
stainless steel, wood	125, 192-195, 260, 261
stainless steel, glass	158-166, 174-176, 189
stainless steel, wood	125, 192-195, 260, 261
stainless steel, glass	158-166, 174-176, 189
stainless steel, wood	125, 192-195, 260, 261
stainless steel, glass	158-166, 174-176, 189

stand for trays SOLID	128, 299
STAR - STAR mini	214, 215
steps, glass	64
STOMPI	16
storage/transportation trolley	36
STRAIGHT	204
strap for FINGERFOOD TREE	107
supports for FINGERFOOD TREE	106
sushi platters	172-178, 187

tongs, stainless steel	121
transportation/storage trolley	36
transport bag for FINGERFOOD TREE	107
tray inserts SOLID	130, 131, 135
trays, glass	65, 113, 176, 178
trays, melamine	140-146
trays, stainless steel	85, 112, 117-120, 248, 274-281
tray stand/side table SOLID	128, 299
tray stands SOLID	137, 299
trays with ceramic insert	135, 258
trays, brass	75, 99, 267, 269
trays, wood	130-137, 147,



"Stomp" | p. 16/17



NEW

"Fleur Déco" | p. 96-99



"Skyline" | p. 33-36



"Textura" | p. 26/27



"Reef" | p. 70-72

BUFFET Inspirations

"Glow" | p. 20-25



"Classy" | p. 48/49



"Somnia" | p. 28/29



NEW

"Scala" | p. 8-11



"Sagano" | p. 18-19



"Konkret" | p. 45/47



NEW

"Époques" | p. 12-15



"Solid" | p. 122-138

Making precious materials more precious – whether it is glass, china ...



"platin"



"gold"



"bronze"



Please note:

Products are dishwasher-resistant. Please take note of the instructions given by dishwasher producers and detergents to avoid damage. Since the coatings are made of precious metals, the use in microwaves is not recommended under any circumstances.

Large-scale coatings on glass and china in precious colours enrich every dining table and create luxurious accents!

In order to achieve this decorative style, available in gold, platinum and bronze, the precious metals are burnt onto the varnish at more than 880 °C and as a result, the coating is dishwasher-safe. Cloches made of glass can now be used for serving warm dishes as well and condensing water remains invisible to a great part.

By using resistant precious alloys, we obtain a connection to the varnish, which is strong enough for the products to become dishwasher-safe. Test series by the "Institut für Werkstoffe Heraeus Precious Metals GmbH & Co. KG" have proven the dishwasher resistance of the decor. Partially, the possibilities of coating are dependent on the form of the product. Requests are being tested in each case according to their feasibility.

The bronze colour is a special case since it presents itself in numerous interesting shades of colour. Depending on the shape of the product, especially when looking at immersions, the colours can vary from gold-bronze shades to blue-violet ones, which blend into each other and create unique effects. Specific patterns/orders are usually executed quickly.

Please do not hesitate to send us your special request.



Satin-coated logos applied before the refinement still remain visible!

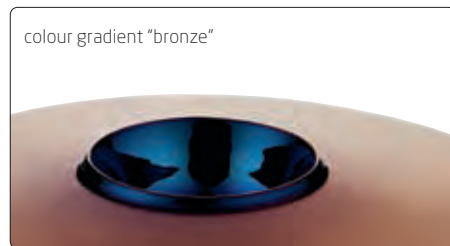

colour gradient "bronze"



stainless steel, polished

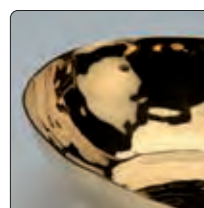

golden

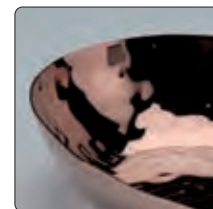

copper

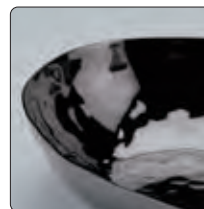

black

... or stainless steel – nearly everything is possible!



Stainless steel refinement through PVD-technology

Highly polished and matt stainless steel can be refined by using PVD-technology to obtain golden, copper and black colouring.

PVD stands for **Physical Vapour Deposition** and describes a method to coat products with different materials by way of sputtering in a vacuum. Contrary to the galvanic refinement, for example with copper, items refined by using PVD-technology will neither oxidise nor tarnish at the surface. Thus any copper refinement can be done without applying specific anti-tarnish protection. The technical feasibility of PVD-refinement depends on size and shape of the items and has to be checked individually.

Price, minimum order quantity and delivery time upon request!

Individuality in glass ...



For designs on double-walled glasses, it is possible to apply the print on the outside of the inner glass. In this way, the print is fully protected against abrasion and wear.

... melamine ...



... china ...



... and stainless steel!



Advantages of the PVD-coating:

- Food-safe
- Dishwasher-safe
- Better strength and adherence compared to galvanic refinement
- Brilliant colouring, colourfast and resistant against UV radiation

We will be delighted to advise you!



Powder-coating:

All items made of stainless steel can be powder-coated in all current RAL colours upon request. In contrast to the PVD refining, this coating is not dishwasher-safe.



Our partners, fans and friends, among them many top chefs and sommeliers from all over the world, are using Zieher products to stage drinks and dishes and to present them on social media.

Below is a great collection of very special Zieher moments. Thanks so much for your creativity!

#ziehermoment

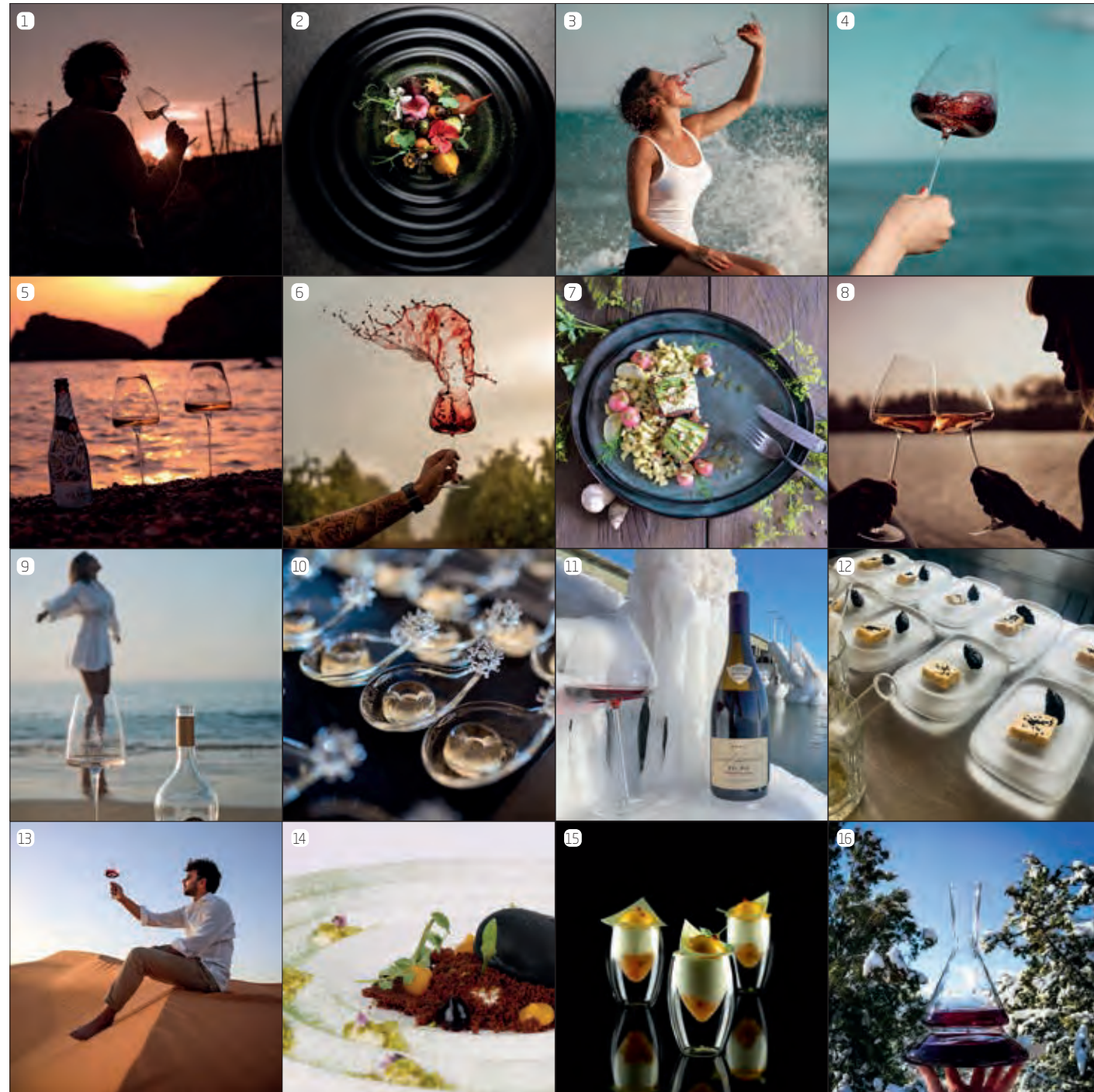

1, 5, 13, 23 Andrea Zigrossi | 2, 25 Hane Garza Workshop TallerJO, Monterrey, Mexico | 3, 4 Elisa Dublyanska | 6, 18 Gilbert Bages [instagram.com/drinkinmoderation](https://www.instagram.com/drinkinmoderation) | 7 Eat, Letters & Deco [eatlettersanddeco.com](https://www.eatlettersanddeco.com) | 8 WeinBaum [@instagram.com/weinbaum.de](https://www.instagram.com/weinbaum.de) | 9 [instagram.com/naturesteve](https://www.instagram.com/naturesteve) | 10 Best Events Catering | 11, 28 Rasmus Christensen [Winewherever](https://www.winewherever.com) | 12 Daniel Klein Restaurant [KOOK] 36 in Moos | 14, 22 Marcel Thiele [instagram.com/thiele.marcel](https://www.instagram.com/thiele.marcel) | 15, 20 Fabian Sanger Sweet Life Rezepte fur Patisserie, [fabiansaenger.dom](https://www.fabiansaenger.dom) „GORMAND world awards“ | 16, 26 Francesco Ciardullo [@instagram.com/ciardulloofficial](https://www.instagram.com/ciardulloofficial) | 17, 27 Ulric Nijs [bar-face.com](https://www.bar-face.com) | 19 eat! Berlin bei Kunst&Kulinarik | 21 India Donisi [instagram.com/winespicegirl](https://www.instagram.com/winespicegirl) | 24 Enrico Onthewine | 31 Vincenzo Lanzilotti | 29 Elena Vinyarskaya [@instagram.com/readmeawine](https://www.instagram.com/readmeawine) | 30 Andy Gaskin [instagram.com/kitchenandy0808](https://www.instagram.com/kitchenandy0808) | 32 Maren Lubbe

Follow us on social media and stay tuned!



facebook.com/ZieherGermany



[instagram.com/Zieher_Selection](https://www.instagram.com/Zieher_Selection)



[linkedin.com/company/zieher-kg](https://www.linkedin.com/company/zieher-kg)



[xing.com/companies/zieherkg](https://www.xing.com/companies/zieherkg)



[pinterest.de/zieherkg/](https://www.pinterest.de/zieherkg/)



[youtube.com/user/ZieherGermany](https://www.youtube.com/user/ZieherGermany)



[zieher.com/blog/](https://www.zieher.com/blog/)

ZIEHER excellence since 1986

a success story with a future



Founding years and establishment as gastronomic partner

1986 - 2005

The company was founded in 1986 by Manfred Zieher and his wife Christa. Classic catering products were offered under the name MAC, which were soon presented in their own catalogues and at trade fairs.

The company, which increasingly established itself as partner of gastronomy specialised shops, was given the name ZIEHER in 1994. The prominent brand logo was registered in 2004 as a word and figurative mark.



Zieher for Wine Lovers

Since 2015

The cornerstone for a collection for ambitious wine lovers was laid in 2015 with the VISION series. These unique wine glasses have been developed together with sommelier Silvio Nitzsche from Wein | Kultur | Bar Dresden, as a counterpart to the previously common red and white wine glasses. As of 2017, the range has been extended with extraordinary decanters such as "Eddy" and "Star", and supplemented by further functional wine accessories such as "Tesoro". The exclusive FOR WINE LOVERS collection is also available to end customers through high-quality specialist retailers.



Silvio Nitzsche



Extravagance designed by Zieher

Since 2006

The first Zieher designed products were released in 2006. Individual creations in the luxury segment emerged from the close cooperation with renowned chefs and the inspiration by their artistry. Besides the cooperation with well-known Designers such as Itamar Harari for instance, many products bear the signature of Oliver Zieher. In 2009, "Skyline" - a benchmark for extremely flexible buffet systems - has been developed.

Since 2014, Zieher presents its newly designed showroom in Himmelkron near Bayreuth, right at the motorway to Berlin.

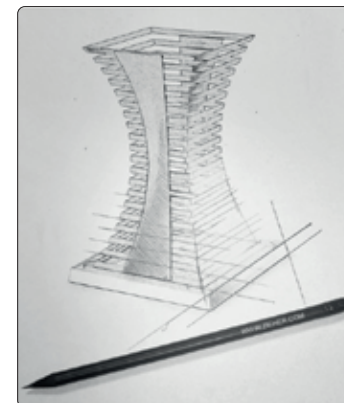

Zieher today

In 2024, Zieher is present in 5-star-hotels and top restaurants in more than 100 countries and appreciates the long-lasting, often amicable relationship with clients, partners and suppliers.

The success story continues

Generational change 2021

Zieher is increasingly focusing on its strengths and is positioning itself with a streamlined range as an extravagant design manufacturer for luxury food presentation and wine glasses. In 2021, the generational change has been carried out and the company has been handed over to the children Dominik Zieher, Jennifer Hübsch and Oliver Zieher (Itr).

Manfred and Christa Zieher receive the Lifetime Achievement Award from the renowned industry magazine TableWare International for their life's work.





 WWW.ZIEHER.COM
www.zieher.com/en/catalogues/

WWW.ZIEHER.COM



All catalogues

ZIEHER KG

Kulmbacher Straße 15
95502 Himmelkron
Germany

Phone +49 9273 / 92 73 40
E-mail info@zieher.com

KATpro0324GB

Valid until February 28th, 2025

FOR
WINE
LOVERS

ZIEHER





@trotterwine

Silvio Nitzsche

www.weinkulturbar.de

For more than 30 years, Silvio Nitzsche has looked after both the guests and the wine as a sommelier, amongst others in some of the best Michelin-starred restaurants.

Some of his most high-profile positions have been:

Sommelier at "Dieter Müller Restaurant" (19.5 GM, *** Michelin), Bergisch Gladbach / GER

Sommelier at "Erna's Elderberry House", Oakhurst / CA, USA

Assistant Restaurant Manager and Sommelier at "Speisemeisterei" Restaurant (18 GM, ** Michelin), Stuttgart / GER

Management of the wine retail and wholesale company KierdorfWein

In 2007, the sommelier found a new home in Dresden. Opening the WEIN | KULTUR | BAR he and his team managed to establish one of the best wine bars in Europe in the wine consciousness of many. He has succeeded in creating a place where wine is a given. It is not for nothing that he has already won the "Best Wine List of the Year" award six times.

In his professional life he has received numerous awards for his work and for his company. Silvio has been voted one of the ten best sommeliers in Germany by "Der Feinschmecker" magazine several times and was awarded the "Award of Honor" in 2019. He was recently named "Sommelier of the Year" by Falstaff magazine.

The WEIN | KULTUR | BAR is listed in Gault & Millau and is quoted by Falstaff BARGUIDE 2024 as Germany's best wine bar.



“ OF COURSE,
THERE IS LIFE
WITHOUT WINE,
BUT WHO
WANTS THAT? ”

The VISION of simplicity

No distinction is made between red wine or white wine glasses in this collection, the glasses are simply theme- or character-based. The names of the glasses FRESH, STRAIGHT, INTENSE, BALANCED, RICH, NOSTALGIC and SIDE clearly explain what they are used for. You intuitively reach for the glass, which in the best way presents the flavours of the wine that you particularly wish to emphasise. If you want a powerful wine to be more harmonious or a touch more lively and fresh, you pick the glass with the designation, that mirrors your requirement best.

VISION

"You have never seen wine like this!"

Silvio Nitzsche, WEIN | KULTUR | BAR Dresden



For further information about the VISION series, philosophy and a far-reaching analysis of the sommelier Silvio Nitzsche, please visit www.zieher-selection.com/en/vison



SIDE

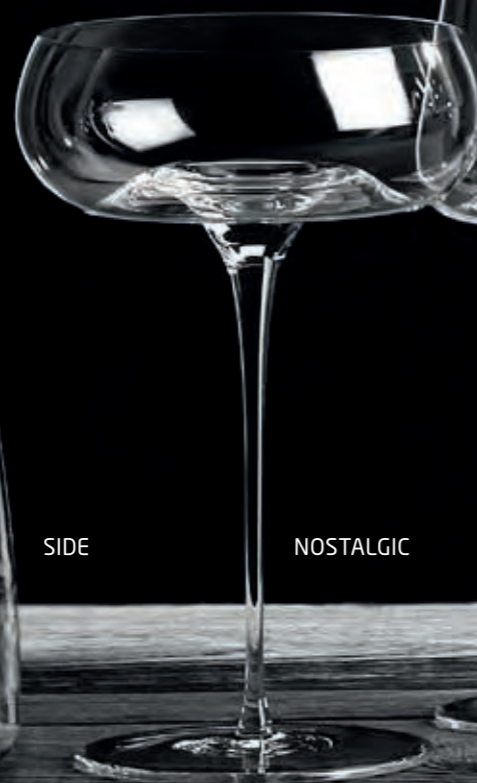

NOSTALGIC



RICH



STRAIGHT



FRESH



BALANCED



INTENSE



Traditional glass-blowing

Filigree craftsmanship meets innovative design

Zieher glasses are all about top quality craftsmanship, which is created in one of the most innovative and best glass blowing workshops in the world. The glasses are manufactured of lead-free crystalline glass, using a traditional glass-blowing method. Each glass is unique and has been created by a glass blower with artistry and dedication.

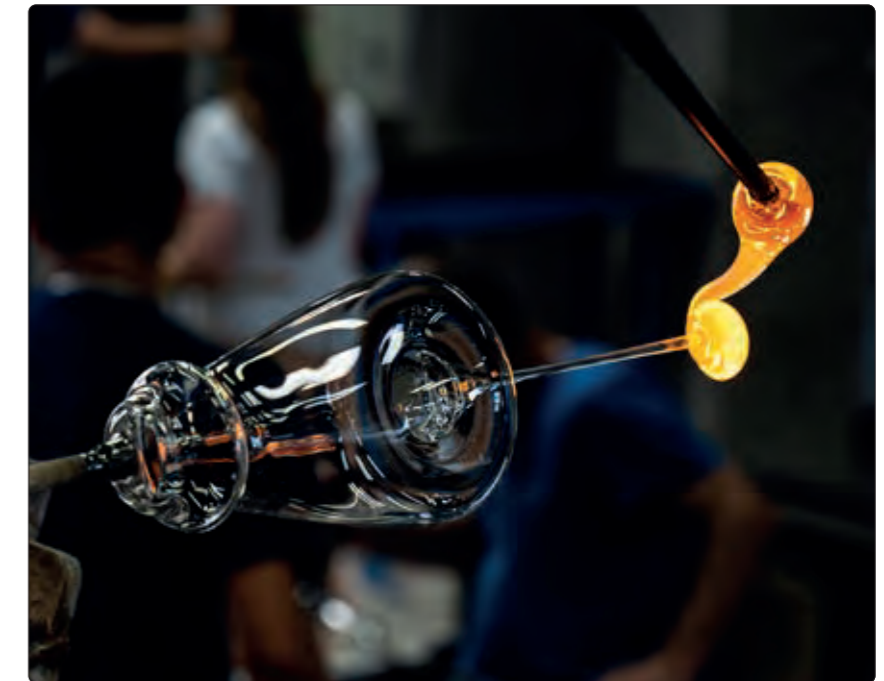

Innovative design

The VISION range is guaranteed to provide a highly sophisticated and fascinating design, accompanied by a unique aesthetic perception. The shape of the chalices and waveform of the bottom enable a maximum presence of aroma and optimum development of the wine.

Maximum presence of aroma

The VISION series provides perfect wine enjoyment: intuitive, uncomplicated and always in accordance with your own desires. However, it is particularly the fascination of the light, the colours, the refraction and the visual depth, that make it impossible to tear your eyes away from the glass, because:

You have never seen wine like this before!



▶ Filigree craftsmanship



wine glasses VISION



content approx. 340 ml
diameter 8 cm
height 24 cm

№ 5480.01
PU 2 pieces
EAN 4023174211535

№ 5480.01-1
PU 1 piece
EAN 4023174301892

FRESH

For extremely fresh white wines, Prosecco or any variety of sparkling and light rosé wines; with effervescent point

The wide opening of this glass allows the carbon dioxide in sparkling wines to gently evaporate. This prevents the aroma perception of the nose from being broadsided by a concentration of carbon dioxide, which is often the case with classic sparkling wine glasses. The glass provides the palate with a centralised aroma concentration, which allows the wine to express its exquisitely lively, refreshing and light character. The development of the flavour-carrying, fresh acidic structures is encouraged and individual features of the bouquet are brought into focus. The effervescent point at the bottom of the goblet creates a fine string of rising carbon dioxide bubbles in sparkling wine.



content approx. 540 ml
diameter 9 cm
height 27 cm

№ 5480.02
PU 2 pieces
EAN 4023174211542

№ 5480.02-1
PU 1 piece
EAN 4023174301922

STRAIGHT

For pure grape varieties and fruity / aromatic red and white wines

The characteristics of the wine are reflected harmoniously one-to-one in this glass. The authenticity of the aromatic culture of a grape variety is made discernible and presented in an unpretentious way, which makes this glass particularly suitable for all types of authentic grape varieties such as Riesling or Sauvignon Blanc. Light, aromatic red wines are transformed into pure drinking enjoyment.



content approx. 640 ml
diameter 10.5 cm
height 28 cm

№ 5480.03
PU 2 pieces
EAN 4023174211559

№ 5480.03-1
PU 1 piece
EAN 4023174301908

INTENSE

For opulent, great growth, powerful white and red wines, rustic, acidic white and red wines, young and middle aged Bordeaux wines

The tapering neck of this glass intensifies the aroma molecules, which are positively hurled out of the glass. The acidity is harmoniously structured in the fruit bouquet and completes the opulent overall sensation of strength. The glass provides intensive oxidation, making it ideal for any wine that can be decanted or served in carafes.



content approx. 850 ml
diameter 12 cm
height 25 cm

№ 5480.04
PU 2 pieces
EAN 4023174211566

№ 5480.04-1
PU 1 piece
EAN 4023174301915

BALANCED

For white and red Burgundy, great Piedmontese wines, highly complex but sensitive white and red wines, extremely opulent rosé wines and old vintage champagne

A perfect glass for wine that is not for decanting because of its sensitive structure, but still requires a great deal of air. This crystal emanates pure consonance. Even with discordant wines, it succeeds in creating a concentrated and highly elegant impression. This glass turns wine into a complete aromatic experience, without overdoing it.



content approx. 280 ml
diameter 7 cm
height 23 cm

№ 5480.05
PU 2 pieces
EAN 4023174211573

RICH

For fortified, sweet and dessert wines and any type of distilled beverages

A glass for the majority of heavyweight or high-proof drinks. The small presentation surface ensures that the wine or brandy does not become overly concentrated, so that the heavyweight aromatic elements are released in a nuanced way. Due to the glass having a narrow opening, the nose cannot go in very far, which prevents the perceiving mucous membranes from receiving a barrage of alcohol.



content approx. 250 ml
diameter 10.5 cm
height 16.5 cm

№ 5480.06
PU 2 pieces
EAN 4023174211580

NOSTALGIC

For cocktails or as a food glass

The wide chalice is perfect for stylish presentations of creative cocktails, spectacular hors d'oeuvres or sophisticated sweets. In combination with SIDE ideal for plain water, for easy service distinguishing both types of water.



content approx. 480 ml
diameter 9 cm
height 10.5 cm

№ 5480.07
PU 2 pieces
EAN 4023174301885

SIDE

For carbonated mineral water and soft drinks

Complementing the wine glass series, this glass is the tasteful companion for a stylish presentation of carbonated mineral water and soft drinks. The carbon dioxide is harmonised and the acids and mineral elements of fine sources are delivered to the tongue and the palate in a refreshing way, without being intrusive.

Votes by wine experts



"Zieher glasses manage to enhance the wine with an elegance and delicacy that is unmatched"

Emanuele Trono
@enoblogger, Italy



"Tasting a wine in a Zieher glass means living a unique sensory experience where all the characteristics of the wine are perfectly enhanced."

Andrea Zigrossi
@trotterwine, Italy



"Zieher glasses open new facets and show wine in a completely different way."

Christian Müller, winery Max Müller I
Volkach, Germany



"The world's best wines, served in a Zieher glass, are the perfection of my menus!"

Christian Senff, restaurant Aureus
Frankfurt, Germany

Vision wine glasses and Zieher decanters can be experienced in exclusive bars e.g. • Wein Kultur Bar, Dresden, DE • Weinbar KaDeWe, Berlin, DE • Restaurant & Bar Porte Noire, London, GB or top class restaurants e.g. • Dötzers Restauration, Bayreuth, DE • Estancia Beef Club, Dresden, DE • Wijnhotel Valckenburg, Valckenburg, NL • Landhaus Gräfenenthal Peter Lauterbach, Bindlach, DE • Knife & Spoon, Ritz Carlton, Orlando, Florida, USA • Akrame, Paris, FR and many more



▶ Valuable information about the care of the VISION glass series

No 5664 (page 12)

Care instructions VISION

To maintain the attractive appearance of the glasses for as long as possible, we recommend washing by hand. If you do use the dishwasher, we suggest the following:

- Select the shortest possible rinsing cycle at low temperatures, use a cleaning agent that is suitable for glasses and ensure that the water hardness is between 4 and 6.
- Remove your glasses from the dishwasher as soon as the rinsing cycle is completed, if possible.
- Polish your glasses with half-linen or microfibre towels for the best result. Cotton towels may leave small scratches and traces of lint.
- It is best to use 2 cloths for drying. This way you can polish the glass from the inside and outside at the same time. Please avoid to turn at the base, as this may cause the stem to break.



For further information please visit: WWW.ZIEHER-VISION.COM



No 5478

diameter 9 cm
height 2.3 cm

PU 2 pieces
EAN 4023174302950

TESORO – an aid to wine enjoyment

Noble wine glass lid that preserves volatile aromas and creates a complete wine experience.

The exceptional

- Preserves volatile wine aromas in the glass
- Elegantly protects against foreign bodies and flying insects
- For serving wine-accompanying snacks

Material

Borosilicate glass, hand-blown, dishwasher-safe

Delivery contains: 2 pieces

 In black gift box

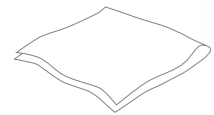

Glass polishing cloth

Premium polishing cloth made of microfiber. Ideal tool for scratch-free and lint-free polishing of wine glasses and decanters.

The exceptional

- Easy-care microfiber
- Washable at up to 90 degrees celsius, without using fabric softener, please follow the care instructions
- Scratch- and lint-free
- For streak-free glasses

Material

Microfiber

Delivery contains

1 polishing cloth in polybag

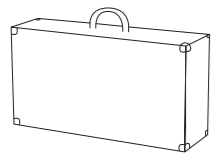

VISION presentation case

Sturdy hard-shell case with a foam insert precisely fitting for all glasses of the VISION series. Ideal tool for presenting the glasses to interested parties on site. Price for end-customers on request.

Delivery contains

- Glass series VISION:
1x FRESH, STRAIGHT, INTENSE, BALANCED, RICH, NOSTALGIC, SIDE
- 1 Zieher microfiber polishing cloth
- 1 pair of cotton gloves
- Information flyer: Zieher wine glasses and decanter

No 5664

size 43.5 x 70 cm

PU 1 piece
EAN 4023174302455

No 5661.02

size 65 x 34.5 x 18 cm

PU 1 piece
EAN 4023174302745

TESORO - THE FLAVOUR PRESERVER



an aid to wine enjoyment

Tesoro

The product:

The "Tesoro" wine glass lid preserves the volatile aromas and fits on every VISION wine glass. At the same time, it protects the wine from flying insects and other foreign bodies.

The lids are made of high-quality borosilicate glass, which originates from the laboratory sector and is known for excellent chemical resistance and high light transmission in combination with a flawless surface quality. The break-proof glass can easily be cleaned in the dishwasher and is odourless - the basic requirement for preserving the aromas of the wine.

No 5478 (page 12)

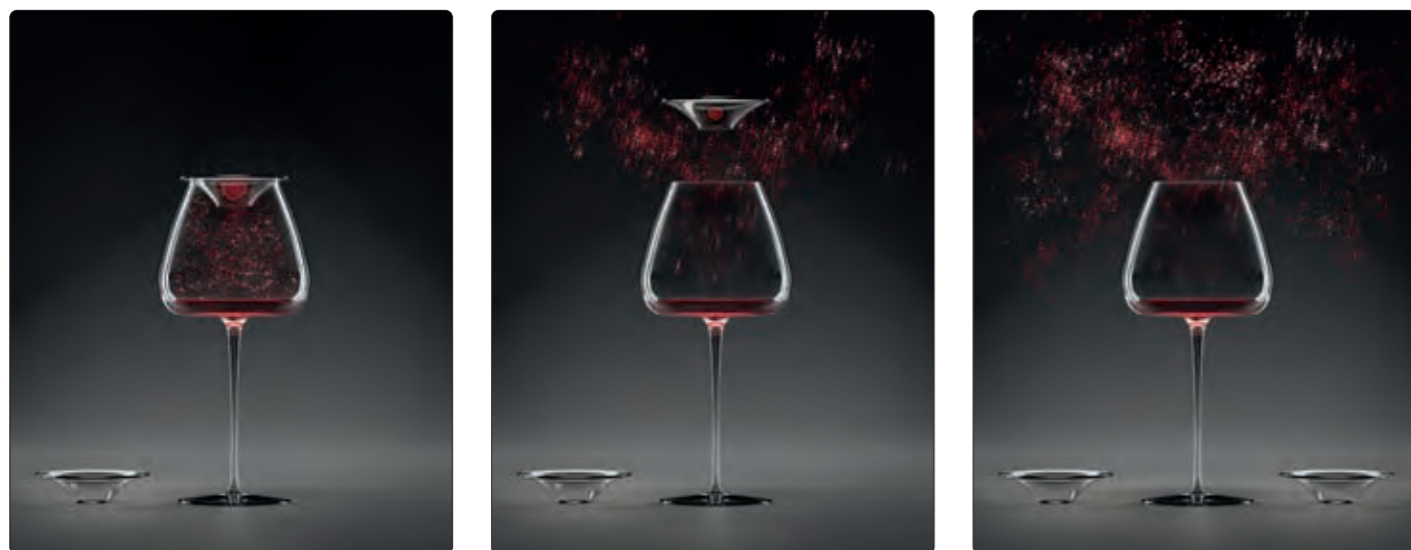

The function:

Inside a wine glass, a microcosm of different aroma molecules is created. The variety of primary, secondary and tertiary fragrances emanates from a wine glass in several stages and cannot be enjoyed in interplay.

The "Tesoro" lid preserves the volatile aromas within the glass. The wine does not develop more slowly, but the fragrance molecules, which normally vanish, can be perceived gradually or together - at your own discretion. Thus the little enjoyment helper enables a completely new wine experience.

Tapas culture:

Tapas (lit.: small lids) meanwhile have become a gastronomic concept. According to the actual literal origin, you can arrange accompanying snacks and sweets on the "Tesoro" and serve them to your guests with the wine glass.



Beguiling aroma variety

“It's not just a wine glass lid, it's about capturing transience. Hardly anything is as volatile as the wine aromas that escape from an open bottle or a filled wine glass. It happens automatically and naturally. It is irreversible and, in retrospect, often leaves a feeling of regret for not being able to capture the moment.

Sometimes it's in fact the small and inconspicuous things that leave a particularly big and lasting impression - like the "Tesoro" wine glass lid.

It creates wine experiences you have never before consciously and obviously perceived.”

Silvio Nitzsche
WEIN | KULTUR | BAR, Dresden



Putting the rule to the test:

Take two glasses of the same kind. Now fill both of them equally. "Seal" one of the glasses with "Tesoro" and leave the other one open. Wait for just five minutes and then smell both glasses.

Both wines will be identical in taste! This reflects the development passed through by the opened wine nevertheless. Note the variety of aromas, which you can absorb and analyse in the glass previously closed with the lid. You will be astonished and will probably never want to enjoy a wine without "Tesoro" again.

WINE DEVELOPMENT WORKERS



Star



Doppio

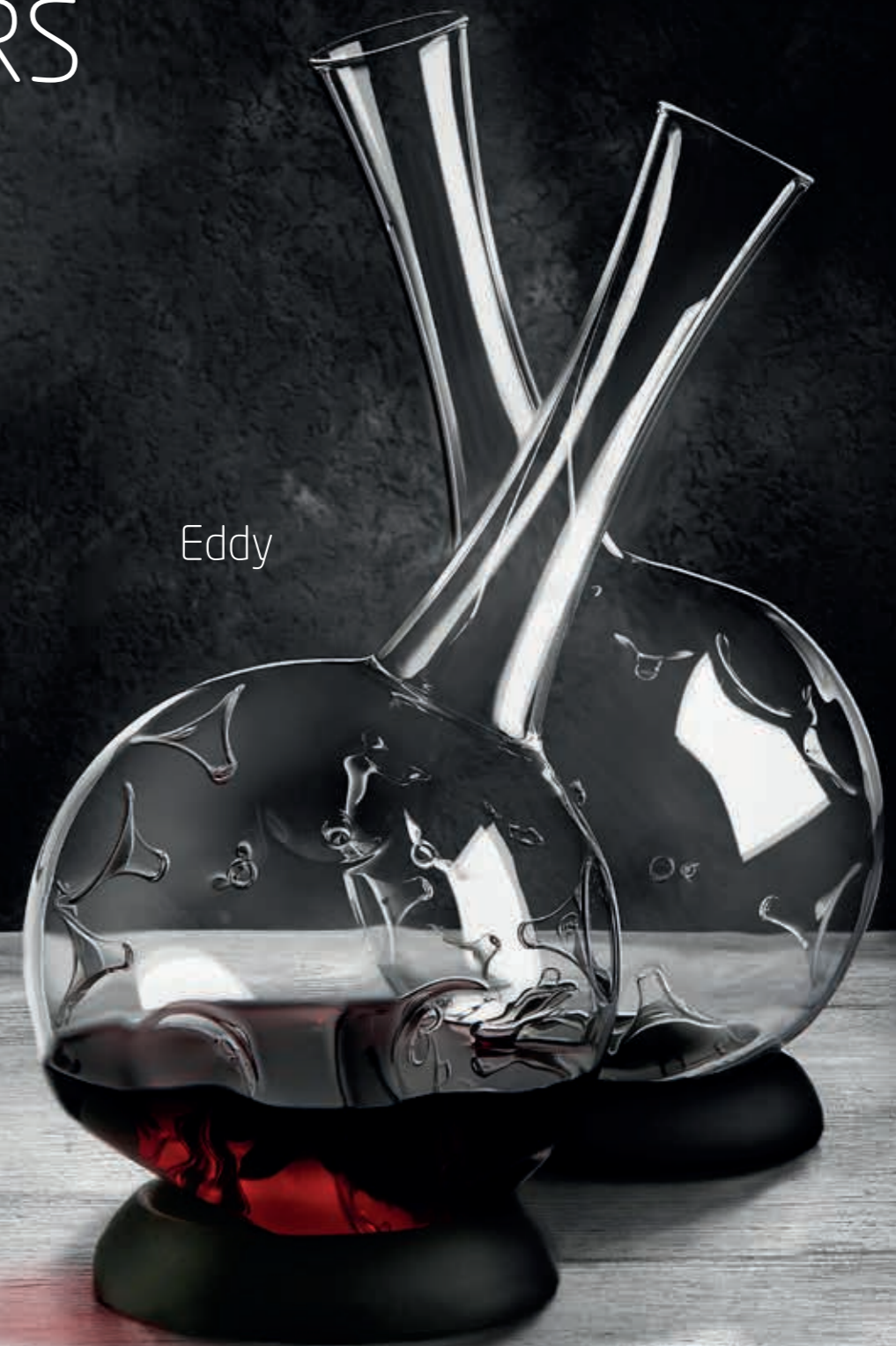

Eddy

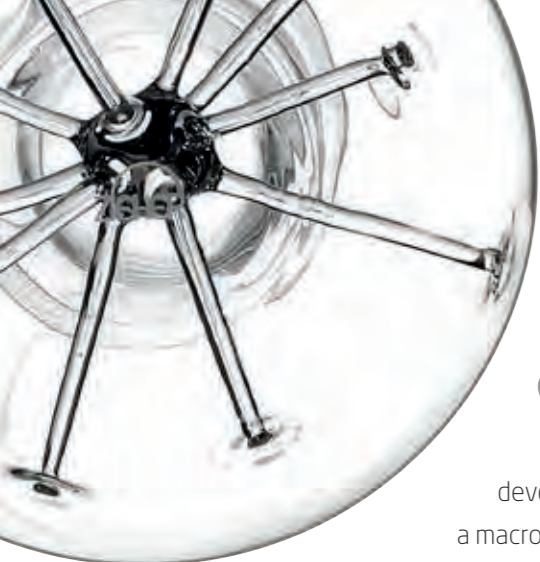

decanter/carafe Star



reddot winner 2020

” Many decanters provide a fast but completely unbalanced development of wines, as they only develop by a macro-oxidation on the surface.

It is more balanced and harmonic to implement the necessary oxygen in a very soft and gentle way. The filigree rays of the centric star animate the served wine to a very soft enhancement. During the slewing the oxygen is mildly folded in and integrated into the wine. Thus the wine starts to develop on its own terms and not – as with other decanters – just on the surface. By using borosilicate glass as raw material for this decanter, which stands out by its extremely smooth surface, another highly pleasant effect is created: the aromatic molecules are not expelled from the wine but allowed to present themselves completely in the wine glass. The aerated wine becomes extremely balanced, carefully crafted and centered. An additional value, which is simply priceless!”

No 4948.PB (page 22)



Silvio Nitzsche
WEIN | KULTUR | BAR Dresden



You can find more information about the wine decanter "Star" at www.zieher-selection.com/en/star/

No 4945.PB (page 22)



The big "Star" has a recessed grip at the bottom, which improves the swirl during filling and slewing. On the other hand, it guarantees a safe handling and firm stand while serving the wine. A black silicone base ring, enclosed in the present box, offers an attractive base and allows inclined positioning of the decanter.

The small "Star" is particularly suitable for the decantation of wines by the glass or small bottles. The ideal charge to provide a maximum of oxygen is 0.375 ltr. The reduced size allows to decant white wines and still to temper them in wine coolers. Also for dessert wines, the staging of innovative high-end cocktails, flavoured spirits, to the point of exotic juices – this unique product is the perfect solution.

THE ART OF DECANTING

The decanter "Star" synergises the aesthetics of a unique copy with the functionality of a professional tool for vinophile pleasure. The individual star raises each carafe to an exceptional piece. This artfully created centerpiece becomes a unique element in an excessively complex multi-stage process. This is pure luxury in our uniform world, because not a single "Star" is of the same kind.



No 4948.PB

No 4945.PB



decanter/carafe Eddy

The volume of the big "Eddy" has been dimensioned in a way that, with a filling of up to 1.5 litre, the extension of the wine's surface becomes as large as possible. Due to the flattened bottom, this respirator stands safely and straight, the enclosed collar made of matt black silicone also allows an inclined positioning.

The small "Eddy" is perfectly suitable for the decanting of wines by the glass or little bottles. Thereby the ideal charge to maximise the content of oxygen is 0.375 litre. The compact design is perfectly suited to decant white wines first and then to temper in a wine cooler. By the extravagant character of these design elements, even high-end cocktails and other exotic creations can be staged appropriately.

The basic material for this development worker for wine is extremely robust, high-grade borosilicate glass. This type of glass, which stands out due to its dense structure, extraordinary transparency and hardness, is the precondition for the implementation of the introversive swirl elements. In an interplay with light and the contained wine, they also create visually interesting colour reflections and almost graphic effects.



No 4884.PB (page 23)



drying rack (page 32)

No 4891.PB (page 23)

DESIGN
Silvio Nitzsche

BREATHE DEEPLY!

“ The decanter “Eddy” defines the world of extreme wine instruments in a completely new way. Their functionality has seldom been united with an aesthetic language of design in such a spellbinding way. The matchlessly fast-paced development of structure, which all wines undergo in that respirator, is really fascinating! Once rotating in this texture stimulator, due to the thousandfold swirls at the conical indentations, the wine goes through a process, whose behavior is equivalent to an oxidation reaction of several hours, within a few seconds.”

Silvio Nitzsche
WEIN | KULTUR | BAR Dresden

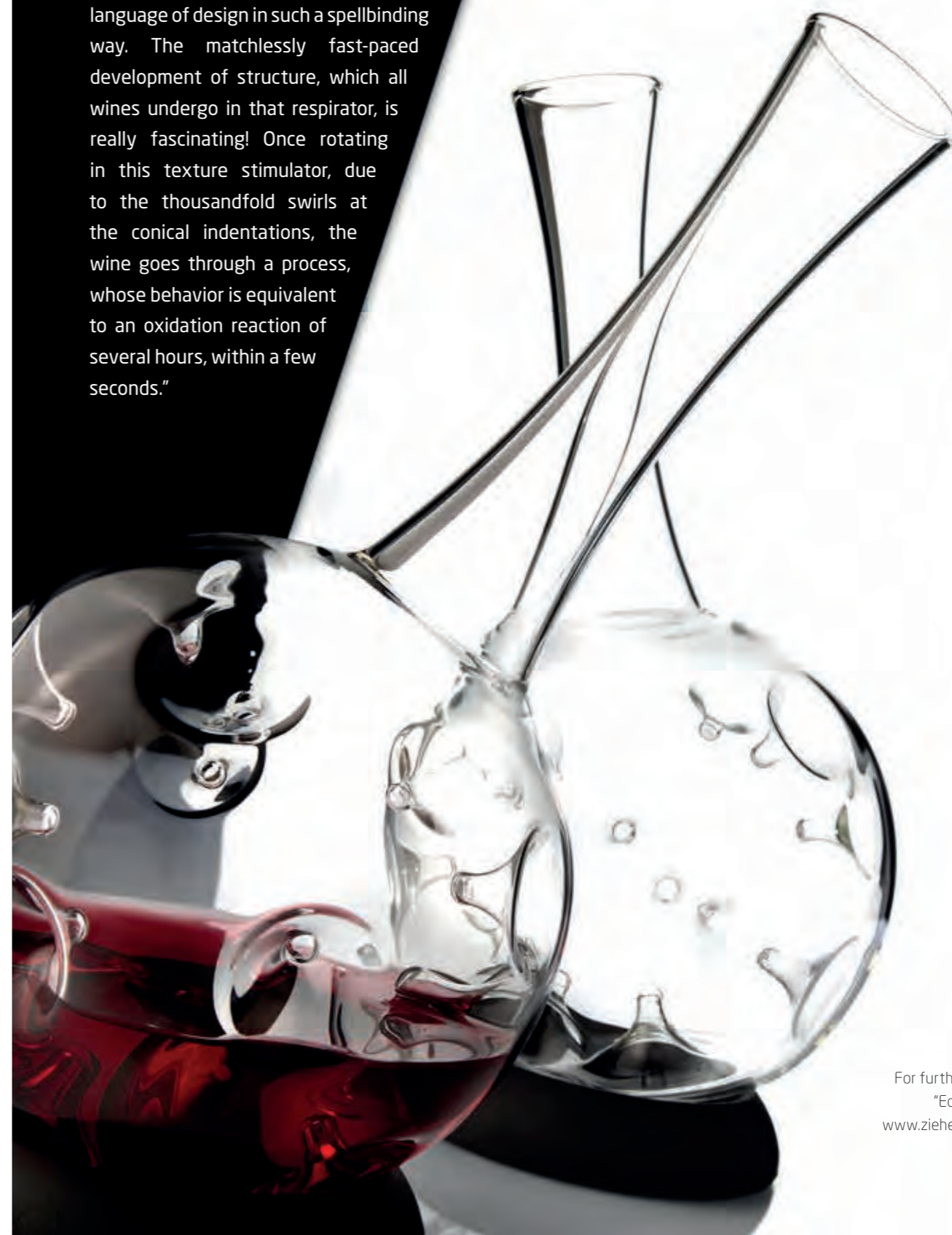

For further information about the "Eddy" decanter please visit www.zieher-selection.com/en/eddy

decanter/carafes



recessed grip at the bottom for better handling!

No 4948.PB



content bowl diameter approx. 1.8 L
15.5 cm
total height 34 cm

PU 1 set (2 parts)
EAN 4023174301328



"STAR" THE GENTLE

The individual star in the centre of the "Star" decanter integrates the oxygen in the interior of the wine by gentle swings. The wine develops the aroma very gently and balanced from its inside and not, as with other decanters, at the surface only.

The exceptional

- Worldwide the first decanter of this kind!
- No "Star" looks alike!
- Each piece is unique - created by craftsmanship
- An integrated recessed grip at the bottom provides easy and safe handling during the service

Ideal charge for a maximum of aeration
0.75 litre

Material

- Decanter: high-grade borosilicate glass, robust and easy to clean
- Base: matt black silicone, guarantees a firm stand and allows an inclined positioning

Delivery contains: 1 decanter with base

In black gift box

"STAR" - mini THE ALLROUNDER

The reduced size is perfectly suitable for the decanting of wines by the glass and small bottles. Additionally, it offers the possibility to decant white wines and to temper them in a cooler. Also suitable for dessert wines, the staging of high-end cocktails, flavoured spirits, exotic juices and other delights to the palate.

The exceptional

- Reduced size for manifold usage
- No "Star" looks alike!
- Each piece is unique - created by craftsmanship

Ideal charge for a maximum of aeration
0.375 litre

Material

high-grade borosilicate glass, robust and easy to clean

Delivery contains: 1 decanter

In black gift box

"STAR" - mini & VISION "Straight"

The gift set to become familiar

The exceptional

The perfect combination of a gentle decanter for wines by the glass and small bottles (ideal charge max. 0.375 ltr.) and two glasses, which reflect the character of the wine harmonically one-to-one.

Delivery contains

1 decanter „Star“ - mini,
2 wine glasses VISION „Straight“ (page 8)

In black gift box

decanter/carafes



No 4884.PB

content bowl diameter approx. 2.3 L
17 cm
total height 35 cm

PU 1 set (2 parts)
EAN 4023174213652



"EDDY" THE RAPID

Inside the "Eddy" decanter, the wines pass a development in taste and structure by circulating and with manifold swirls in a time-lapse. Within seconds, the wine experiences a respiration, which normally can only be reached in a decanting process of several hours.

The exceptional

Introverse swirl elements provide a rapid development of the wine structure during the slewing process.

Ideal charge for a maximum of aeration
0.75 to 1.5 litres

Material

- Decanter: high-grade borosilicate glass, robust and easy to clean
- Base: matt black silicone, guarantees a firm stand and allows an inclined positioning

Delivery contains: 1 decanter with base

In black gift box

"EDDY" - mini THE COMPACT ONE

The small "Eddy" is perfectly suitable for the decanting of wines by the glass or small bottles. Thereby the ideal charge to maximise the content of oxygen is 0.375 ltr. The compact design is perfectly suited to decant white wines first and then to temper in a wine cooler.

The exceptional

- Reduced size for manifold usage
- Introverse swirl elements provide a rapid development of the wine structure during the slewing process

Ideal charge for a maximum of aeration
0.375 litre

Material

high-grade borosilicate glass, robust and easy to clean

Delivery contains: 1 decanter

In black gift box

"EDDY" - mini & VISION "Straight"

The gift set for wine enjoyment for two

No 4892.PB

content glass diameter glass approx. 540 ml
9 cm
height glass 27 cm

PU 1 set (3 parts)
EAN 4023174301847



The exceptional

Spontaneous pleasure with a decanter, which allows the intensive development of wine structure at an accelerated pace (ideal charge max. 0.375 ltr.) and combined with 2 glasses, which reflect the character of the wine harmonically one-to-one.

Delivery contains

1 decanter "Eddy" - mini,
2 wine glasses VISION "Straight" (page 8)

In black gift box

SPOT ON!

Base ring with LED light

This base ring for the "Eddy" (item 4884.PB) and "Star" (item 4948.PB) decanters offers the chance to put served wines into the spotlight by illumination.

The rechargeable Zieher LED light fits exactly into the cavity at the bottom part of the ring and thus can put the served wine in the limelight from inside the decanter. In the beginning, the illumination effect inside the filled decanter can be very unobtrusive, when serving strongly pigmented red wine. But at a decreasing level, the play of light and colours becomes more and more intense in an exciting way.

The gift set is an effective accessory for the Zieher decanters "Eddy" and "Star" and comprises besides the ring, made of matt black silicone, also the light, remote control and the charger.

LED light and remote control offer various functions, such as adjustable brightness, 7 different colours and various colour-changing functions.

Detailed information about the Zieher rechargeable LED light can be found at the following link:
www.zieher-selection.com/akku-led



rechargeable LED

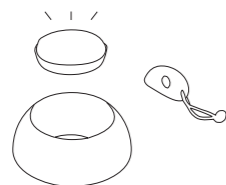

BASE RING WITH LED LIGHT

The base ring for the Eddy (item 4884.PB) and Star (item 4948.PB) decanters offers the chance to put served wine into the spotlight by illumination.

The exceptional

Compatible with "Star" 4948.PB (page 22) + "Eddy" 4884.PB (page 23)

Delivery contains

1 ring, 1 LED light, 1 charging station (EU-power plug), 1 remote control

Please note: UK/US-power plugs are available on request

In black gift box

№ 8153.01PB

height ring
diameter ring
power plug

5.5 cm
15.2 cm
Europe

PU
EAN

1 set (4 parts)
4023174301427

CARVED IN STONE

On hot days, decanting wine while keeping it at the optimal drinking temperature can be quite a challenge. The decanter cooler "On The Rocks" offers an innovative and highly aesthetic solution for this situation.

"On The Rocks" has been exclusively designed for Zieher decanters "Eddy" (4884.PB) and "Star" (4948.PB). The selected gray marble is captivating due to the diverse patterns of its marbling. Each piece is unique and offers the opportunity to decant and simultaneously chill white, rosé, and red wines in a stylish manner.

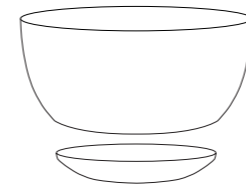
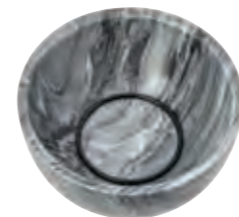

№ 8059.PB

content
diameter
total height

approx. 1.4 l
approx. 20.5 cm
approx. 11 cm

PU
EAN

1 set (4 parts)
4023174304558



№ 4948.PB (page 22)

"ON THE ROCKS" DECANTER COOLER SET

The top part of the cooler (suitable for decanter "Eddy" and "Star") is stored in the freezer, while the matching base remains unchilled. It captures the condensation that forms on the frosted top part during use, ensuring that the table remains dry and free from unwanted water stains.

The exceptional

The frozen bowl ensures that the wine maintains the desired drinking temperature for longer on hot days. Two silicone rings dampen noise and protect the decanters when inserted into the cooler.

Material: Polished marble/silicone

Delivery contains

1 bowl and 1 saucer made of marble,
2 silicone rings compatible with "Star" 4948.PB (page 22) and "Eddy" 4884.PB (page 23)

Please note:

Marble is a natural product, which means that the grey marbling can vary strongly. This is exactly what creates the vivid and unique look of this natural stone. Specific groceries, especially those that contain fruit acid (citric acid), may damage the surface in case of longer contact. Therefore we recommend avoiding direct contact with edibles. Please clean only with a wet cloth and gentle cleaners. Not dishwasher-safe.

In black gift box

decanter/carafe

Doppio



No 5480.04 (page 9)

DESIGN

Itamar Harari



No 4894.PB (page 30)

In the "Doppio" decanter, wine is given a double stage that attracts attention and provides surprising effects.

The geometric silhouette and the reduced design appears almost technical and direct the view to the inside, because the whole secret of this extraordinary design only discloses in filled condition.

Attractive visual effects appear already during the pouring process when the wine spreads onto both levels of the "Doppio" decanter. It almost seems that the wine is levitating.

In addition to the natural flow of the wine, which pours over the inside of the decanter onto the two levels, the division into two levels also has an extremely beneficial effect on the development of the wine. The splitting creates a significantly larger surface of the wine with a comparatively small space requirement on the table, which maximises the possible oxygen contact. The division also remains when pouring out, so that the cascaded flow creates a waterfall effect, which additionally increases aeration through swirling.

"Doppio" is elaborately handcrafted from high quality borosilicate glass, which is robust and easy to clean. The ideal charge of the decanter is 0.75 litre in order to generate maximum oxygen contact and the most beautiful optical effects.

MAY IT BE
SOMETHING
MORE?



wine decanter

Pebble



drying rack (page 33)



No 5480.04 (page 9)

No 4890.PB (page 30)

FORMED
BY HAND!

Pebble

"Pebble" is made of high-grade lead-free crystalline glass. The unfilled decanter inspires by the brilliance of the glass alone and the resulting light reflections. This product is hand-blown with perfect craftsmanship. The sensitivity and longstanding experience of the glass blowers become apparent in particular in the creation of the bottom, which is extensively dimensioned and separated into three convex segments.

DESIGN

Itamar Harari



Due to the shaping of the neck, the wine flows along the entire inside area while filling the decanter, which maximises the surface of the wine and thus contributes to the aeration. The three swales at the bottom serve to further swirl the poured wine, which results in a gentle but nevertheless very effective aeration. This effect can be intensified by warily swinging the filled decanter. Furthermore, the three bulges at the bottom provide a wiggle-free and safe stand. The diagonal cut of the neck and the accurate polish of the raw edges minimise the formation of drops while pouring out.

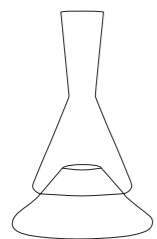

№ 4894.PB

content approx. 1.75 L
diameter 20 cm
total height 30 cm

PU 1 piece
EAN 4023174302271

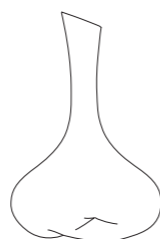

№ 4890.PB

content approx. 1.8 L
diameter 20 cm
total height 30 cm

PU 1 piece
EAN 4023174300871



"DOPPIO" THE DOUBLE STACK

When pouring into the "Doppio" decanter, the wine is distributed over two levels, creating appealing visual effects and maximising the oxygen contact of the wine through the significantly enlarged surface. The division into two is retained even when pouring out and intensifies the ventilation through additional swirling.

"PEBBLE" THE CLASSIC

The handblown decanter in classical shape results from the high craftsmanship of experienced glass blowers. The shaping of the neck, the bell-bottomed body and the three dents, integrated in the bottom, already provide a maximisation of the surface during the pouring. Thus the maximum possible contact with oxygen and at the same time, a mild development of the wine can be achieved.

The exceptional

- The first decanter of its kind worldwide!
- Innovative design concept with filling on two levels for more oxygen contact
- Each piece is unique - created by craftsmanship

Ideal charge for a maximum of aeration: 0.75 litre

Material: High-quality borosilicate glass, robust and easy to clean

Delivery contains: 1 decanter

In black gift box

The exceptional

Inducted by the shaping, the wine runs along the complete inner surface already during the filling. Three dents in the bottom provide a gentle swirl and a soft aeration. This effect can be intensified by a soft slewing.

Ideal charge for a maximum of aeration: 0.75 to 1.5 litre

Material: High-grade lead free crystal glass

Delivery contains: 1 decanter

In black gift box

Creating a useful tool with a high demand on aesthetics - this was the idea during the development of "DryPod". The solid rack made of brushed stainless steel, either black or brass coloured, forms the basis for this shapely product. An accurately fitting drip tray, made of translucent resin, is placed inside the rack and harmonises with its anthracite colouration with both variants.

Primarily "DryPod" is a drying rack for decanters. The geometry was chosen in a way that all Zieher decanters can be placed safely, besides the big variations of "Eddy", "Star", "Doppio" a.s.o., it can also take hold of the smaller versions of some types as well as many other decanters in classical format. The drip tray securely collects dripping water and can be easily removed for cleaning.

Even after drying, all decanters are well stored in "DryPod". No matter if in a showcase or on the shelf, the decanter is stylishly presented by the precious display. Here, the downward-pointing opening helps prevent dirt from getting in easily.



care instructions decanter

No 8014.20PB



Looking at "Doppio", "Star" or "Eddy", almost everybody who already gained experience with decanters, will intuitively ask how to clean them. Many decanters have the nature, in particular when used for red wines, to absorb the colour pigments and to show light grey or brown surface layers after a certain usage. Most of these carafes have microscopically seen a rough surface, where leftovers of the wine might adhere to and cause an unattractive appearance of the decanters.

With our decanters made of borosilicate glass, this effect might appear after a much longer period due to the extremely smooth and repellent surface of this high-quality laboratory glass. In case it actually happens, these traces can easily be removed by using a mixture of citric acid and water. After a 2 hour residence time, the problem should be solved.

Optionally available drying racks, made of stainless steel, facilitates the drying of the decanters after rinsing.

drying rack



drying rack

"STABLO" DRYING RACK

The optionally available drying rack facilitates the reverse positioning of the wet decanter and provides for a quick drying. The rack has been deliberately designed in a high-grade quality. If desired, it can also be used as a presentation display for the "Star" decanter (4948.PB). An accessory that really adds value.

The exceptional

Non-skid caps, made of matt black silicone, ensure a safe stand and keep the decanter in the desired position. Compatible with "Star" (4948.PB), "Eddy" (4884.PB), "Pebble" (4890.PB) and "Doppio" (4894.PB).

Material:

Highly polished stainless steel, silicone

Delivery contains:

1 drying rack

In black gift box

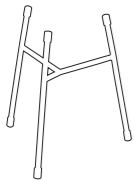

No 8014.20PB

total height 20 cm

PU 1 piece

EAN 4023174300857

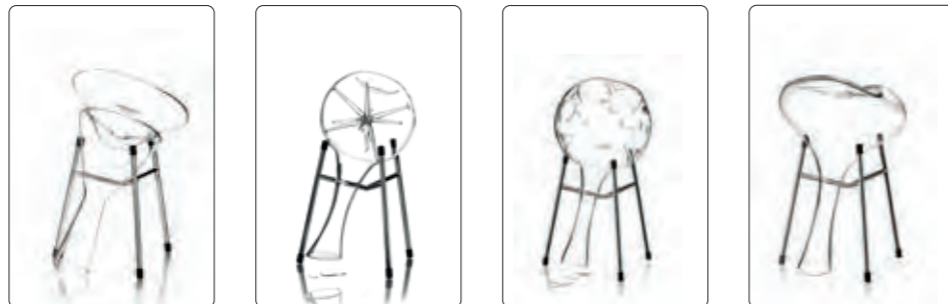

"DRYPOD" DRYING RACK

Placed on this elegant rack, all Zieher wine decanters can easily be dried top down after cleaning. Remaining humidity will be collected in a tray. Afterwards, the rack may also be used for a safe and stylish storage.

The exceptional

- Stylish tool for easy drying and safe storage
- Compatible with all Zieher decanters: "Star" (4948.PB), "Eddy" (4884.PB), "Pebble" (4890.PB), "Doppio" (4894.PB), "Star" - mini (4945.PB), "Eddy" - mini (4891.PB)

Material: Brushed stainless steel (PVD-coated), resin

Delivery contains:

1 drying rack

1 drip tray made of dark grey resin

In black gift box

No 2231.PB

colour brass coloured

height 26 cm

diameter 18 cm

PU 1 piece

EAN 4023174303636

No 2233.PB

colour black

height 26 cm

diameter 18 cm

PU 1 piece

EAN 4023174303629





Extravagant treasures packed in a stylish way

The products of the Zieher VISION series and the decanters are delivered in a matt black gift box.

Due to the elegant overall appearance, each VISION glass or each decanter convinces even before unpacking.

The folded, solid cardboard box assures safe and easy transportation.

Get to know VISION!

The wine glasses of the series are also available in individual packaging (pages 8 and 9).

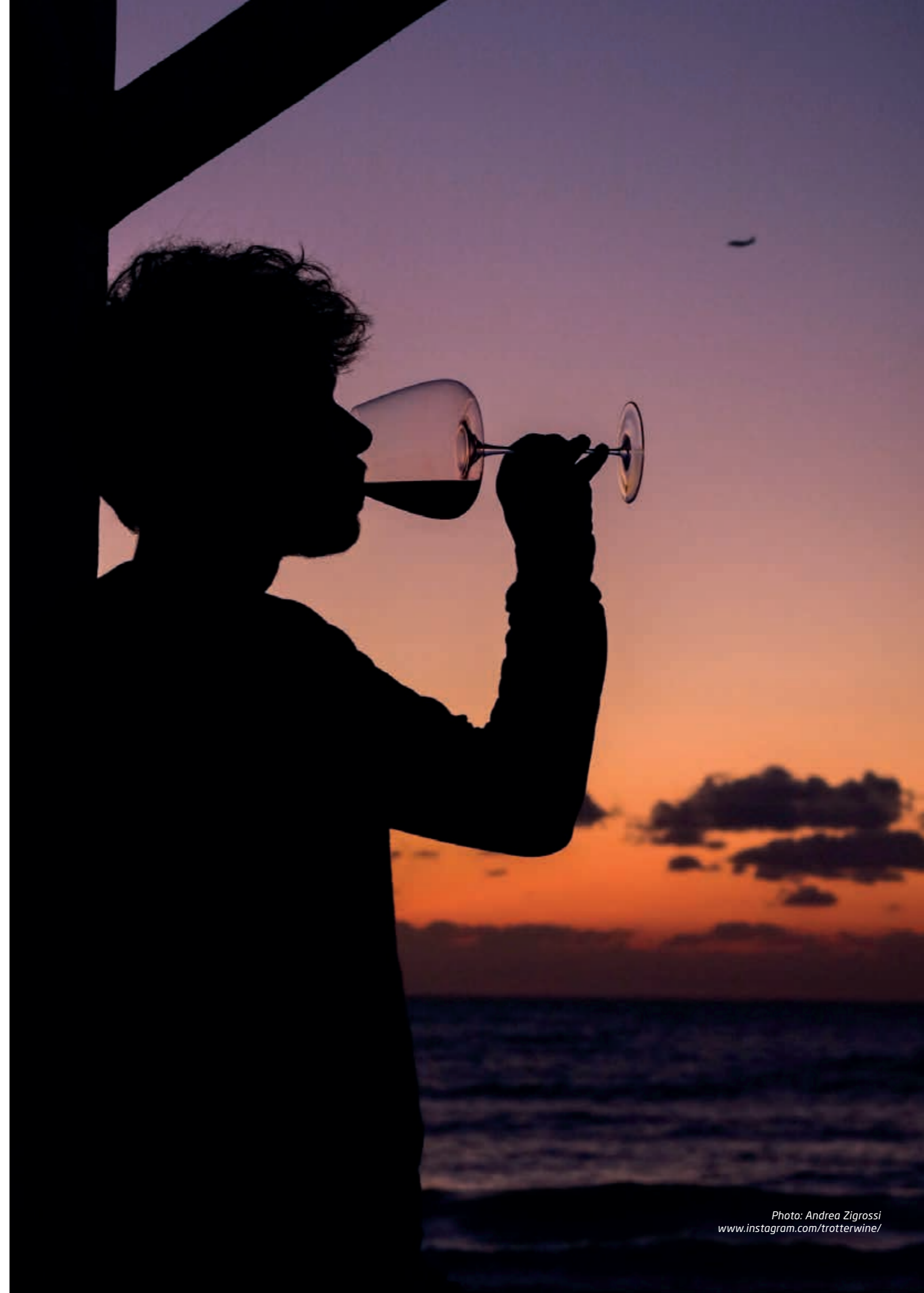

Follow us on social media and stay tuned!

Our partners, fans and friends, among them many top chefs and sommeliers from all over the world, are using Zieher products to stage drinks and dishes and to present them on social media.

Below is a great collection of very special Zieher moments.

Thanks so much for your creativity!

share your #ziehermoment

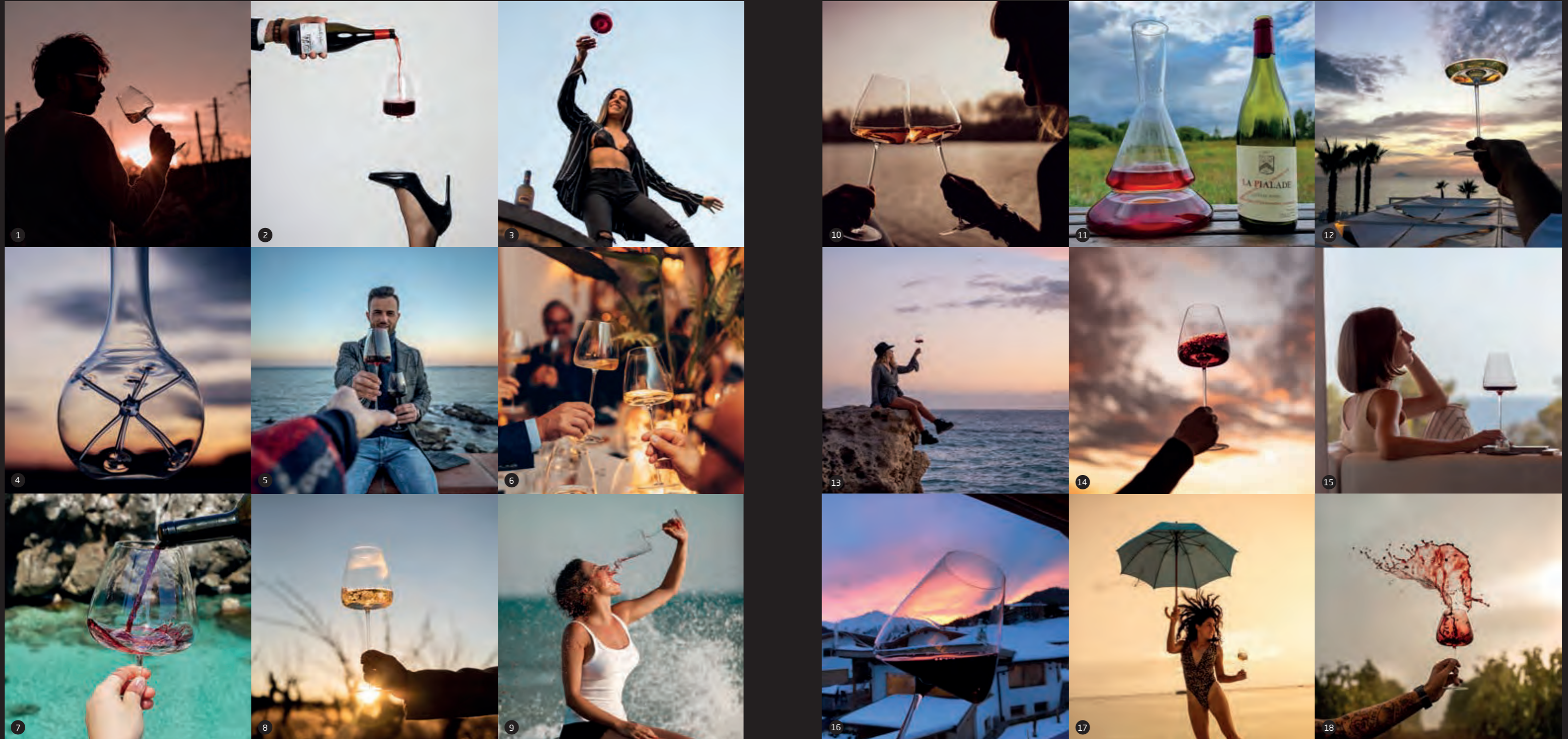

- ① ② Andrea Zigrossi, [instagram.com/trotterwine](https://www.instagram.com/trotterwine)
- ③ ⑧ ⑭ ⑱ Gilbert Bages, [instagram.com/drinkinmoderation](https://www.instagram.com/drinkinmoderation)
- ④ Diane Souquiere, [instagram.com/dalkia_loves_wine](https://www.instagram.com/dalkia_loves_wine)
- ⑤ ⑬ Phototannins, [instagram.com/phototannins](https://www.instagram.com/phototannins)
- ⑥ Konrad Lifestyle by DJ Antoine, [konradlifestyle.com](https://www.konradlifestyle.com)
- ⑦ Enrico Onthewine
- ⑨ Elisa Dublyansk
- ⑩ WeinBaum, [instagram.com/weinbaum.de](https://www.instagram.com/weinbaum.de)
- ⑪ Rasmus Christensen, [Winewherever](https://www.winewherever.com)
- ⑫ Francesco Ciardullo, [instagram.com/ciardulloofficial](https://www.instagram.com/ciardulloofficial)
- ⑮ Elena Vinyarskaya, [instagram.com/readmeawine](https://www.instagram.com/readmeawine)
- ⑰ India Donisi, [instagram.com/winespicegirl](https://www.instagram.com/winespicegirl)



Annika Hohmann, Germany
[instagram.com/the_hunting_wine_girl](https://www.instagram.com/the_hunting_wine_girl)

"Special about the VISION series is that we are talking about character glasses. We approach the wine individually through the glass and thus receive a much more intense experience of pleasure. The glasses are not only eye-catching but also enrich our palate."



Thomas Dötzer, Germany
www.doetzers.de

"From the very beginning, we have been excited by the appearance and the design of the glasses. But after the first degustation, we have been enthusiastic! We did not want to stop tasting. The wine simply gains a different character. The BALANCED glass makes decanting superfluous - and a Grappa out of the RICH glass is simply a great experience!"



Andrea Zigrossi, Italy
[instagram.com/trotterwine](https://www.instagram.com/trotterwine)

"I can say that my first encounter with Zieher glasses was "love at first taste". Finding glasses that enhance the tasting experience to the maximum is not easy, and the VISION Series succeeds in full! Thanks to the unique design and the lightweight material, the wine is excellently expressed making the tasting flawless."



Rasmus Christensen, Denmark
[instagram.com/winewherever](https://www.instagram.com/winewherever)

"The VISION series has a remarkable ability to bundle the fragrance, while providing an elegant and aesthetic appearance."



Ed Agg, Australia
[instagram.com/thecellarpost](https://www.instagram.com/thecellarpost)

"The Zieher VISION range is the marriage of exceptional design and an uncompromising approach to enhancing the wine experience. It's these characteristics that make the VISION range both a work of art, and the most precise, reliable, and exciting glassware one can own."



Elisa Dublyanska, Italy
[instagram.com/ilviaggioinuncalice](https://www.instagram.com/ilviaggioinuncalice)

"The INTENSE glasses from the VISION collection are my favourite! A perfect combination of quality, innovative design and elegance. They give a unique tasting experience."



Emanuele Trono, Italy
[Instagram.com/enoblogger](https://www.instagram.com/enoblogger)

"My experiences with the Zieher VISION series have been outstanding. The glasses praise the wine, they are extremely light, give expressiveness to the wine and are also a beautiful design object. They are a must-have for every wine lover and I also became Zieher-addicted."



Walid Romaya, USA
[instagram.com/princeofwine](https://www.instagram.com/princeofwine)

"As a wine influencer, I have tasted thousands of wines in all glass shapes and sizes. The INTENSE wine glass is the perfect balance of beauty and functionality. It is a piece of art in your hand, that delivers and intensifies the wine aromas and characteristics through its unique and beautiful bulbous base. When using the glass for wine tastings in bars, people literally flooded me with comments about its beauty. Simply spectacular and one of the best wine glasses I have ever tasted with."

Follow us
 on social media
 and stay tuned!



[instagram.com/Zieher_Selection](https://www.instagram.com/Zieher_Selection)



[facebook.com/Zieher](https://www.facebook.com/Zieher)



[youtube.com/user/ZieherGermany](https://www.youtube.com/user/ZieherGermany)



[xing.com/companies/zieherkg](https://www.xing.com/companies/zieherkg)



[linkedin.com/company/zieher-kg](https://www.linkedin.com/company/zieher-kg)



WWW.ZIEHER-VISION.COM

KATwine0324GB